



D GB F NL E P I DK N
 FIN EST CZ PL RUS H GR TR

1 - 7



8



9 - 11

Racing

12 - 19

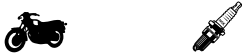

21 - 116



117 - 142



143 - 154



155 - 211



212 - 245

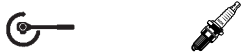

246

APS, BERU, BMW, BOSCH, BRISK, CHAMPION, DENSO, EYQUEM, HARLEY-DAVIDSON, HONDA, ISOLATOR, ITALJET, KAWASAKI, MARELLI, MEGA FIRE, OREGON, PAL, SPLITFIRE, SUZUKI, TORCH, YAMAHA → NGK

247 - 289



290 - 293



294 - 298

Quick-No. _____ → _____ Order-No. 299



Quick-No. 299 - 301

Quick-No. _____ → _____ Quick-No. 302 - 303



304 - 305



306 - 309

Anmerkungen (D)

Diese Anwendungsliste dient nur der Typenauswahl.

Mit Veröffentlichung dieser Ausgabe verlieren alle vorhergehenden Anwendungslisten ihre Gültigkeit.

Ein Rechtsanspruch kann aus dem Inhalt nicht begründet werden.

Empfehlungen gemäß der FAA-Richtlinien für Luftfahrttriebwerke sind in dieser Ausgabe nicht enthalten.

Die im Katalog aufgeführten Zündkerzen, Glühkerzen, Stecker können in den Motoren entsprechend unserer Katalogempfehlung verwendet werden. Erkennbarer Irrtum sowie offensichtliche Druckfehler unterliegen der Sorgfaltspflicht des Anwenders. Für die Fehlerfreiheit und die zugesagten Eigenschaften leistet NGK Gewähr entsprechend dem jeweiligen Stand der Technik. Grundvoraussetzung dafür ist die sachgemäße Handhabung der NGK-Produkte. Die Gewährleistungspflicht für Materialfehler oder mangelhafte Ausführung beträgt 24 Monate ab Kaufdatum, sofern die vom Fahrzeughersteller vorgeschriebenen Wechselintervalle nicht betroffen sind. Ausgenommen davon ist der normale Verschleiß sowie jeglicher Racingeinsatz.

Comments: (GB)

This application list is only valid for type identification.

This catalogue supersedes all previous catalogues.

We do not accept any responsibility in respect of legal claims arising out of the contents of this list.

Spark Plug recommendations regarding FAA guidelines for aeroplane power units are not included in this edition.

The spark plugs, glow plugs, and caps listed in our Catalogue can be used in the engines which we recommend in our catalogue. Recognizable mistakes, such as printing errors are subject to careful scrutiny by the user. NGK safeguards for accuracy and the mentioned characteristics in accordance with the current state of the art technology. Basic condition for this is the proper use of the NGK product. The seller's warranty period for faults in material or unsatisfactory performance is 24 months from the date of purchase, provided the prescribed interval changes from the vehicle manufacturer are adhered to. Excluded from this is normal wear and tear and any form of racing activities.

Informations: (F)

Ce catalogue doit être utilisé en tant que manuel de référence. Des bougies d'allumage plus froides ou plus chaudes devront être utilisées selon le style de conduite et l'usure du moteur.

La dernière version du guide NGK doit être consultée à tout moment, étant donné qu'elle contient les plus récentes caractéristiques de bougies et de moteurs.

Ce catalogue ne concerne pas les moteurs qui équiper les avions.

Les bougies d'allumage, bougies de préchauffage, embouts, mentionnés dans notre catalogue peuvent être utilisés dans les moteurs selon notre recommandation. Des erreurs reconnaissables, ainsi que des erreurs évidentes d'impression sont sous la propre responsabilité de l'utilisateur. NGK se porte garant quant au soin dans l'exécution ainsi que pour les qualités effectives correspondant à l'état respectif de la technique. La condition de base requise est une manipulation objective et correcte des produits NGK. Le délai de la garantie pour les défauts d'usinage ou d'usinage imparfait est de 24 mois à partir de la date d'achat, pour autant que les intervalles de services prescrits par le fabricant d'automobile ne soient pas mis en cause. Est également exclu de la garantie, l'usure normale, ainsi que toute application dans le domaine de la course automobile.

Opmerkingen: **NL**

Deze catalogus geldt alleen voor het uitzoeken van bougiereferenties.

Bij publicatie van deze uitgave komen alle vorige catalogi te vervallen.

Wettige aanspraak volgens FAA richtlijnen voor vliegtuigmotoren is in deze uitgave niet opgenomen.

The spark plugs, glow plugs, and caps listed in our Catalogue can be used in the engines which we recommend in our catalogue. Recognizable mistakes, such as printing errors are subject to careful scrutiny by the user. NGK safeguards for accuracy and the mentioned characteristics in accordance with the current state of the art technology. Basic condition for this is the proper use of the NGK product. The seller's warranty period for faults in material or unsatisfactory performance is 24 months from the date of purchase, provided the prescribed interval changes from the vehicle manufacturer are adhered to. Excluded from this is normal wear and tear and any form of racing activities.

Comentarios: **E**

Esta lista de aplicaciones es solamente válida para la identificación de los tipos.

Consulte siempre la última lista de aplicaciones.

No nos responsabilizamos de casos de aplicaciones que no estén incluidas en esta lista.

En esta edición no están incluidas las aplicaciones de bujías para motores FAA de aviación.

Las bujías de encendido, calentadores diesel y pipas de bujía que aparecen en nuestro Catálogo pueden utilizarse en aquellos motores que recomendamos en el mismo. Los errores reconocibles, como los de impresión, están sujetos a un reconocimiento exhaustivo por parte del usuario. NGK vela por la precisión y las características mencionadas de acuerdo con la tecnología de última generación. Una condición básica para ello es la correcta utilización del producto NGK. El período de garantía del vendedor en relación con defectos de material o rendimiento insatisfactorio es de 24 meses a partir de la fecha de compra, siempre y cuando se observen los cambios de intervalo prescritos por parte del fabricante del vehículo. Quedan excluidos de este punto el desgaste normal y cualquier forma de actividades deportivas.

Comentários: **P**

Esta lista de aplicações é válida apenas para a identificação de tipos.

Este catálogo substitui todos os anteriores catálogos.

Não nos responsabilizamos pelos casos de aplicações que não estejam contidos nesta lista.

Nesta edição não estão incluídas as aplicações de velas de ignição para motores FAA de aviação.

As velas de ignição, velas de resistência elétrica, e cachimbos apresentados no nosso Catálogo podem ser utilizados nos motores recomendados no próprio documento. Erros reconhecíveis, como gralhas, deverão estar sujeitos a cuidadoso escrutínio pelo utilizador. NGK garante a exactidão e as características mencionadas de acordo com a actual tecnologia de ponta. Uma condição básica para isso é a utilização correcta dos produtos NGK. O período de garantia do vendedor para defeitos no material ou performance insatisfatória é de 24 meses a contar da data de venda, sempre que se tenham respeitado os intervalos de mudança prescritos pelo fabricante do veículo. Desta garantia encontra-se excluído o desgaste normal do produto e qualquer forma de actividade competitiva.

Importante: **I**

Questo catalogo deve essere utilizzato come indicazione generica. Differenti condizioni di guida possono richiedere candele più fredde.

Questa edizione annulla quelle precedenti.

Non si assume alcuna responsabilità causata o derivata dal presente catalogo.

Le applicazioni di questo catalogo non devono essere riferite a motori installati su velivoli.

Le candele di qualsiasi genere, ed i cavi elettrici notati nel catalogo, possono essere inseriti nei motori da noi consigliati. Errori evidenti, o errori nel catalogo, devono essere controllati da colui che fa uso di questi pezzi. Per la correttezza delle informazioni ed attributi, la NGK garantisce nello standard tecnico di loro conoscenza. Requisito unico, è l'uso corretto delle informazioni tecniche. Il periodo di risarcimento è di 24 mesi a partire dall'acquisto. Questo verrà eseguito per materiale errato, fremo restando che i periodi d'intervallo non vengano toccati. Esclusi sono il normale consumo delle candele ed i kit Racing.

Kommentarer: **DK**

Denne anvendelsesliste kan kun bruges til type-identifikation.

Kun denne anvendelsesliste er gældende.

Der kan ikke gøres juridiske krav gældende på grund af denne liste.

Anbefalinger af tændrør til flymotorer i henhold til FAA retningslinjer er ikke indeholdt i denne udgave.

De tændrør, gløderør og tændrørshætter, der er anført i vort katalog, kan monteres i de motorer, som anbefales i kataloget. Tydelige fejl som f.eks. trykfejl bør nøje undersøges af brugeren. NGK garanterer for nøjagtighed, og at de nævnte egenskaber er i overensstemmelse med den nyeste, teknologiske udvikling. Den grundlæggende forudsætning herfor er korrekt brug af NGK's produkter. Garantien for fejl i materialer eller for utilfredstillende udførelse gælder i 24 måneder fra købsdato, forudsat at producentens foreskrevne udskiftningsintervaller er overholdt. Undtaget er normal slitage og enhver form for racing aktiviteter.

Kommentarer: **N**

Oplysningene i katalogen kan bare brukes til typeidentifikasjon.

Denne katalogen erstatter alle tidligere utgaver.

Innholdet i denne listen er ikke juridisk bindende.

Tennplugganbefalinger i forbindelse med FAA-retningslinjer for flymotorer er ikke tatt med i denne utgaven.

De tennplugger, glødeplugger og pluggetter som vises i katalogen, kan benyttes i motorer i henhold til de anbefalinger som gis i katalogen. Gjenkjennelige feil, slik som åpenbare trykkfeil, er underlagt brukerens undersøkelsesplikt. NGK garanterer for feilfrihet og de egenskaper som beskrives i henhold til gjeldende teknologisk standard. Forutsetningen for dette er at NGK produktet benyttes på en korrekt måte. Garantiperioden for materialfeil eller feilkonstruksjon løper i 24 måneder fra kjøpsdato, så lenge dette ikke kommer i konflikt med bytteintervallene som kjøretøysprodusenten opererer med. Unntatt fra dette er normal slitasje så vel som racingbruk.

Huomioitavaa: (FIN)

Tämän luettelon suositukset koskevat vain tyypiltään tunnistettavia moottoreita.

Tämä luettelo kumoaa ja korvaa kaikki aikaisemmat luettelot.

Emme vastaa minkäänlaisista tämän luettelon julkaisemisesta johtuvista korvausvaatimuksista.

Tässä luettelossa olevat syytystulppasuositukset eivät koske lentokoneisiin asennettuja FAA:n hyväksymiä lentokonemoottoreita.

Luettelossa mainittuja syytystulppia, hehkutulppia ja tulpan liittimiä voidaan käyttää vain moottoreissa, joita luettelon suositukset koskevat. Luettelon käyttäjän tulee noudattaa huolellisuutta ja kiinnittää huomiota havaittavissa oleviin, mahdollisiin virheisiin kuten painovirheisiin. NGK takaa tarkkuuden ja mainittujen ominaisuuksien yhdenmukaisuuden nykyisen, ajanmukaisen tuotantoteknologian mahdollistamalla tavalla. Perusedellytyksenä tälle on NGK-tuotteen oikea käyttö. Valmistajan takuu aika tuotteen materiaali- ja toimintavirheille on 24 kuukautta tuotteen ostopäivästä lukien. Takuun edellytyksenä on, että noudatetaan ajoneuvon valmistajan määrittelemää tuotteen vaihtoväliä. Takuu ei korvaa normaalista kulumisesta eikä mistään kilpailukäytöstä johtuvaa vauriota.

Tähelepanu: (EST)

Käesolev kataloog on ette nähtud ainult küünla tüübi määramiseks. Kataloogis antud küünalde sobivused ei ole siduvad / kohustuslikud. Samas ei vastuta tootja võimalike kahjude eest juhul, kui ei ole arvestatud käesoleva kataloogi soovitusi. Kataloogis antud soovitused ei kehti lennukitele paigaldatud, FAA poolt heaks kiidetud mootoritele.

Käesolevast kataloogist leiata süüteküünalde, eelsüüteküünalde ja küünlapiipude sobivuse, mis on ranges koostöös vastava mootori tootja nõuetega. Kuna NGK on paljudele suurtele autotootjatele süüteküünalde esmavalmistaja on tagatud toote kõrge kvaliteet ja valmistamise täpsus. Müüja poolne garantiiperiood materjalivigade või mitterahuldava töötamise osas on 24 kuud toote ostmise hetkest, eeldusel et täpselt on järgitud tootjapoolset süüteküünla soovitusetabelit ja vahetusintervalli. Arusaadavalt ei kuulu garantii alla süüteküünla normaalne kulumine, mis on otseses seoses sõiduki kasutamise aktiivsusega.

Upozornění: (CZ)

Aplikační tabulka slouží pouze pro výběr svíčky

Zveřejněním tohoto vydání ztrácí dříve vydané aplikační tabulky platnost

Na údaje obsažené v katalogu nelze uplatňovat právní nárok

V tomto vydání nejsou obsaženy doporučení podle směrnice FAA pro letecké pohony

Zapalovací, žhavicí svíčky a svíčkové fajfky uvedené v našem katalogu doporučujeme použít výhradně pro motory uvedené v katalogu. NGK nenese zodpovědnost za rozpoznatelné chyby, jako například tiskové chyby. Za bezchybnost a příslibené vlastnosti ručí NGK v souladu se stávajícím stavem techniky. Základním předpokladem pro toto je odborné zacházení s produkty NGK. Záruka na vady materiálu, či nedostatečný výkon je 24 měsíců od data prodeje, pokud byl dodržen interval výměny předepsaný výrobcem vozidla. Záruka se nevztahuje na vady vzniklé běžným použitím a na jakékoliv užití při sportovních aktivitách.

Uwagi:

PL

Lista zastosowań służy wyłącznie wyborowi typów. Przez publikację niniejszego wydania wszystkie uprzednie listy zastosowań tracą ważność. Treść nie jest podstawą jakichkolwiek roszczeń prawnych. Niniejsze wydanie nie zawiera poleceń dla lotniczych zespołów napędowych według wytycznych FAA.

Nie podlega gwarancji przy normalnym zużyciu lub wykorzystywaniu w sporcie.

Świece zapłonowe, świece żarowe, końcówki przewodów zapłonowych mogą być zastosowane zgodnie z przyporządkowaniem w naszym katalogu. Widoczne pomyłki i błędy w druku podlegają szczególnej uwadze użytkowników. NGK gwarantuje bezbłądność oraz właściwości produktów odpowiadające obecnemu poziomowi techniki. Gwarancja obowiązuje tylko w przypadku prawidłowej eksploatacji produktów NGK. Gwarancja na błędy materiałowe wynosi 24 miesiące od dnia zakupu, jeżeli określone przez producenta pojazdu okresy wymiany nie zostały przekroczone. Wyłączone z tego są: normalne zużycie oraz produkty eksploatowane w sporcie motorowym.

Примечания:

RUS

Данный перечень спецификаций предназначен только для выбора типа свечей.

С опубликованием данного издания все предшествующие перечни спецификаций теряют силу.

Содержание списка не может послужить основой для возникновения правопричитания.

Рекомендации для авиационных двигателей согласно директивам FAA в данное издание не включены.

Свечи зажигания, свечи накаливания и наконечники, приведенные в каталоге, могут быть установлены на конкретные двигатели в соответствии с рекомендациями в каталоге. Видимые ошибки и очевидные опiski подлежат проверки со стороны пользователей. Отсутствие брака и правильность параметров продукции компания NGK гарантирует в соответствии с развитием техники. Гарантия действует только при надлежащей эксплуатации продукции компании NGK. Гарантия на отсутствие заводского брака и на качество используемых материалов действует 24 месяца с момента покупки товара, если иное не предписано производителем автомобиля. Исключение составляет нормальный износ а также использования продукции в гоночных двигателях. Автомобили производителей АвтоВАЗ обозначены VAZ, ГАЗ обозначены GAZ, УАЗ UAZ и Москвич MOSKWICZ. Не используйте для подбора свечей зажигания/накаливания обозначения LADA, VOLGA. Эти обозначения действуют для немецкого рынка.

Megjegyzések:

H

Ez a katalógus csak a típusok kiválasztására szolgál.

Megjelenésével minden korábbi kiadás érvényét veszti.

Tartalma nem ad alapot jogigény benyújtására.

Nem tartalmazza a repülőgépek hajtóművekre vonatkozó FAA szerinti ajánlásokat.

Fentiek alól kivételt képez a természetes elhasználódás, illetve a sportcélú felhasználás esete.

A katalógusunkban felsorolt gyújtógyertyák, izzítógyertyák és gyertyapipák csak a katalógusban ajánlott motorokhoz használhatók. Észlelhető eltérések, úgymint nyomtatási hibák esetén a felhasználó kötelessége körültekintően eljárni. Az NGK garantálja a termék minőségét és az említett jellemzőket a műszaki tudományok jelenlegi állása szerint. Ennek alapvető feltétele az NGK termék megfelelő használata. A garancia anyag-, vagy gyártási hibára vonatkozóan 24 hónap az eladástól számítva, feltételezve a járműgyártó által előírt csereintervallum betartását. A garancia nem érvényes normál elhasználódásra és bármilyen versenyzés esetén.

Σχόλια:**GR**

Αυτός ο κατάλογος εφαρμογών ισχύει μόνο για αναγνώριση τύπου.

Αυτός ο κατάλογος αντικαθιστά όλους τους προηγούμενους καταλόγους.

Δεν φέρουμε καμία ευθύνη σε θέματα εγγυήσεων που αφορούν εφαρμογές που δεν αναφέρονται στον κατάλογο εφαρμογών.

Μπουζί για αεροπορικές εφαρμογές δεν περιέχονται σ' αυτόν τον κατάλογο εφαρμογών.

Τα γπουζί, οι προθερμάνσεις και τα καλύμματα μπουζί που περιέχονται στον κατάλογο μπορούν να χρησιμοποιηθούν στους κινητήρες που προτείνονται στον κατάλογο. Τα αναγνωρίσιμα λάθη, όπως τα λάθη εκτύπωσης πρέπει να απομονώνονται από τον χρήστη. Η NGK παρακολουθεί την ακρίβεια και τα αναφερόμενα χαρακτηριστικά σύμφωνα με τη διαθέσιμη τεχνολογία. Βασική συνθήκη για αυτό είναι η κατάλληλη χρήση του προϊόντος NGK. Η περίοδος εγγύησης για προβλήματα στο υλικό ή για μειωμένη απόδοση είναι 24 μήνες από την ημερομηνία αγοράς, με την προϋπόθεση ότι τηρούνται τα διαστήματα αντικατάστασης που είναι καθορισμένα από τον κατασκευαστή τον οχήματος. Εξαιρούνται από αυτό η φυσιολογική φθορά και οποιαδήποτε μορφή αγωνιστικών δραστηριοτήτων.

Açıklama**TR**

1. Bu liste sadece tiplerin belirlenmesinde kullanılır.
2. Bu baskının yayınlanmasıyla önceden yayınlanan tüm listelerin hükümleri ortadan kalkmış olur.
3. İçerikten dolayı hiçbir yasal hak talep edilemez.
4. Havicılıktan kullanılan motorlarla ilgili FAA'nın talimatları doğrultusundaki tavsiyeler bu baskıda mevcut değildir.

Katalogda belirtilen bujiler, kızdırma bujileri ve bağlantı elemanları katalog tavsiyeleri doğrultusunda motorlarda kullanılabilir. Yanlış anlamalardan ve baskıdan kaynaklanan hatalarda sorumluluk tamamen uygulayıcıya aittir. Ürünün hatasız ve belirtilen özelliklere sahip oluşuyla ilgili olarak NGK, içerisinde bulunan teknolojik gelişmelerin güncelliğine bağlı kalmak kaydıyla, sorumluluk taşır. Bunun geçerliliği için temel koşul NGK ürününün doğru uygulanmış olmasıdır. Malzeme hatası yada hatalı ürün kapsamındaki garanti süresi, otomobil üreticisinin ön gördüğü periyodik değiştirme süresi aşılmadığı taktirde, satınalma tarihinden itibaren 24 aydır.Doğal aşınmaya bağlı eskime ve her türlü modifikasyon uygulaması (Racing, vb.) garanti kapsamının dışındadır.

Redaktionsschluss: 01.08.2006

Redaktion:

Hermann Fink

Tel.: 0 21 02/97 41 27

E-Mail: H.Fink@NGKNTK.de

Änderungen vorbehalten

© = 2006-

Für saubere Luft: Lambdasonden

Seit 1992 unterliegen Pkws einer gesetzlichen Einstufung in Emissionsklassen, den Euro-Normen.

Motorräder hingegen wurden in der politischen und gesellschaftlichen Umweltdiskussion lange vernachlässigt. Durch fehlende gesetzliche Vorgaben blieb ihre umwelttechnische Weiterentwicklung aus: G-Kat und Einspritzanlage suchte man hier meist vergeblich. Dabei sind allein in Deutschland rund fünf Millionen motorisierte Zweiräder zugelassen.

Seit 1999 gibt es Grenzwerte auch für Motorräder. Bis 2006 wurden sie in zwei Stufen weiter abgesenkt. Dies zeigte bei Motorradherstellern Wirkung - technische Entwicklungen zur Emissionssenkung flossen in die Produktion ein. Zukünftig ist mit dem flächendeckenden Einsatz von G-Kats in Motorrädern zu rechnen.

Zudem wird bereits heute ein immer größerer Teil von Motorrädern mit Lambdaregelung ausgestattet. So setzen Hersteller wie etwa BMW, Ducati und Triumph ab Werk Lambdasonden von NGK ein.

NGK leistete bereits in den 90ern Pionierarbeit in der Entwicklung und Herstellung von Lambdasonden für Pkws. Jetzt ist das Unternehmen erneut Vorreiter und ein zuverlässiger Partner für die Motorradhersteller. Immerhin stellt das Motorrad besondere Anforderungen an die Lambdasonde, etwa in puncto Bauform, die so klein wie möglich ausfallen sollte.

Schadstoffe wirkungsvoll reduzieren

Ottomotoren verbrennen ein Gemisch aus Luft und Kraftstoff. Das Abgas aus dieser Verbrennung enthält neben unschädlichen Produkten wie Wasserdampf, Kohlendioxid und Stickstoff auch die Schadstoffe Kohlenmonoxid, Kohlenwasserstoff und Stickoxide.

Sie werden vom Katalysator in unschädliche Gase umgewandelt. Eine optimale Verbrennung und effiziente Umwandlung der Schadstoffe ist jedoch nur gewährleistet, wenn die korrekte Menge Luft und Kraftstoff in den Motor geleitet wird. Bei dieser Aufgabe unterstützt die Lambdasonde die Motorsteuerung, indem sie den Restsauerstoff im Abgas misst - und damit wichtige Informationen liefert.

Abgasuntersuchung für Krafträder (AUK)

Bislang waren Krafträder von der regelmäßigen Untersuchung des Abgas- und Geräuschverhaltens ausgenommen. Mit Stichtag 1. April 2006 ist eine Abgasuntersuchung für zulassungspflichtige Krafträder mit Erstzulassung ab dem 1. Januar 1989 als Bestandteil der Hauptuntersuchung vom Gesetzgeber vorgeschrieben.

Sofern vom Fahrzeughersteller keine Sollwerte bereitgestellt wurden, gelten folgende gesetzlichen Grenzwerte:

- Krafträder ohne geregelte Abgasreinigung
-> CO max. 4,5 Vol.-% im Leerlauf
- Krafträder mit geregelter Abgasreinigung
-> CO max. 0,3 Vol.-% im erhöhten Leerlauf

Weitere Informationen zu Abgasmessung und Messgeräten finden Sie beim Spezialisten Gutmann Messtechnik unter www.gutmann-messtechnik.com



Emissionswerte für Motorräder

	gültig ab	CO (g/km)	HC (g/km)	NOx (g/km)
Euro I	06/1999	13,00	3,00	0,30
Euro II	04/2003	5,50	1,00	0,30
Euro III	01/2006	2,00	0,30	0,15

Funktionsweise der Lambdasonde

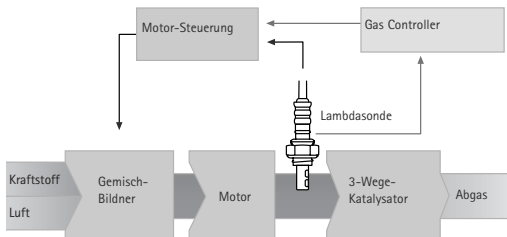

Lambdasondenzuordnung für Motorräder

Hersteller	Modell	Motor	ccm	kW	Baujahr	Order-Nr.	NGK-NTK	Anzahl Kabel	Stecker-Nr.	Länge	Vergleichs-Nr.
Aprilia	RSV 1000 R	Rotax V2	998	102	04.04-	1767	02A591-SZ1	4	31	590mm	A2 C 53025886
Aprilia	RSV 1000 R Factory	Rotax V2	998	102	10.03-	1767	02A591-SZ1	4	31	590mm	A2 C 53025886
BMW	F 650 CS		652	25	11.01-12.03	0427	02A447-E28	4	68	340mm	11781 247 406
BMW	F 650 GS / Dakar		652	37	09.99-12.03	0427	02A447-E28	4	68	340mm	11781 247 406
BMW	F 650 CS	K14/02	652	25 / 37	01.04-12.05	0074	02A630-BM3	4	68	341mm	76 85 320
BMW	F 650 GS	R13Mü	652	25 / 37	12.03-12.06	0074	02A630-BM3	4	68	341mm	76 85 320
BMW	F 800 S	K71	799	25 / 60	12.05-	0073	02A630-BM2	4	99	521mm	76 72 785
BMW	F 800 R	K73	799	25 / 60	12.06-	0073	02A630-BM2	4	99	521mm	76 72 785
BMW	R 850 R	R28	848	25 / 52	07.02-08.05	0053	02A522-BM1	4	69	922mm	76 71 756
BMW	R 850 RT	R22	848	52	03.01-12.04	0053	02A522-BM1	4	69	922mm	76 71 756
BMW	R 1100 S	2595	1085	72	01.03-12.03	0053	02A522-BM1	4	69	922mm	76 71 756
BMW	R 1150 GS / Adventure	R21	1130	63	11.01-12.03	0053	02A522-BM1	4	69	922mm	76 71 756
BMW	R 1150 R	R28	1130	63	10.02-08.05	0053	02A522-BM1	4	69	922mm	76 71 756
BMW	R 1150 RS	R22	1130	70	05.01-	0053	02A522-BM1	4	69	922mm	76 71 756
BMW	R 1150 RT	R22	1130	70	03.01-12.04	0053	02A522-BM1	4	69	922mm	76 71 756
BMW	K 1200 GT	K41GT	1171	72 / 96	11.02-08.05	0053	02A522-BM1	4	69	922mm	76 71 756
BMW	K 1200 GT	K44	1157	112	12.05-	0073	02A630-BM2	4	99	521mm	76 72 785
BMW	K 1200 LT	K589	1171	85	01.04-	0054	02A522-BM2	4	69	554mm	76 71 757
BMW	K 1200 RS	K41	1171	72 / 96	01.01-12.04	0053	02A522-BM1	4	69	922mm	76 71 756
BMW	K 1200 R	K43	1157	120	03.05-	0073	02A630-BM2	4	99	521mm	76 72 785
BMW	K 1200 S	K40	1157	123	06.04-	0073	02A630-BM2	4	99	521mm	76 72 785
BMW	R 1200 C	259C	1170	45	06.03-12.04	0053	02A522-BM1	4	69	922mm	76 71 756
BMW	R 1200 CL	K30	1170	45	02.02-12.04	0053	02A522-BM1	4	69	922mm	76 71 756
BMW	R 1200 GS	K25	1170	72	11.03-	0072	02A630-BM1	4	99	231mm	76 74 452
BMW	R 1200 RT	K26	1170	81	10.04-	0072	02A630-BM1	4	99	231mm	76 74 452
BMW	R 1200 S	K29	1170	81	10.05-	0072	02A630-BM1	4	99	231mm	76 74 452
BMW	R 1200 ST	K28	1170	81	12.04-	0072	02A630-BM1	4	99	231mm	76 74 452
BMW	HP2	K25HP	1170	77	12.05-	0072	02A630-BM1	4	99	231mm	76 74 452
Ducati	Monster 695		695	54	06.04-	0066	02A591-BB3	4	40	880mm	CA.0083 476
Ducati	GI 1000		992	68	01.06-	0066	02A591-BB3	4	40	880mm	CA.0083 476
Ducati	Monster S2R 1000		992	70	01.06-	0066	02A591-BB3	4	40	880mm	CA.0083 476
Ducati	Monster S4RS		992	96	06.04-	0066	02A591-BB3	4	40	880mm	CA.0083 476
Ducati	Paul Smart 1000		992	68	01.06-	0066	02A591-BB3	4	40	880mm	CA.0083 476
Ducati	ST3 / S		992	79	01.04-	0066	02A591-BB3	4	40	880mm	CA.0083 476
Ducati	Sport 1000		992	68	01.06-	0066	02A591-BB3	4	40	880mm	CA.0083 476
Honda	Pantheon 125i		125	10	01.05-	0065	02A577-H6	4	96	280mm	36531-KRU-9010-M1
Honda	PS 125i		125	10	01.06-	0064	02A577-H15	4	96	210mm	36531-KTF-6410-M1
Honda	SH 125i		125	10	01.05-	0064	02A577-H15	4	96	210mm	36531-KTF-6410-M1
Honda	Pantheon 150i		150	12	01.05-	0065	02A577-H6	4	96	280mm	36531-KRU-9010-M1
Honda	SH 150i		150	11	01.05-	0064	02A577-H15	4	96	210mm	36531-KTF-6410-M1
Honda	CBF 1000		998	72 / 75	01.06-	0007	02A577-H17	4	80	990mm	36531-MFAA-D001-M1
KTM	990 Adventure		999	25 / 72	01.06-	0009	02A591-VB2	4	97	500mm	1614 833 0000
KTM	990 Adventure S		999	72	01.06-	0009	02A591-VB2	4	97	500mm	1614 833 0000
KTM	990 Superduke		999	88	01.06-	0009	02A591-VB2	4	97	500mm	1614 833 0000
Moto Guzzi	Breva V 750 i.e.		744	25 / 36	01.03-	0036	02A341-BB1	4	40	310mm	CA.019 265
Moto Guzzi	Breva V 1100		1064	62	03.04-	0036	02A341-BB1	4	40	310mm	CA.019 265
Moto Guzzi	California EV / Touring		1064	55	03.04-12.05	0036	02A341-BB1	4	40	310mm	CA.019 265
Moto Guzzi	California		1064	55	01.06-	0036	02A341-BB1	4	40	310mm	CA.019 265
Moto Guzzi	V11 Cafe Sport		1064	67	03.04-12.04	0036	02A341-BB1	4	40	310mm	CA.019 265
Moto Guzzi	V11 Coppa Italia		1064	67	03.04-12.05	0036	02A341-BB1	4	40	310mm	CA.019 265
Moto Guzzi	V11 Le Mans		1064	67	03.04-	0036	02A341-BB1	4	40	310mm	CA.019 265
Moto Guzzi	Speed Trans Neros		1064	67	03.04-12.05	0036	02A341-BB1	4	40	310mm	CA.019 265
Moto Guzzi	V11 Le Mans Rosso Corsa		1064	67	03.04-12.05	0036	02A341-BB1	4	40	310mm	CA.019 265
Moto Guzzi	V11 Scura R		1064	67	01.05-12.05	0036	02A341-BB1	4	40	310mm	CA.019 265
Moto Guzzi	V11 Sport Ballabio		1064	67	03.04-	0036	02A341-BB1	4	40	310mm	CA.019 265
Suzuki	GSX-R 600		599	91	03.06-	0003	02A448-J4	4	80	690mm	18213-01H00
Suzuki	GSX-R 750		750	110	03.06-	0003	02A448-J4	4	80	690mm	18213-01H00
Suzuki	M 1800 R		1783	92	04.06-	0004	02A448-J5	4	80	370mm	18213-48G00
Triumph	Daytona 600		599	25 / 72	01.03-12.05	0067	02A591-UB1	4	97	640mm	22 01 347
Triumph	Daytona 600		599	82	01.03-12.05	0067	02A591-UB1	4	97	640mm	22 01 347
Triumph	Speed Four		599	25 / 72	01.02-	0067	02A591-UB1	4	97	640mm	22 01 347
Triumph	Thunderbird Sport		855	67	01.03-12.04	0067	02A591-UB1	4	97	640mm	22 01 347
Triumph	Daytona 955i		955	72 / 108	01.01-	0067	02A591-UB1	4	97	640mm	22 01 347
Triumph	Speed Triple		955	72 / 108	01.01-12.05	0067	02A591-UB1	4	97	640mm	22 01 347
Triumph	Sprint RS		955	72 / 108	01.01-12.04	0067	02A591-UB1	4	97	640mm	22 01 347
Triumph	Sprint ST		955	72 / 108	01.01-12.04	0067	02A591-UB1	4	97	640mm	22 01 347
Triumph	Tiger		955	72	01.03-	0067	02A591-UB1	4	97	640mm	22 01 347
Triumph	Tiger		955	78	01.04-	0067	02A591-UB1	4	97	640mm	22 01 347
Triumph	Sprint ST		1050	72 / 92	01.05-	0067	02A591-UB1	4	97	640mm	22 01 347
Triumph	Speed Triple		1050	72	01.06-	0067	02A591-UB1	4	97	640mm	22 01 347
Triumph	Speed Triple		1050	95	01.05-	0067	02A591-UB1	4	97	640mm	22 01 347
Triumph	Rocket III		2294	104	01.04-12.04	0008	02A591-UB2	4	97	535mm	22 01 247
Triumph	Rocket III		2294	72 / 103	01.05-	0008	02A591-UB2	4	97	535mm	22 01 247
Triumph	Rocket III Classic		2294	72 / 103	01.06-	0008	02A591-UB2	4	97	535mm	22 01 247

NGK Verbindungsstecker



No. 31
OZA591-YB1



No. 80
OZA448-J4
OZA448-J5
OZA577-H17



No. 33
OZA222-S02



No. 96 neu
OZA577-H15
OZA577-H6



No. 40
OZA334-BB1
OZA341-BB1
OZA591-BB3



NEU
No. 97
OZA591-UB1
OZA591-UB2
OZA591-VB2



No. 68
OZA630-BM3



NEU
No. 98
OZA591-WB1



No. 69
OZA532-BM1
OZA532-BM2

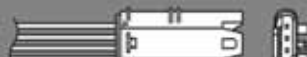

NEU
No. 99
OZA630-BM1
OZA630-BM2



Delivering Innovations
for 70 years



2006 **NGK**
Racing spark plugs



2006 **NGK** Motor Sports
2006 **NGK** Support Team



■ Motorcycles

MotoGP

Camel Yamaha Team
JIR Konica Minolta Honda
Tech 3 Yamaha
Team Roberts
Ducati Team
Kawasaki Racing Team
Rizla Suzuki MotoGP
Fortuna Honda
Repsol Honda Team

**World Motocross
Championship**

Team Suzuki World MXGP
Kawasaki Racing

AMA Supercross

Team Makita Suzuki
Kawasaki Motocross Racing

**FIM World Superbike
Championship**

Team Alstare Suzuki Corona Extra
Ducati Xerox Team



Cars

Formula 1 Championship

McLaren Mercedes
Scuderia Ferrari
Honda Racing F1 Team
BMW Sauber F1 Team
SUPER AGURI FORMULA 1

World Touring Car Championship

BMW Team Deutschland

Paris - Dakar Rally

Team Repsol Mitsubishi Ralliart

Super GT

NISMO
Team Honda Racing
Team IMPUL
Nakajima Racing
HASEMI MOTORSPORT
Team KUNIMITSU



Series of **NGK** racing spark plugs

Blue colour indicates resistor plugs

Thread size (Hexagon size)	Spark plug type	Spark plug number	Heat rating	Firing end appearance	Electrode material			
					Center	Ground		
φ14×19mm(20.8mm)	BP-E	R4304A-	7,8,9,10	Ⓐ ①	Gold Palladium	Nickel Alloy		
		R6918B-	7,8,9	Ⓐ ①	Platinum	Nickel Alloy		
		R6918C-	9	Ⓐ ①	Platinum	Nickel Alloy		
		R6021E-	8,9,10,10,5	Ⓐ ①	Nickel Alloy	Nickel Alloy		
		R6061-	7,8,9,10,11	Ⓐ ①	Nickel Alloy	Nickel Alloy		
	B-E	R6252E-	9,10,5	Gap0.6	Ⓒ ①	Nickel Alloy	Nickel Alloy	
		R6252K-	10,5	Gap0.8	Ⓒ ①	Nickel Alloy	Nickel Alloy	
		R6254E-	9,10,5	Gap0.6	Ⓒ ①	Nickel Alloy	Nickel Alloy	
		R6254K-	10,5	Gap0.8	Ⓒ ①	Nickel Alloy	Nickel Alloy	
		R7376-	7,8,9,10		Ⓒ ①	Iridium	Platinum	
φ14×22mm(20.8mm)	Semi surface discharge	R5649-	9,10,11	Ⓐ ①	Nickel Alloy	—		
		R6712-	9,10	Ⓐ ①	Nickel Alloy	—		
	Short	R8179A- P	10,5,11		Ⓒ ②	Platinum	Platinum	
		R6179C- PA	10,5		Ⓒ ②	Platinum	Platinum	
	φ14×22mm(16.0mm)	Short	R7282A-	10,10,5,11	Ⓒ ②	Iridium	Platinum	
			R7282-	7,8,9,10,10,5,11	Ⓒ ②	Iridium	Platinum	
	φ14×19mm(16.0mm)	Short	R7282C-	11	No gasket type Ⓒ ②	Iridium	Platinum	
			R7282M-	11,11,5	Ⓒ ②	Iridium	Platinum	
			R6888A-	8,9,10	Ⓒ ②	Nickel Alloy	Nickel Alloy	
			R7433-	8,9,10	Ⓐ ②	Iridium	Nickel Alloy	
φ14×19mm(16.0mm)	BK-E(ISO)※1	R7434-	8,9,10	Ⓒ ②	Iridium	Platinum		
		R7279-	10	Ⓒ ②	Iridium	Platinum		
	BC-E(ISO)※1	Semi surface discharge	R6601-	8,9,10,11	Ⓒ ②	Nickel Alloy	—	
		Semi surface discharge	R6711-	9,10	Ⓒ ②	Nickel Alloy	—	
	BCP-E(JIS)	R7435-	8,9,10		Ⓐ ②	Iridium	Nickel Alloy	
		R7436-	8,9,10		Ⓒ ②	Iridium	Platinum	
	BC-E(JIS)	Semi surface discharge	R5883-	9,10,11	Ⓒ ②	Nickel Alloy	—	
		Semi surface discharge	R6690-	9,10,11	Ⓒ ②	Nickel Alloy	—	
	φ14×26.5mm(16.0mm)	LFR	Extra long reach	R7437-	8,9,10	Ⓐ ②	Iridium	Nickel Alloy
			Extra long reach	R7438-	8,9,10	Ⓒ ②	Iridium	Platinum
φ14×12.7mm(20.8mm)	B-H	R5525-	7,8,9,10,11	Ⓑ ②	Gold Palladium	Nickel Alloy		
		R5530-	8,9,10,11	Ⓐ ②	Gold Palladium	Platinum		
φ14×21.5mm(20.8mm)	Rotary Engine RX-7	R6725-	9,10,10,5,11,11,5	Ⓐ ②	Platinum	Platinum		
		R7420-	9,10,10,5,11	Ⓐ ②	Iridium	Platinum		
φ14×21mm(20.8mm)	Rotary Engine RX-8 L	R7440A-	L 9,10	Ⓒ ②	Iridium	Platinum		
		φ14×19mm(20.8mm)	Rotary Engine RX-8 T	R7440B-	T 10,11	Ⓒ ②	Iridium	Platinum
φ12×19mm(16.0mm)	DC-E			Semi surface discharge	R2349-	9,10,11	Ⓒ ②	Nickel Alloy
		R2525-	9,10,11	Ⓒ ②	Platinum	Nickel Alloy		
		R0373A-	9,10	Ⓒ ②	Iridium	Platinum		
φ10×19mm(16.0mm)	C-E	Semi surface discharge	R0045G-	10,11	GAP1.4	Ⓒ ②	Nickel Alloy	—
		Semi surface discharge	R0045J-	9,10,11,12	GAP1.1	Ⓒ ②	Nickel Alloy	—
		Semi surface discharge	R0045Q-	10,11	GAP1.1	Ⓒ ②	Nickel Alloy	—
φ10×19mm Half thread (16.0mm)	C-EH	*R0379A-	10	Ⓒ ②	Iridium	Platinum		
		R0409B-	8,9,10	Ⓒ ②	Iridium	Nickel Alloy		
φ10×12.7mm(16.0mm)	C-H	R0161-	9,10,11	Ⓑ ②	Nickel Alloy	Nickel Alloy		
		φ8X19mm(13.0mm)	E-EH	Semi surface discharge	R847-	10,11	Ⓒ ②	Nickel Alloy

1) ISO The length from gasket to terminal of ISO type spark plugs is 50.5mm which is 2.5mm shorter than BCP-E or BC-E type spark plugs.

2) Resistor spark plugs are recommended for cars originally equipped with resistor spark plugs. When nonresistor spark plugs are installed in such cars, there is some possibility that the electric devices in the car, such as the audio system or the engine management system, would be affected by noise.

3) Marked * part number will be discontinued when the current stock is over.

■ Appearance

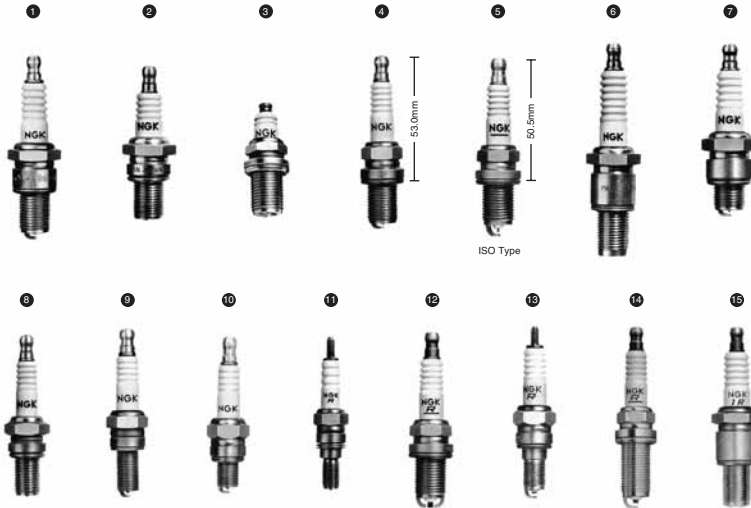

■ Firing end



■ Discontinued plug types

Blue colour indicates resistor plugs.

Old part number		New part number	Old part number		New part number
R016 - R017	→	R0373A	R5400 - R5400F - R6337	→	R7435
R216 - R217	→	R2525 -	R5686	→	R7435
R2270 - R2430	→	R2349 -	R5830 - R5687	→	R7436
R4630A - R6385 - P	→	R7376 -	R7112 - R7113	→	R7433
R6120	→	R7282 -	R7114 - R7115	→	R7433
R6120A	→	R7282A	R7116 - R7117	→	R7434
R6120C	→	R7282C	R7118 - R7119	→	R7434
R6120M	→	R7282M	R7232 - R7233	→	R7435
R6255 - R6255F - R6326	→	R7433 -	R7234 - R7235	→	R7435
R6205 - R6241	→	R7433 -	R7236 - R7237	→	R7436
R6206 - R6242	→	R7434 -	R7238 - R7239	→	R7436

Recommendation chart of NGK racing spark plugs for motorcycles

Manufacturer	Model	Spark plug Number	Racing spark plug IX, VX spark plug
HONDA			
Road race			
CB1000SF/CB1300SF	DPR8E-9	R2525-	
CB400 SuperFour	CR8EH-9	CR8EHX-9, R0409B-	
CB400SS	DPR8E	R2525-	
CBR1000RR	IMR9C-9HES	R0409B-9, R0045Q-	
CBR1100XX	IMR9C-9H	R0409B-9, R0045Q-	
CBR400RR	CR8EH-9	CR8EHX-9, R0409B-	
CBR600F/FS/4/RR	IMR9C-9HES	R0409B-9, R0045Q-	
CBR900RR/CBR954RR	IMR9C-9H	R0409B-9, R0045Q-	
NS-1/NSR50	BR9EG	BR9EIX/R0378-	
NSR250R/SE/RSP	BR9ECM	BR10EIMX	
RVF/RC45	CR9EHX-9	R0409B-9, R0045Q-	
VTR1000F	DPR8EVX-9	R2525-	
VTR1000SP/II	IFR9H11	R7279-10	
RS125R	R8385-10SP	R7379-10, R7282A-10SP-1	
RS250R	R8120-10S	R7282-10S, R7282A-10S-1	
XR400Motard	CR8EH-9	CR8EHX-9, R0409B-	
XR400Motard	DPR8Z	DPR8ZX	
Motocross			
CR125R	BR9EG	BR9EIX/R3736-9	
CR250R	BR9EG	BR8EIX/R3736-8	
CR80R/R2	B10EG	BR10EIX/R3736-	
CR65R/R4	BR10EG	BR10EIX/R3736-	
CRF100F	CR7HSA	CR7HX	
CRF250R	R0409B-8	R0409B-8	
CRF450R	IFR9H11	R7433-8	
CRF50F/CRF70F	CR6HSA	CR6HX	
QR50	BFR4HS	-	
XR250R	CR9EH-9	CR8EHX-9, R0409B-9	
XR50R/R370R	CR6HSA	CR6HX	
RTL250R	BR9ES	R7378-	
RTL250F	CR8EH-9	-	
TLM200R	B8ES	BR8EIX	
TLM220R	BR8ES	BR8EIX	
TLM260R	B6ES	B6EYX	
TLR250R	D8EA	DR8EIX	
TLR260	BR9ES	-	
YAMAHA			
Road race			
FZ400	D8EA	R2525-	
RZ50 5FC	BR8ES	BR8EIX, R3736-	
SR400/SF500	BPR6ES	BPR- EIX, R3736-	
SRV250	CR7HSA	CR- HX	
TDM850/TRX350	DPR8EA-9	R2525-	
TD90W/T90W/T90SP	BR8ES	BR- EIX, R3736-	
TZR250SPR/5/5R	BR9ECM	BR10EIMX	
XJR1200R/XJR1300	DPR8EA-9	R2525-	
XJR400R/RII	CR9E	R0373A-9, R0045Q-	
YZF1000R/R1	DR8EA	R2525-	
YZF750P	CR9E	R0373A-9, R0045Q-	
YZF-R1	CR9EK	R0373A-9, R0045Q-	
YZF-R6	CR10EK	R0373A-9, R0045Q-	
YZF-R7	R028ER-10	R0373A-9, R0045Q-	
TZ125	R8385-10SP	R7376-10, R7376B-10SP-1	
TZ250	R8179A-10SP	R8179A-10SP/R8179C-10SP/8-1	
Off road			
TY250Z	CR9E	CR9EIX	
TY250Z/ZS	BPR6E	BPR6EIX	
XT250W/WE	DR8EA	DR8EIX	
Motocross			
PW50	BFR4HS	-	
WR250F/WR400F/WR450F	CR9E	CR9EIX	
YZ125	BR9EYX	BR9EIX, R3736-9	
YZ250	BR9EG	BR8EIX, R3736-8	
YZ250F/YZ260F/YZ450F	CR9E	CR9EIX	
YZ60/LW/YZ85/LW	BR10EG	BR10EIX, R3736-	
Trial			
TY250Z	BPR6E	BPR6EIX	

Manufacturer	Model	Spark plug Number	Racing spark plug IX, VX spark plug
KAWASAKI			
Road race			
0-TRACKER	CR8E	R0373A-9, R0045Q-	
GP2100ABS	CR9EK	R0373A-9, R0045Q-	
GPZ200R	DR8EA	R2525-	
Z-1	B8ES	BR- EIX, R3736-	
ZEPHYR1100/RS	CR9E	R0373A-9, R0045Q-	
ZRX1100M/ZRX1200R/S	CR9EK	R0373A-9, R0045Q-	
ZX-10R	CR8EA-9	-	
ZX-12R	CR9ECPA	R0373A-9, R0045Q-	
ZX-6RR/ZX-7RR	CR9E	R0373A-9, R0045Q-	
ZX-9R/ZXR400R	CR9EK	R0373A-9, R0045Q-	
ZZ-1100	CR9E	R0373A-9, R0045Q-	
Off road			
KLX250(1986.2~)	CR8E	CR8EIX/R0373A-	
KLX125(-2003)	BR9EIX	R3736-9	
Motocross			
KX125(2004-2005)	R8918B-9	R8918B-9/R3736-9	
KX125(2006~)	BR9ECMVX	BR9ECMVX	
KX250(-2004)	BR9EK	R3736-9	
KX250(2005~)	BR9ECMVX	BR9ECMVX	
KX250F(2004-2005)	CR8EB	CR8EBx2	
KX250F(2006~)	CR8E	CR8EIX	
KX450F	CPR8EB-9	-	
KX65	B10EG	BR10EIX/R3736-	
KX811	R0252K-10S	-	
SUZUKI			
Road race			
GS1200SG/SGF1200	JR8B	R2525-	
GSX1300R	CR9E	R0373A-9, R0045Q-	
GSX-R1100W/GSX-R1000	CR9E	R0373A-9, R0045Q-	
GSX-R600GSX-R750R/600	CR9E	R0373A-9, R0045Q-	
GSX-R125(1991-11~)	BR9ECM	BR9ECMVX	
RGV-T250R(1990.2~)	BR9ECM	BR10EIMX	
SGX1100T	DR8EA	R2525-	
TL1000R	CR8EK	R0373A-9, R0045Q-	
TL1000S	CR8E	R0373A-9, R0045Q-	
Motocross			
RM125	R8918B-8	-	
RM250	R8918B-7	-	
RM60R/PM85	BR10EIX	BR10EIX/R3736-	
RM-Z250	CR8EB	CR8EBx2	
RM-Z450	CR8EB	CR8EBx10	
BIMOTA			
Road race			
S86R	CR9E	R0373A-9, R0045Q-	
BMW			
Road race			
R1100S	BKR7EKC	R7434-	
DUCATI			
Road race			
748R/RS	DR9REIX	R2525-	
749S	CR9EVX	R0373A-9, R0045Q-	
916SP/SPS/996SPS	R2349-10	-	
GAS-GAS			
Trial			
TXT250	BPR6ES	BPR6EIX	
TXT280	BPR6ES	BPR6EIX	
KTM			
Motocross			
125SX/200SX	BR9EVX	BR9EIX, R3736-9	
250SX	BR9ECM	BR9ECMVX	
450SX-R	DCPR8E	R2525-	
50SX	BR9ECM	BR9ECMVX	
525SX	DCPR8E	R2525-	
65SX/85SX	R7234-10	R7435-10	
LAVERDA			
Road race			
750S Formula	DCR8EIX	R2525-	
MONTESA			
Trial			
COTA315	BR6ES	-	

①: The thread length is longer than the normal type due to setting the detonation counter.
②: You need terminal nut.

Choosing a racing plug

■ Choose the right spark plug for your engine based on heat range and electrode design, engine tuning, and racing conditions.

■ Heat range

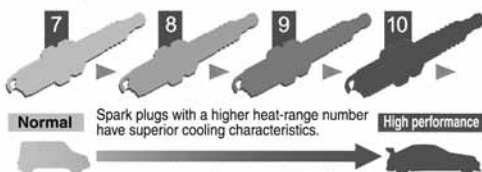

Racing plugs for both two- and four-wheel vehicles have been developed and designed for use in engines that have been fine-tuned to achieve maximum power under specific racing conditions. Racing plugs differ from standard plugs, both in appearance and performance, and often sacrifice plug life, and efficiency at low-speeds for optimum performance and durability under torturous racing conditions.

■ Electrode design

- Engine tuning
- Torturous racing conditions
- Avoid problems due to extremes of temperature

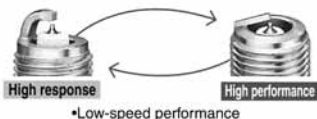

■ What to look for when choosing a racing plug

Point 1

Shell design – To determine what kind of shell design fits in your engine, check the serial number of regulation plugs or the plugs you are currently using to verify the thread diameter, pitch, thread length and shell seat.

Point 2

Firing End design – Refer to the section below on electrode design to determine which type is best for your needs.

Point 3

Heat range – It's important to choose a racing plug with a heat range that keeps the electrode at an optimum temperature under even the most torturous racing conditions. And remember: A higher heat-range number does not improve engine performance, it increases the plug's ability to dissipate heat.

Point 4

Resistors – Due to advances in ignition-system technology, there is little if any difference in performance between plugs with resistors and those without. However there are still some variations of some models that require plugs with resistors to avoid engine trouble.

■ Choosing a firing end design

Although a good rule of thumb is that the more an electrode projects into the cylinder, the better ignition it provides, it's also true that longer projections are more susceptible to the wear and tear of extreme temperatures. High-power, high-performance engines, of course, not only run hotter, they also vibrate more, which is why we recommend choosing a firing end design that reduces exposure of the electrode and insulator as much as possible.

Projected type



Quite similar to a standard spark plug electrode, these plugs give good overall performance in lightly tuned and naturally aspirated engines, as well as good performance in the low to medium torque range in turbo engines.

Angled ground strap type



These provide superior performance in turbocharged engines with power boosts of 50% or more. The short ground electrode is also highly durable against mechanical shock.

Semi-surface discharge



In a sense, this is the ultimate plug configuration. Nearly all insulator cracking and electrode melting can be prevented with this type. Nevertheless, service life and low-speed performance may suffer slightly.

Once you've found a plug that matches your needs, give it a try and feel the exhilaration of getting 120% performance from your engine.

INSTALLATION

To install spark plugs in the engine, first tighten them by fingers, then retighten with the right tightening torques as shown below, using a plug wrench.

Either excessive tightness or looseness will cause troubles. Looseness sometimes causes pre-ignition because heat cannot disperse. On the other hand, excessive tightness can damage the threads of both the cylinder head and the spark plug.

■ Tightening angles



Thread size	New gasket	Used gasket
φ14mm (except※)	$\frac{2}{3}$ of a turn(240°)	$\frac{1}{12}$ of a turn(30°)
φ12mm φ10mm	$\frac{1}{2}$ of a turn(180°)	$\frac{1}{12}$ of a turn(30°)
φ8mm	$\frac{1}{3}$ of a turn(120°)	$\frac{1}{12}$ of a turn(30°)
※ R6469-9 R6918C-9	$\frac{1}{3}$ of a turn(120°)	$\frac{1}{12}$ of a turn(30°)



■ Tightening torques

Spark plug type (thread diameter)	Aluminium cylinder head
Flat seat type (with gasket)	φ14mm 25~30N·m (2.5~3.0kg·m 18.0~21.6 lb·ft)
	φ12mm 15~20N·m (1.5~2.0kg·m 10.8~14.5 lb·ft)
	φ10mm 10~12N·m (1.0~1.2kg·m 7.2~8.7 lb·ft)
	φ 8mm 8~10N·m (0.8~1.0kg·m 5.8~7.2 lb·ft)

■ NGK Spark plug covers for racing spark plugs

Plug cover number (Colour)	Applicable plug type and cable
TRS1225 (Blue) *For Honda Racer only	R7282-  , R7282A-  , R7282C-  , R7282M-  φ8mm cable
TRS1233A (Red) TRS1233B (Yellow) TRS1233C (Green)	R7282-  , R7282A-  , R7282C-  , R7282M-  φ7mm cable
TRS1408F (Blue)	R5300A-  , R5300N-  φ8mm cable
TRS1409 (Red)	R5540F-  φ7mm cable

Standard 			IRIDIUM IX 		
Standard-type	IX Typen	Order No.	Standard-type	IX Typen	Order No.
B6HS	BR6HIX	3419	C8EH-9	CR8EHIX-9	3797
B7HS	BR7HIX	7067	C8HSA	CR8HIX	7669
B8ES	BR8EIX	5044	C9E	CR9EIX	3521
B8HS	BR8HIX	7001	C9EH-9	CR9EHIX-9	6216
B9ES	BR9EIX	3981	CR5HSA	CR5HIX	7120
B10ES	BR10EIX	6801	CR5HSB	CR5HIX	7120
BP5ES	BPR5EIX	6597	CR6HS	CR6HIX	7274
BP6ES	BPR6EIX	6637	CR6HSA	CR6HIX	7274
BP6HS	BPR6HIX	4085	CR7E	CR7EIX	7385
BP6HSA	BPR6HIX	4085	CR7HS	CR7HIX	7544
BP7ES	BPR7EIX	4055	CR7HSA	CR7HIX	7544
BP7HS	BPR7HIX	5944	CR8E	CR8EIX	4218
BP8HS	BPR8HIX	6742	CR8EB	CR8EIX	4218
BP8HSA	BPR8HIX	6742	CR8EH-9	CR8EHIX-9	3797
BPR5ES	BPR5EIX	6597	CR8HS	CR8HIX	7669
BPR6ES	BPR6EIX	6637	CR8HSA	CR8HIX	7669
BPR6HS	BPR6HIX	4085	CR9E	CR9EIX	3521
BPR6HSA	BPR6HIX	4085	CR9EB	CR9EIX	3521
BPR7ES	BPR7EIX	4055	CR9EH-9	CR9EHIX-9	6216
BPR7HS	BPR7HIX	5944	D8EA	DR8EIX	6681
BPR8HS	BPR8HIX	6742	D9EA	DR9EIX	4772
BPR8HSA	BPR8HIX	6742	DP7EA-9	DPR7EIX-9	7803
BR6HS	BR6HIX	3419	DP8EA-9	DPR8EIX-9	2202
BR6HSA	BR6HIX	3419	DP9EA-9	DPR9EIX-9	5545
BR7HS	BR7HIX	7067	DPR7EA-9	DPR7EIX-9	7803
BR8ES	BR8EIX	5044	DPR8EA-9	DPR8EIX-9	2202
BR8HS	BR8HIX	7001	DPR9EA-9	DPR9EIX-9	5545
BR8HSA	BR8HIX	7001	DR8EA	DR8EIX	6681
BR9ES	BR9EIX	3981	DR8EB	DR8EIX	6681
C5HSA	CR5HIX	7120	DR8ES	DR8EIX	6681
C5HSB	CR5HIX	7120	DR8ES-L	DR8EIX	6681
C6HSA	CR6HIX	7274	DR9EA	DR9EIX	4772
C7E	CR7EIX	7385			
C7HSA	CR7HIX	7544			
C8E	CR8EIX	4218			

IRIDIUM IX 			Standard 	
IX Typen	Gewinde	Order No.	Verwendbar für	
BPR5EIX	14 mm	6597	BP5ES, BPR5ES	
BPR6EIX	14 mm	6637	BP6ES, BPR6ES	
BPR6HIX	14 mm	4085	BP6HS, BP6HSA, BPR6HS, BPR6HSA	
BPR7EIX	14 mm	4055	BP7ES, BPR7ES	
BPR7HIX	14 mm	5944	BP7HS, BPR7HS	
BPR8HIX	14 mm	6742	BP8HS, BP8HSA BPR8HS, BPR8HSA	
BR6HIX	14 mm	3419	B6HS, BR6HS, BR6HSA	
BR7HIX	14 mm	7067	B7HS, BR7HS	
BR8EIX	14 mm	5044	B8ES, BR8ES	
BR8HIX	14 mm	7001	B8HS, BR8HS, BR8HSA	
BR9EIX	14 mm	3981	B9ES, BR9ES	
BR10EIX	14 mm	6801	B10ES	
CR5HIX	10 mm	7120	C5HSA, C5HSB, CR5HSA, CR5HSB	
CR6HIX	10 mm	7274	C6HSA, CR6HS, CR6HSA	
CR7EIX	10 mm	7385	C7E, CR7E	
CR7HIX	10 mm	7544	C7HSA, CR7HS, CR7HSA	
CR8EHIX-9	10 mm	3797	C8EH-9, CR8EH-9	
CR8EIX	10 mm	4218	C8E, CR8E, CR8EB	
CR8HIX	10 mm	7669	C8HSA, CR8HS, CR8HSA	
CR9EHIX-9	10 mm	6216	C9EH-9, CR9EH-9	
CR9EIX	10 mm	3521	C9E, CR9E, CR9EB	
DPR7EIX-9	12 mm	7803	DP7EA-9, DPR7EA-9	
DPR8EIX-9	12 mm	2202	DP8EA-9, DPR8EA-9	
DPR9EIX-9	12 mm	5545	DP9EA-9, DPR9EA-9	
DR8EIX	12 mm	6681	D8EA, DR8EA, DR8EB, DR8ES, DR8ES-L	
DR9EIX	12 mm	4772	D9EA, DR9EA	



Order No.



Gold-Palladium



Platin

Order No.

Quick-No.

Iridium



Order No.

ACCOSSATO

Enduro Unitrac	50	03.74 -	B6ES	7310	0,7	B6EVX	5136			
CR 80 Cross/Enduro	80				0,5	B9EGV	5827			

ADLER

Junior MR 100	100		B8HS	5510	0,5	B8HVX	2634	205	BR8HIX	7001
M 100	100		B8HS	5510	0,5	B8HVX	2634	205	BR8HIX	7001
M 125	125		B8HS	5510	0,5	B8HVX	2634	205	BR8HIX	7001
MB 150	150		B8HS	5510	0,5	B8HVX	2634	205	BR8HIX	7001
MB 200	200		B7HS	5110	0,5	B7HVX	7836	204	BR7HIX	7067
MB 201	200		B7HS	5110	0,5	B7HVX	7836	204	BR7HIX	7067
MB 250	250		B7HS	5110	0,5	B7HVX	7836	204	BR7HIX	7067
MB 250 Favorit	250		B8HS	5510	0,5	B8HVX	2634	205	BR8HIX	7001

AJP







Enduro 125	125	03 -	DR8ES	5423	0,8	DR8EVX	6354	217	DR8EIX	6681
Super-Moto 125	125	03 -	DR8ES	5423	0,8	DR8EVX	6354	217	DR8EIX	6681
Enduro 200	200	03 -	DR8ES	5423	0,8	DR8EVX	6354	217	DR8EIX	6681
Super-Moto 200	200	03 -	DR8ES	5423	0,8	DR8EVX	6354	217	DR8EIX	6681
P 250 Cross	250	04 -	CR8EB	7784	0,6	CR8EVX	6487		CR8EIX	4218

ALFER

GR 30, TX 30	50		BR8HS	4322	0,6	BR8HVX	6265	212	BR8HIX	7001
MC 80	80				0,5	B9EGV	5827			
GR125 ISDE	125				0,5	B8EGV	5627			
MC 125	125				0,5	B9EGV	5827			
VRE 125 (4T)	125		CR9E	6263	0,7	CR9EVX	5943	227	CR9EIX	3521
VRE 125 no limit (4T)	125		CR9E	6263	0,7	CR9EVX	5943	227	CR9EIX	3521
EGR 250 Agua / Air	250		B8ES	2411	0,5	B8EGV	5627	201	BR8EIX	5044
MC 250	250				0,5	B9EGV	5827			
VR 250 (2T)	250		BR8ES	5422	0,8	BR8EVX	1262	207	BR8EIX	5044
VR 250 no limit Supermoto (2T)	250		BR8ES	5422	0,8	BR8EVX	1262	207	BR8EIX	5044
AR-1	300		B8ES	2411	0,5	B8EVX	7051	201	BR8EIX	5044
GR 300 Agua	300		B8ES	2411	0,5	B8EGV	5627	201	BR8EIX	5044
TX-300	300		B8ES	2411	0,5	B8EGV	5627	201	BR8EIX	5044
MC 500	490				0,5	B9EGV	5827			

AMERICAN IRON HORSE

Bandit ST	1573	99 - 02	BPR5ES-11	3524	1,0	BCPR5EVX-11	2372		BCPR5EIX-11	3306
Classic SX	1573	99 - 02	BPR5ES-11	3524	1,0	BCPR5EVX-11	2372		BCPR5EIX-11	3306
Legend SC	1573	99 - 02	BPR5ES-11	3524	1,0	BCPR5EVX-11	2372		BCPR5EIX-11	3306
Outlaw SY	1573	99 - 02	BPR5ES-11	3524	1,0	BCPR5EVX-11	2372		BCPR5EIX-11	3306
Slammer SZ	1573	99 - 02	BPR5ES-11	3524	1,0	BCPR5EVX-11	2372		BCPR5EIX-11	3306
Stalker SR	1573	99 - 02	BPR5ES-11	3524	1,0	BCPR5EVX-11	2372		BCPR5EIX-11	3306
Thunder SW	1573	99 - 02	BPR5ES-11	3524	1,0	BCPR5EVX-11	2372		BCPR5EIX-11	3306
Bandit ST	1753	99 - 03	BPR5ES-11	3524	1,0	BCPR5EVX-11	2372		BCPR5EIX-11	3306
Classic SX	1753	99 - 03	BPR5ES-11	3524	1,0	BCPR5EVX-11	2372		BCPR5EIX-11	3306
Legend SC	1753	99 - 03	BPR5ES-11	3524	1,0	BCPR5EVX-11	2372		BCPR5EIX-11	3306
Outlaw SY	1753	99 - 03	BPR5ES-11	3524	1,0	BCPR5EVX-11	2372		BCPR5EIX-11	3306
Slammer SZ	1753	99 - 03	BPR5ES-11	3524	1,0	BCPR5EVX-11	2372		BCPR5EIX-11	3306
Stalker SR	1753	99 - 03	BPR5ES-11	3524	1,0	BCPR5EVX-11	2372		BCPR5EIX-11	3306
Thunder SW	1753	99 - 03	BPR5ES-11	3524	1,0	BCPR5EVX-11	2372		BCPR5EIX-11	3306
Legend SC	1819	04 -	DCPR7E	3932	1,0	DCPR7EVX	1179		DCPR7EIX	6046

					Order No.		Gold-Palladium	Platin 	Order No.	Quick-No.	Iridium 	Order No.
AMERICAN IRON HORSE												
LSC	1819	04 -	DCPR7E	3932	1,0		DCPR7EVX	1179			DCPR7EIX	6046
Outlaw SY	1819	04 -	DCPR7E	3932	1,0		DCPR7EVX	1179			DCPR7EIX	6046
Slammer SZ	1819	04 -	DCPR7E	3932	1,0		DCPR7EVX	1179			DCPR7EIX	6046
Stalker SR	1819	04 -	DCPR7E	3932	1,0		DCPR7EVX	1179			DCPR7EIX	6046
Tejas SJ	1819	04 -	DCPR7E	3932	1,0		DCPR7EVX	1179			DCPR7EIX	6046
Texas Chopper SX	1819	04 -	DCPR7E	3932	1,0		DCPR7EVX	1179			DCPR7EIX	6046
Bandit ST	1852	99 - 03	BPR5ES-11	3524	1,0		BCPR5EVX-11	2372			BCPR5EIX-11	3306
Classic SX	1852	99 - 03	BPR5ES-11	3524	1,0		BCPR5EVX-11	2372			BCPR5EIX-11	3306
Legend SC	1852	99 - 03	BPR5ES-11	3524	1,0		BCPR5EVX-11	2372			BCPR5EIX-11	3306
Outlaw SY	1852	99 - 03	BPR5ES-11	3524	1,0		BCPR5EVX-11	2372			BCPR5EIX-11	3306
Slammer SZ	1852	99 - 03	BPR5ES-11	3524	1,0		BCPR5EVX-11	2372			BCPR5EIX-11	3306
Stalker SR	1852	99 - 03	BPR5ES-11	3524	1,0		BCPR5EVX-11	2372			BCPR5EIX-11	3306
Thunder SW	1852	99 - 03	BPR5ES-11	3524	1,0		BCPR5EVX-11	2372			BCPR5EIX-11	3306
Legend SC	1918	04 -	DCPR7E	3932	1,0		DCPR7EVX	1179			DCPR7EIX	6046
Outlaw SY	1918	04 -	DCPR7E	3932	1,0		DCPR7EVX	1179			DCPR7EIX	6046
Slammer SZ	1918	04 -	DCPR7E	3932	1,0		DCPR7EVX	1179			DCPR7EIX	6046
Stalker SR	1918	04 -	DCPR7E	3932	1,0		DCPR7EVX	1179			DCPR7EIX	6046
Tejas SJ	1918	04 -	DCPR7E	3932	1,0		DCPR7EVX	1179			DCPR7EIX	6046
Texas Chopper SX	1918	04 -	DCPR7E	3932	1,0		DCPR7EVX	1179			DCPR7EIX	6046
Legend SC	2033	03 - 04	DCPR7E	3932	1,0		DCPR7EVX	1179			DCPR7EIX	6046
Outlaw SY	2033	03 - 04	DCPR7E	3932	1,0		DCPR7EVX	1179			DCPR7EIX	6046
Ranger T SG	2033	03 -	DCPR7E	3932	1,0		DCPR7EVX	1179			DCPR7EIX	6046
Slammer SZ	2033	03 - 04	DCPR7E	3932	1,0		DCPR7EVX	1179			DCPR7EIX	6046
Stalker SR	2033	03 - 04	DCPR7E	3932	1,0		DCPR7EVX	1179			DCPR7EIX	6046
Tejas SJ	2033	03 - 04	DCPR7E	3932	1,0		DCPR7EVX	1179			DCPR7EIX	6046
Texas Chopper SX	2033	03 - 04	DCPR7E	3932	1,0		DCPR7EVX	1179			DCPR7EIX	6046
APRILIA												
AF1 50	50	01.86 -	B9ES	2611	0,5		B9EVX	7254	202		BR9EIX	3981
Classic 50 (GI)	50	99 -	BR8ES	5422	0,8		BR8EVX	1262	207		BR8EIX	5044
ET 50 AE,-Fire	50	01.87 -	B9ES	2611	0,5		B9EVX	7254	202		BR9EIX	3981
GL 50	50	02.93 -	B9ES	2611	0,5		B9EVX	7254	202		BR9EIX	3981
LX 50	50	02.93 -	B9ES	2611	0,5		B9EVX	7254	202		BR9EIX	3981
MX 50 (RX50) (ST)	50	03 -	BR8ES	5422	0,8		BR8EVX	1262	207		BR8EIX	5044
RC 50	50	01.79 -12.82	B6ES	7310	0,6		B6EVX	5136				
Red Rose 50	50	06.87 -	B9ES	2611	0,5		B9EVX	7254	202		BR9EIX	3981
RS 50 (SE)	50	01.97 -	BR8ES	5422	0,8		BR8EVX	1262	207		BR8EIX	5044
RS 50 (PG)	50	01.97 -	BR8ES	5422	0,8		BR8EVX	1262	207		BR8EIX	5044
RS 50 Extrema/Replica	50	01.93 -	B8ES	2411	0,5		B8EGV	5627	201		BR8EIX	5044
RX 50	50	09.90 -	B9ES	2611	0,5		B9EVX	7254	202		BR9EIX	3981
Tuareg 50	50	01.87 -	B9ES	2611	0,5		B9EVX	7254	202		BR9EIX	3981
AF 1 Futura	125	06.90 -	B10EG	3630	0,5		B10EGV	5927				
AF 1 Sport	125	06.90 -	B10EG	3630	0,5		B10EGV	5927				
AF1 125 Replica 89	125	03.87 -	B10EG	3630	0,6		B10EGV	5927				
AF1 125, RR, Sintesi	125	06.88 -	B10EG	3630	0,5		B10EGV	5927				
AS 125 R	125	01.91 -	B9ES	2611	0,5		B9EVX	7254	202		BR9EIX	3981
Classic 125	125	97 - 98					BR10EG	3830				
Classic 125 (MF)	125	99 -	BR8ES	5422	0,8		BR8EVX	1262	207		BR8EIX	5044
ETX 125 (PH)	125	99 -	BR8ES	5422	0,8		BR8EVX	1262	207		BR8EIX	5044
ETX 125	125	01.84 - 98	B9ES	2611	0,5		B9EVX	7254	202		BR9EIX	3981
Europa 125	125	06.90 -	B10EG	3630	0,5		B10EGV	5927				
MX 125 (TZ) 80km/h-11kW	125		BR8ES	5422	0,8		BR8EVX	1262	207		BR8EIX	5044



Order No.



Gold-Palladium



Order No.

Quick-No.







Iridium















Order No.







APRILIA

MX 125 (TZ)	18kW	125		BR10EG	3830	0,6							
Pegaso 125		125	01.92 -	B10EG	3630	0,5	B10EGV	5927					
Red Rose 125		125	01.97 -	BR8ES	5422	0,8	BR8EVX	1262	207	BR8EIX		5044	
Red Rose 125		125	01.98 -	B10EG	3630	0,5	B10EGV	5927					
RS 125 (MP/SF/PY) (11kW) (80km/h)		125	96 -	BR8ES	5422	0,8	BR8EVX	1262	207	BR8EIX		5044	
RS 125 (MP/MP/PY) (22kW)		125	99 -	BR10EG	3830	0,5							
RS 125 (MP/SF/PY) (18kW)		125	96 -	BR10EG	3830	0,5							
RS 125 Extrema/Repli. 20kW		125	- 93	BR10EG	3830	0,5							
RS 125 Extrema/Repli. 23kW		125	- 93	BR10EG	3830	0,5							
RX 125		125	01.90 -	B10EG	3630	0,5	B10EGV	5927					
ST 125		125	01.82 -	B9EG	3530	0,5	B9EGV	5827		BR9EIX		3981	
STX 125		125	01.82 -	B9EG	3530	0,5	B9EGV	5827		BR9EIX		3981	
Tuareg		125	01.86 -	B9ES	2611	0,5	B9EVX	7254	202	BR9EIX		3981	
Tuareg Rallye		125	06.89 -	B10EG	3630	0,5	B10EGV	5927					
Tuareg Wind 125		125	07.88 -	B9ES	2611	0,6	B9EVX	7254	202	BR9EIX		3981	
250 GP (I)		250		B10EG	3630	0,5	B10EGV	5927					
RS 250 ((LD)		250	95 -	BR9ECM	3252	0,5	BR9ECMVX	2434					
RX 250		250	01.85 -04.86	B10EG	3630	0,5	B10EGV	5927					
Tuareg Rally		250	01.85 -	B10EG	3630	0,5	B10EGV	5927					
Climber		276	01.89 -	BP5ES	6511	0,7	BP5EVX	5470		BPR5EIX		6597	
TX 300		276	- 84	BP5ES	6511	0,7	BP5EVX	5470		BPR5EIX		6597	
TX 311 M		276	- 84	BP5ES	6511	0,7	BP5EVX	5470		BPR5EIX		6597	
TXR 312 M		276	- 86	BP5ES	6511	0,5	BP5EVX	5470		BPR5EIX		6597	
TL 320		320	- 86	BP5ES	6511	0,5	BP5EVX	5470		BPR5EIX		6597	
EXT 350		349	01.85 -	D8EA	2120	0,5	D8EVX	2850	216	DR8EIX		6681	
Tuareg 350		349	01.87 - 91	D8EA	2120	0,5	D8EVX	2850	216	DR8EIX		6681	
Wind		349	01.87 -	D8EA	2120	0,5	D8EVX	2850	216	DR8EIX		6681	
RXV 450 Enduro (VP)		450	06 -	CR8EB	7784	0,6	CR8EVX	6487		CR8EIX		4218	
RXV 450 Supermoto (VP)		450	06 -	CR8EB	7784	0,6	CR8EVX	6487		CR8EIX		4218	
SXV 450 Supermoto (VS)		450	06 -	CR8EB	7784	0,6	CR8EVX	6487		CR8EIX		4218	
RXV 550 Enduro (VP)		550	06 -	CR8EB	7784	0,6	CR8EVX	6487		CR8EIX		4218	
RXV 550 Supermoto (VP)		550	06 -	CR8EB	7784	0,6	CR8EVX	6487		CR8EIX		4218	
SXV 550 Supermoto (VS)		550	06 -	CR8EB	7784	0,6	CR8EVX	6487		CR8EIX		4218	
Tuareg 600 Wind		562	01.88 - 93	D8EA	2120	0,6	D8EVX	2850	216	DR8EIX		6681	
Pegaso 600		600	03.90 - 94	D8EA	2120	0,6	D8EVX	2850	216	DR8EIX		6681	
Moto 6.5 (MH)		650	95 -	D8EA	2120	0,6	D8EVX	2850	216	DR8EIX		6681	
Pegaso 650(3) (ML) Kat.		650	97 - 00	DR8EA	7162	0,7	DR8EVX	6354		DR8EIX		6681	
Pegaso 650 (MX)		650	96 - 00	DR8EA	7162	0,7	DR8EVX	6354		DR8EIX		6681	
Pegaso 650 (GA)		650	04.92 - 95	DR8EA	7162	0,7	DR8EVX	6354		DR8EIX		6681	
Pegaso 650 i.e. (RW)		650	01 - 03	DR8EB	4855	0,7				DR8EIX		6681	
Pegaso 650 Trail (VD)		650	06 -	CR7E	4578	0,6			225	CR7EIX		7385	
Pegaso Cube 650		650	97 -	DR8EA	7162	0,7	DR8EVX	6354		DR8EIX		6681	
Pegaso 650 Strada (VD)		660	05 -	CR7E	4578	0,6			225	CR7EIX		7385	
SL 1000 Falco (PA)		998	99 -	DCPR9E	2641	0,7	DCPR9EVX	6436		DCPR9EIX		2316	
ETV 1000 Capo Nord (PS)		1000	01 -	DCPR9E	2641	0,7	DCPR9EVX	6436		DCPR9EIX		2316	
RST Futura (PW)		1000	01 -	DCPR9E	2641	0,7	DCPR9EVX	6436		DCPR9EIX		2316	
RSV 1000 SP (MED)		1000	99 -	R0045J-10	7400								
RSV 1000 (MEA/ME)		1000	98 -	DCPR9E	2641	0,7	DCPR9EVX	6436		DCPR9EIX		2316	
RSV 1000 Tuono (RR)		1000	04 -	DCPR9E	2641	0,7	DCPR9EVX	6436		DCPR9EIX		2316	
RSV 1000 01 (RP)		1000	01 -	DCPR9E	2641	0,7	DCPR9EVX	6436		DCPR9EIX		2316	
RSV 1000 R (RR)		1000		DCPR9E	2641	0,7	DCPR9EVX	6436		DCPR9EIX		2316	
RSV 1000 R Factory (RR)		1000	03 -	DCPR9E	2641	0,7	DCPR9EVX	6436		DCPR9EIX		2316	

						 Order No.	 Gold-Palladium	 Platin	 Order No.	 Quick-No.	 Iridium	 Order No.
APRILIA												
SL 1000 (PA)	1000	99 -	DCPR9E	2641	0,7	DCPR9EVX	6436		DCPR9EIX	2316		
Tuono Fighter 1000	1000	03 -	DCPR9E	2641	0,7	DCPR9EVX	6436		DCPR9EIX	2316		
Tuono Fighter R 1000	1000	03 -	DCPR9E	2641	0,7	DCPR9EVX	6436		DCPR9EIX	2316		
Tuono (RP)	1000	06 -	DCPR9E	2641	0,7	DCPR9EVX	6436		DCPR9EIX	2316		
ARM												
125 Velocidad Enduro	125				0,5	B10EGV	5927					
125 Cross	125				0,5	B11EGV	5831					
250 Velocidad Enduro/Cross	250				0,5	B9EGV	5827					
365 Enduro	350				0,5	B9EGV	5827					
AT MOTO												
S 3800 (Velo Solex)	50		B6HS	4510	0,6	B6HVX	7435	203	BR6HIX			3419
ATK												
50 Mini Cross	50	99 - 01	B7HS	5110	0,5	B7HVX	7836	204	BR7HIX			7067
50 MX	50	99 - 03	B7HS	5110	0,5	B7HVX	7836	204	BR7HIX			7067
125 (Wassergekühlt / Liquid Cooled)	125	99 - 03	B10ES	7928	0,5	B10EVX	7335		BR10EIX			6801
125 Enduro (Wassergekühlt / Liquid Cooled)	125	03 -	D8EA	2120	0,7	D8EVX	2850	216	DR8EIX			6681
250 (Luftgekühlt / Air Cooled)	250	88 - 96	B8ES	2411	0,5	B8EVX	7051	201	BR8EIX			5044
250 (Wassergekühlt / Liquid Cooled)	250	95 - 03	B8ES	2411	0,5	B8EVX	7051	201	BR8EIX			5044
260 (Wassergekühlt / Liquid Cooled)	260	95 - 02	B8ES	2411	0,5	B8EVX	7051	201	BR8EIX			5044
350 Cross 4 Ventil / 4 Stroke SOHC	350	91 -	D8EA	2120	0,5	D8EVX	2850	216	DR8EIX			6681
350 Enduro 4 Ventil / 4 Stroke SOHC	350	91 - 00	D8EA	2120	0,5	D8EVX	2850	216	DR8EIX			6681
350 Cross Country	350	91 - 99	D8EA	2120	0,7	D8EVX	2850	216	DR8EIX			6681
350 Enduro	350	91 - 02	D8EA	2120	0,7	D8EVX	2850	216	DR8EIX			6681
406	400	96 - 99	B8ES	2411	0,5	B8EVX	7051	201	BR8EIX			5044
406	400	88 - 96	B8ES	2411	0,5	B8EVX	7051	201	BR8EIX			5044
450 (Luftgekühlt / Air Cooled)	450	03 -	B8ES	2411	0,5	B8EVX	7051	201	BR8EIX			5044
500 DT 4 Ventil / 4 Stroke SOHC	490	99 -	D8EA	2120	0,5	D8EVX	2850	216	DR8EIX			6681
Supermot 4 Ventil / 4 Stroke SOHC	500	01 -	D8EA	2120	0,5	D8EVX	2850	216	DR8EIX			6681
Supermotard	500	01 - 02	D8EA	2120	0,7	D8EVX	2850	216	DR8EIX			6681
500 Dirt Track	500	99 - 03	D8EA	2120	0,7	D8EVX	2850	216	DR8EIX			6681
500 Enduro	500	98 - 03	D8EA	2120	0,7	D8EVX	2850	216	DR8EIX			6681
604 4 Ventil / 4 Stroke SOHC	560	93 -	D8EA	2120	0,5	D8EVX	2850	216	DR8EIX			6681
604	560	88 - 92	D8EA	2120	0,7	D8EVX	2850	216	DR8EIX			6681
600 Dirt Track (Luftgekühlt / Air Cooled)	600	98 - 03	D8EA	2120	0,7	D8EVX	2850	216	DR8EIX			6681
Supermot 4 Ventil / 4 Stroke SOHC	600	01 -	D8EA	2120	0,5	D8EVX	2850	216	DR8EIX			6681
605 DT 4 Ventil / 4 Stroke SOHC	600	98 -	D8EA	2120	0,5	D8EVX	2850	216	DR8EIX			6681
605 Cross 4 Ventil / 4 Stroke SOHC	600	93 -	D8EA	2120	0,5	D8EVX	2850	216	DR8EIX			6681
605 Cross Country	600	93 - 00	D8EA	2120	0,7	D8EVX	2850	216	DR8EIX			6681
605 Enduro 4 Ventil / 4 Stroke SOHC	600	93 - 00	D8EA	2120	0,5	D8EVX	2850	216	DR8EIX			6681
605 Enduro (Luftgekühlt / Air Cooled)	600	93 - 03	D8EA	2120	0,7	D8EVX	2850	216	DR8EIX			6681
Supermotard	600	03 -	CR9EK	4548	0,8			230	CR9EIX			3521
Supermotard	600	01 - 02	D8EA	2120	0,7	D8EVX	2850	216	DR8EIX			6681
AVIAN												
RM 125 (Tau Motor)	125				0,5	B10EGV	5927					
RM 250 (Tau Motor)	250				0,5	B8EGV	5627					
AWO												
425 T	425	56 -	B7HS	5110	0,5	B7HVX	7836	204	BR7HIX			7067

				Order No.		Gold-Palladium	Platin 	Order No.	Quick-No.	Iridium 	Order No.
B.S.A											
Tracker	125		B8ES	2411	0,5	B8EVX	7051	201	BR8EIX	5044	
Bantam 175, Bushman	175		B7ES	1111	0,5	B7EVX	6934				
Bantam D10, 14, 14/4, 14/5	175		B7ES	1111	0,5	B7EVX	6934				
Tracker	175		B8ES	2411	0,5	B8EVX	7051	201	BR8EIX	5044	
B25 R / SS Gold Star	250		B8ES	2411	0,5	B8EVX	7051	201	BR8EIX	5044	
B25 Starfire, B25T Victor	250		B8ES	2411	0,5	B8EVX	7051	201	BR8EIX	5044	
B40 SS90	350		B7ES	1111	0,5	B7EVX	6934				
A50W, B50MX, Victor MC	500		B8ES	2411	0,5	B8EVX	7051	201	BR8EIX	5044	
B50SS, Gold Star, B50T Vict.	500		B7ES	1111	0,5	B7EVX	6934				
A75 Rocket 3	750		B8ES	2411	0,6	B8EVX	7051	201	BR8EIX	5044	
BATAVUS											
G50, Mosquito, M40, TS49	50		B6HS	4510	0,5	B6HVX	7435	203	BR6HIX	3419	
Go-Go2, -V, -S	50		B6HS	4510	0,5	B6HVX	7435	203	BR6HIX	3419	
TS 49 S	50		B8HS	5510	0,5	B8HVX	2634	205	BR8HIX	7001	
BELGARDA											
DT / TDR / TZR (Yamaha)	125		B9ES	2611	0,5	B9EVX	7254	202	BR9EIX	3981	
TZR 125 R S/P (Yamaha)	125				0,5	B10EGV	5927				
BENELLI											
G2, Elle, Pedali	50	01.83 -06.89	B6HS	4510	0,5	B6HVX	7435	203	BR6HIX	3419	
Gentleman, Magnum 5V	50		B5ES	6410	0,5						
Laser	50	01.84 -06.89	B6HS	4510	0,5	B6HVX	7435	203	BR6HIX	3419	
Magnum 3V	50		B7ES	1111	0,5	B7EVX	6934				
S50	50	04.81 -06.89	B6HS	4510	0,5	B6HVX	7435	203	BR6HIX	3419	
Spring 50	50		B8ES	2411	0,5	B8EVX	7051	201	BR8EIX	5044	
125	125		B6HS	4510	0,5	B6HVX	7435	203	BR6HIX	3419	
125-2C Twin	125		B7ES	1111	0,5	B7EVX	6934				
Jarno	125		B8ES	2411	0,5	B8EVX	7051	201	BR8EIX	5044	
Scooter S-125	125		B7HS	5110	0,5	B7HVX	7836	204	BR7HIX	7067	
304	230	09.82 -	B7HS	5110	0,6	B7HVX	7836	204	BR7HIX	7067	
250	250		B6ES	7310	0,5	B6EVX	5136				
250 Quattro	250	10.77 -06.80	B7HS	5110	0,6	B7HVX	7836	204	BR7HIX	7067	
254	250	01.80 -07.82	B7HS	5110	0,6	B7HVX	7836	204	BR7HIX	7067	
2C, 2CE, Sport Speciale	250		B7ES	1111	0,5	B7EVX	6934				
500 LS, Quattro, 504 / Sport	500		D8EA	2120	0,5	D8EVX	2850	216	DR8EIX	6681	
654 / Sport / 4C	650		D8EA	2120	0,5	D8EVX	2850	216	DR8EIX	6681	
Tornado 650/S/SV	650		B8ES	2411	0,5	B8EVX	7051	201	BR8EIX	5044	
750 Sei	750		D8EA	2120	0,5	D8EVX	2850	216	DR8EIX	6681	
900 Sei VT/NT	900		D8EA	2120	0,5	D8EVX	2850	216	DR8EIX	6681	
Tornado RS / LE	900	05 -	C7E	5096	0,6				CR7EIX	7385	
Tornado TRE	900	05 -	C7E	5096	0,6				CR7EIX	7385	
Tornado 900	900	00 -	CR9E	6263	0,7	CR9EVX	5943	227	CR9EIX	3521	
TNT 1130	1130	05 -	CR9E	6263	0,7	CR9EVX	5943	227	CR9EIX	3521	
TNT 1130 Cafe Racer	1130	06 -	CR9E	6263	0,7	CR9EVX	5943	227	CR9EIX	3521	
BENETTI											
Stilo / AI	50		B6HS	4510	0,5	B6HVX	7435	203	BR6HIX	3419	
BETA											
ALP 50	50	93 -	B8ES	2411	0,5	B8EVX	7051	201	BR8EIX	5044	

					Order No.		Platin 	Order No.	Quick-No. 	Iridium	Order No.
BETA											
Bad			B9ES	2611	0,5	B9EVX	7254	202	BR9EIX		3981
KR-50			B6ES	7310	0,5	B6EVX	5136				
Minicross 10/10		00 -	B7HS	5110	0,5	B7HVX	7836	204	BR7HIX		7067
Minicross 12/15		00 -	B7HS	5110	0,5	B7HVX	7836	204	BR7HIX		7067
Minitrail		00 -	B7HS	5110	0,5	B7HVX	7836	204	BR7HIX		7067
Motard 50	Euro2		BR9ES	5722	0,6	BR9EVX	1265	208	BR9EIX		3981
Motard 50 Racing	Euro2		BR9ES	5722	0,6	BR9EVX	1265	208	BR9EIX		3981
Motard 50 Alu	Euro2		BR9ES	5722	0,6	BR9EVX	1265	208	BR9EIX		3981
MX 50		93 -	B9ES	2611	0,5	B9EVX	7254	202	BR9EIX		3981
REV 50		04 -	B9ES	2611	0,5	B9EVX	7254	202	BR9EIX		3981
RK 6-50			B8ES	2411	0,5	B8EVX	7051	201	BR8EIX		5044
RR 50 Enduro Racing	Euro2		BR9ES	5722	0,6	BR9EVX	1265	208	BR9EIX		3981
RR 50 Enduro	Euro2		BR9ES	5722	0,6	BR9EVX	1265	208	BR9EIX		3981
RR 50 Enduro Alu	Euro2		BR9ES	5722	0,6	BR9EVX	1265	208	BR9EIX		3981
RR Enduro			B10ES	7928	0,5	B10EVX	7335		BR10EIX		6801
Super Trail			B8ES	2411	0,5	B8EVX	7051	201	BR8EIX		5044
Supermotard 50			B10ES	7928	0,5	B10EVX	7335		BR10EIX		6801
Tempo / Crono			BR7HS	4122	0,5			211	BR7HIX		7067
Tempo 50			BR7HS	4122	0,5			211	BR7HIX		7067
Tempo Crono			BR7HS	4122	0,5			211	BR7HIX		7067
TR-50			B6ES	7310	0,5	B6EVX	5136				
Zero 50			B9ES	2611	0,5	B9EVX	7254	202	BR9EIX		3981
M4 4-T			CR9EK	4548	0,8			230	CR9EIX		3521
REV 80		04 -	B9ES	2611	0,5	B9EVX	7254	202	BR9EIX		3981
Dougie Lampkin Replica			B8ES	2411	0,5	B8EVX	7051	201	BR8EIX		5044
Alp 125			CR7HSA	4549	0,8				CR7HIX		7544
Alp 4T		00 -	DR8EA	7162	0,7	DR8EVX	6354		DR8EIX		6681
REV 3		00 -	B8ES	2411	0,5	B8EVX	7051	201	BR8EIX		5044
RR 125 Enduro	Euro2		CR7HSA	4549	0,8				CR7HIX		7544
RR 125 Motard	Euro2		CR7HSA	4549	0,8				CR7HIX		7544
Techno 125			BP7ES	2412	0,6	BP7EVX	7270	206	BPR7EIX		4055
TR-34			B8ES	2411	0,5	B8EVX	7051	201	BR8EIX		5044
Zero 125			B8ES	2411	0,5	B8EVX	7051	201	BR8EIX		5044
Alp			DR8EA	7162	0,7	DR8EVX	6354		DR8EIX		6681
Alp 4-T		00 -	DR8EA	7162	0,7	DR8EVX	6354		DR8EIX		6681
REV 3			BP7ES	2412	0,5	BP7EVX	7270	206	BPR7EIX		4055
TR-33			B6ES	7310	0,5	B6EVX	5136				
Dougie Lampkin Replica			BP7ES	2412	0,5	BP7EVX	7270	206	BPR7EIX		4055
Alp 250			B8ES	2411	0,5	B8EVX	7051	201	BR8EIX		5044
REV 3		00 -	B8ES	2411	0,5	B8EVX	7051	201	BR8EIX		5044
RR 250M 4-T			DCPR8E	4339	0,9	DCPR8EVX	2265		DCPR8EIX		6546
Super Trail 250			B8ES	2411	0,5	B8EVX	7051	201	BR8EIX		5044
Techno			BCP7ES	5030	0,5	BCP7EV	3733		BCP7EIX		5690
Alp			B8ES	2411	0,5	B8EVX	7051	201	BR8EIX		5044
Super Trail			B8ES	2411	0,5	B8EVX	7051	201	BR8EIX		5044
Synt 260			B8ES	2411	0,5	B8EVX	7051	201	BR8EIX		5044
TR-34/Campionato			B8ES	2411	0,5	B8EVX	7051	201	BR8EIX		5044
Zero			B8ES	2411	0,5	B8EVX	7051	201	BR8EIX		5044
Alp 4.0 4-T		03 -	CR9EK	4548	0,7			230	CR9EIX		3521
Euro 350			CR9EK	4548	0,7			230	CR9EIX		3521
Jonathan 350			CR9EK	4548	0,7			230	CR9EIX		3521
Motard 4.0 4-T		03 -	CR9EK	4548	0,7			230	CR9EIX		3521

					Order No.		Platin 	Order No.	Quick-No.	Iridium 	Order No.
BETA											
RR 400 4-T	400		DCPR8E	4339	0,9	DCPR8EVX	2265			DCPR8EIX	6546
RR 450 4-T	450		DCPR8E	4339	0,9	DCPR8EVX	2265			DCPR8EIX	6546
RR 525 4-T	525		DCPR8E	4339	0,9	DCPR8EVX	2265			DCPR8EIX	6546
BIG DOG											
all models	1310		BPR5ES-11	4424	1,1	BPR5EVX-11	2738			BPR5EIX-11	2115
88 cu in	1440		BPR5ES-11	4424	1,1	BPR5EVX-11	2738			BPR5EIX-11	2115
all models	1507		BPR5ES-11	4424	1,1	BPR5EVX-11	2738			BPR5EIX-11	2115
S&S Engine 107 cu in	1750		BPR5ES-11	4424	1,1	BPR5EVX-11	2738			BPR5EIX-11	2115
Total Performance Eng.	1750		DCPR7E	3932	0,8	DCPR7EVX	1179			DCPR7EIX	6046
S&S Engine 117 cu in	1918		DCPR7E	3932	0,8	DCPR7EVX	1179			DCPR7EIX	6046
BIMOTA											
YB-9 Bellaria	600		CR9E	6263	0,7	CR9EVX	5943	227		CR9EIX	3521
YB-9 SR	600	95 -	CR9E	6263	0,7	CR9EVX	5943	227		CR9EIX	3521
BB 1 Supermono / Bipošto	650	95 -	D8EA	2120	0,7	D8EVX	2850	216		DR8EIX	6681
DB-1/S	750		BP7HS	5111	0,5	BP7HVX	7468			BPR7HIX	5944
SB 7	750		CR9EK	4548	0,7			230		CR9EIX	3521
YB-4	750		DR8EA	7162	0,7	DR8EVX	6354			DR8EIX	6681
Tesi 1	851	92 -			0,6	D9EVX	2834			DR9EIX	4772
DB-2	900	92 -	DPR8EA-9	4929	0,9	DPR8EVX-9	2872	221		DPR8EIX-9	2202
DB-2 SR	900		DPR8EA-9	4929	0,9	DPR8EVX-9	2872	221		DPR8EIX-9	2202
DB-3 Mantra	904	95 -	DPR8EA-9	4929	0,9	DPR8EVX-9	2872	221		DPR8EIX-9	2202
SB 8 R	1000	99 -	CR9EK	4548	0,7			230		CR9EIX	3521
YB-6	1000		DR8ESL	2923	0,7	DR8EVX	6354	218		DR8EIX	6681
YB-8 EXUP	1000	95 -	DR8ESL	2923	0,7	DR8EVX	6354	218		DR8EIX	6681
YB 11	1002	96 -	DR8EA	7162	0,7	DR8EVX	6354			DR8EIX	6681
SB 6	1100		CR9E	6263	0,7	CR9EVX	5943	227		CR9EIX	3521
SB 6 R	1100	97 -	CR9E	6263	0,7	CR9EVX	5943	227		CR9EIX	3521
SB-5/S	1150		DPR9EA-9	5329	0,9	DPR9EVX-9	3854	222		DPR9EIX-9	5545
YB-5	1200		DPR8EA-9	4929	0,9	DPR8EVX-9	2872	221		DPR8EIX-9	2202
BLATA											
Elite 13	40		B9ES	2611	0,5	B9EVX	7254	202		BR9EIX	3981
Elite 13 W R	40				0,5	B9EGV	5827				
Elite 13 R	40				0,5	B9EGV	5827				
Elite 13 / 13W	40		B9ES	2611	0,5	B9EVX	7254	202		BR9EIX	3981
Elite 13 W	40		B9ES	2611	0,8	B9EVX	7254	202		BR9EIX	3981
Elite 13S / 13WR / 13WRS	40				0,5	B9EGV	5827				
Elite 13 W R S	40				0,5	B9EGV	5827				
BMW											
R 20 (220/1)	192	37 - 38	B6HS	4510	0,7	B6HVX	7435	203		BR6HIX	3419
R 23 (223/1)	192	38 - 40	B6HS	4510	0,7	B6HVX	7435	203		BR6HIX	3419
R 24	250	48 - 50	B8HS	5510	0,6	B8HVX	2634	205		BR8HIX	7001
R 25	250	50 - 51	B8HS	5510	0,6	B8HVX	2634	205		BR8HIX	7001
R 25/2	250	51 - 53	B8HS	5510	0,6	B8HVX	2634	205		BR8HIX	7001
R 25/3	250	53 - 56	B8HS	5510	0,6	B8HVX	2634	205		BR8HIX	7001
R 26	250	56 - 60	B8HS	5510	0,6	B8HVX	2634	205		BR8HIX	7001
R 27	250	60 - 67	B8HS	5510	0,6	B8HVX	2634	205		BR8HIX	7001
R 51/2	250	50 - 51	B8HS	5510	0,6	B8HVX	2634	205		BR8HIX	7001
R 51/3	250	51 - 54	B8HS	5510	0,6	B8HVX	2634	205		BR8HIX	7001



Order No.



Gold-Palladium



Platin

Order No.

Quick-No.

Iridium



Order No.

BMW

R 3 (203/1)	305	36 - 36	B6HS	4510	0,7	B6HVX	7435	203	BR6HIX	3419
R 45 20kW	475	06.78 -07.85	BP6ES	7811	0,6	BP6EVX	5832		BPR6EIX	6637
R 45 26kW	475	06.78 -06.83	BP7ES	2412	0,6	BP7EVX	7270	206	BPR7EIX	4055
R 5 (254)	494	36 - 37	B7HS	5110	0,7	B7HVX	7836	204	BR7HIX	7067
R 50	500	55 - 69	B8HS	5510	0,6	B8HVX	2634	205	BR8HIX	7001
R 50/5	500		BP7ES	2412	0,6	BP7EVX	7270	206	BPR7EIX	4055
R 50S	500	60 - 62	B8HS	5510	0,6	B8HVX	2634	205	BR8HIX	7001
R 52	500	28 - 29	B6HS	4510	0,6	B6HVX	7435	203	BR6HIX	3419
R 6 (261)	600	37 - 37	B6HS	4510	0,7	B6HVX	7435	203	BR6HIX	3419
R 60	600	56 - 69	B8HS	5510	0,6	B8HVX	2634	205	BR8HIX	7001
R 60/5, /6, /7	600	-06.78	BP7ES	2412	0,6	BP7EVX	7270	206	BPR7EIX	4055
R 67	600	51 -	B8HS	5510	0,6	B8HVX	2634	205	BR8HIX	7001
R 67/2	600	52 - 54	B8HS	5510	0,6	B8HVX	2634	205	BR8HIX	7001
R 68	600	52 - 54	B8HS	5510	0,6	B8HVX	2634	205	BR8HIX	7001
R 69	600	55 - 60	B8HS	5510	0,6	B8HVX	2634	205	BR8HIX	7001
R 69S	600	60 - 69	B8HS	5510	0,6	B8HVX	2634	205	BR8HIX	7001
F 650 TwinSpark (BMS-C II)	650	09.04 -	DR8EB	4855	0,6				DR8EIX	6681
F 650 25kW	650	93 - 99	D8EA	2120	0,7	D8EVX	2850	216	DR8EIX	6681
F 650 35kW	650	93 - 99	D8EA	2120	0,7	D8EVX	2850	216	DR8EIX	6681
F 650 ST 35kW	650	97 - 99	D8EA	2120	0,6	D8EVX	2850	216	DR8EIX	6681
F 650 GS 25kW	650	00 -08.03	D8EA	2120	0,6	D8EVX	2850	216	DR8EIX	6681
F 650 CS	650	02 -08.03	DR8EB	4855	0,6				DR8EIX	6681
F 650 GS 37kW	650	00 -08.03	D8EA	2120	0,6	D8EVX	2850	216	DR8EIX	6681
R 65	650	06.78 -	BP7ES	2412	0,6	BP7EVX	7270	206	BPR7EIX	4055
R 16 Serie 1-5	736	29 - 35	B6HS	4510	0,7	B6HVX	7435	203	BR6HIX	3419
R 17 (M60)	736	35 - 37	A6	1010	0,7					
R 11 Serie 1-5	745	29 - 34	B6HS	4510	0,7	B6HVX	7435	203	BR6HIX	3419
R 12 2-Vergaser (M56S6&212)	745	35 - 42	B6HS	4510	0,7	B6HVX	7435	203	BR6HIX	3419
K 75	750	06.85 - 96	D7EA	7912	0,6	D7EVX	2734			
K 75 RT	750	- 96	D7EA	7912	0,6	D7EVX	2734			
K 75 S	750	- 96	D7EA	7912	0,6	D7EVX	2734			
R 71 (271/1)	750	38 - 41	B6HS	4510	0,6	B6HVX	7435	203	BR6HIX	3419
R 75/5, /6, /7	750		BP6ES	7811	0,6	BP6EVX	5832		BPR6EIX	6637
F 800 GS	800	06 -	DCPR8E	4339	0,9	DCPR8EVX	2265		DCPR8EIX	6546
F 800 S	800	06 -	DCPR8E	4339	0,9	DCPR8EVX	2265		DCPR8EIX	6546
F 800 ST	800	06 -	DCPR8E	4339	0,9	DCPR8EVX	2265		DCPR8EIX	6546
R 80 R	800	80 -	BP6ES	7811	0,7	BP6EVX	5832		BPR6EIX	6637
R 80 GS	800	08.82 - 94	BP6ES	7811	0,7	BP6EVX	5832		BPR6EIX	6637
R 80 RT	800	08.82 - 95	BP6ES	7811	0,7	BP6EVX	5832		BPR6EIX	6637
R 80 ST	800	08.82 - 95	BP6ES	7811	0,7	BP6EVX	5832		BPR6EIX	6637
R 80	800	08.82 - 95	BP6ES	7811	0,7	BP6EVX	5832		BPR6EIX	6637
R 80/7N /7S	800	09.77 -08.80	BP6ES	7811	0,7	BP6EVX	5832		BPR6EIX	6637
R 850 GS	850	98 -	BKR7EK	7354					BKR7EIX	2667
R 850 R 52kW	850	10.94 -	BKR7EK	7354					BKR7EIX	2667
R 850 RT	850	99 -	BKR7EK	7354					BKR7EIX	2667
R 90/6	900		BP6ES	7811	0,6	BP6EVX	5832		BPR6EIX	6637
R 90/S	900		BP7ES	2412	0,6	BP7EVX	7270	206	BPR7EIX	4055
K 100 LT / RT 65kW	1000	09.83 -11.91	D7EA	7912	0,5	D7EVX	2734			
K 100 RS 4V	1000		DR7EA	7839	0,6					
K 100 RS 65kW	1000	09.83 -12.89	D7EA	7912	0,6	D7EVX	2734			
K 100 RS 72-74kW	1000	01.90 - 93	D7EA	7912	0,6	D7EVX	2734			
K 1 72-74kW	1000	05.89 - 93	DR7EA	7839	0,6					



Order No.



Gold-Palladium



Order No.

Quick-No.

Iridium



Order No.

BMW

R 100 R		1000	94 -	BP6ES	7811	0,6	BP6EVX	5832		BPR6EIX	6637
R 100		1000		BP7ES	2412	0,6	BP7EVX	7270	206	BPR7EIX	4055
R 100 RS		1000	09.86 -	BP6ES	7811	0,6	BP6EVX	5832		BPR6EIX	6637
R 100/7		1000		BP6ES	7811	0,6	BP6EVX	5832		BPR6EIX	6637
R 100/GS/RT		1000		BP7ES	2412	0,6	BP7EVX	7270	206	BPR7EIX	4055
R 100/RS		1000	-08.86	BP7ES	2412	0,6	BP7EVX	7270	206	BPR7EIX	4055
R 100 GS		1000	09.86 -	BP6ES	7811	0,6	BP6EVX	5832		BPR6EIX	6637
R 100/S /T		1000	09.76 -08.80	BP7ES	2412	0,6	BP7EVX	7270	206	BPR7EIX	4055
K 1100 LT 72-74kW		1100	01.92 - 98	DR7EA	7839	0,6					
K 1100 RS 72-74kW		1100	01.92 - 96	DR7EA	7839	0,6					
R 1100 S all models Twinspark		1100	01.03 -	BKR7EKC + DCPR8EKC	7354+ 7168					BKR7EIX + DCPR8EIX	2667+ 6546
R 1100 GS 59kW		1100	08.93 - 99	BCP7ET	2078	0,8				BCPR7EIX	5690
R 1100 R 59kW		1100	10.94 - 01	BCP7ET	2078	0,8				BCPR7EIX	5690
R 1100 RS 66kW		1100	11.92 - 01	BCP7ET	2078	0,8				BCPR7EIX	5690
R 1100 RT 66kW		1100	09.95 - 01	BCP7ET	2078	0,8				BCPR7EIX	5690
R 1100 S Boxer Cup not twinspark		1100	02 - 03	BKR7EKC	7354					BKR7EIX	2667
R 1100 S 72kW not twinspark		1100	98 - 03	BKR7EKC	7354					BKR7EIX	2667
R 1150 all models Twinspark		1150	01.03 -	BKR7EKC + DCPR8EKC	7354+ 7168					BKR7EIX + DCPR8EIX	2667+ 6546
R 1150 GS Adventure not twinspark		1150	02 - 03	BKR7EKC	7354					BKR7EIX	2667
R 1150 GS not twinspark		1150	99 - 03	BKR7EKC	7354					BKR7EIX	2667
R 1150 R not twinspark		1150	01 - 03	BKR7EKC	7354					BKR7EIX	2667
R 1150 RT not twinspark		1150	01 - 03	BKR7EKC	7354					BKR7EIX	2667
HP2 77kW		1200	05 -	BKR7EKC + DCPR8EKC	7354+ 7168					BKR7EIX + DCPR8EIX	2667+ 6546
K 1200 RS 72kW		1200	97 -	DCPR7E	3932	0,8	DCPR7EVX	1179		DCPR7EIX	6046
K 1200 RS 96kW		1200	97 -	DCPR7E	3932	0,8	DCPR7EVX	1179		DCPR7EIX	6046
K 1200 LT		1200	98 -	DCPR7E	3932	0,8	DCPR7EVX	1179		DCPR7EIX	6046
K 1200 GT		1200	03 - 05	DCPR7E	3932	0,8	DCPR7EVX	1179		DCPR7EIX	6046
K 1200 R		1200	05 -	KR9CI							
K 1200 GT		1200	06 -	KR9CI							
K 1200 LT 72kW		1200	97 -	DCPR7E	3932	0,8	DCPR7EVX	1179		DCPR7EIX	6046
K 1200 LT 85kW		1200	04 -	DCPR7E	3932	0,8	DCPR7EVX	1179		DCPR7EIX	6046
K 1200 S		1200	10.04 -	KR9CI							
R 1200 C		1200		BKR7EKC	7354					BKR7EIX	2667
R 1200 S twinspark		1200	06 -	DCPR8EKC	7168					DCPR8EIX	6546
R 1200 R twinspark		1200	07 -	DCPR8EKC	7168					DCPR8EIX	6546
R 1200 RT twinspark		1200	05 -	DCPR8EKC	7168					DCPR8EIX	6546
R 1200 ST twinspark		1200	05 -	DCPR8EKC	7168					DCPR8EIX	6546
R 1200 GS twinspark		1200	04 -	DCPR8EKC	7168					DCPR8EIX	6546
R 1200 CL		1200	03 -	BKR7EKC	7354					BKR7EIX	2667

BOOM TRIKE

Classic Trike Chopper VW (Vergaser ohne Leistungssteigerung)	1600			B6HS	4510	0,6	B6HVX	7435	203	BR6HIX	3419
Classic Trike Chopper VW (Vergaser mit Leistungssteigerung)	1600			B7HS	5110	0,6	B7HVX	7836	204	BR7HIX	7067
Classic Trike Chopper VW (Einspritzer ohne Leistungssteigerung)	1600			BP5ESA	2285	0,8				BPR5EIX	6597
Classic Trike Family VW (Einspritzer ohne Leistungssteigerung)	1600			BP5ESA	2285	0,8				BPR5EIX	6597



Order No.



Gold-Palladium



Platin

Order No.

Quick-No.

Iridium



Order No.

BOOM TRIKE

Classic Trike Family VW (Vergaser ohne Leistungssteigerung)	1600			B6HS	4510	0,6	B6HVX	7435	203	BR6HIX	3419
Classic Trike Family VW (Vergaser mit Leistungssteigerung)	1600			B7HS	5110	0,6	B7HVX	7836	204	BR7HIX	7067
Classic Trike Low Rider VW (Vergaser ohne Leistungssteigerung)	1600			B6HS	4510	0,6	B6HVX	7435	203	BR6HIX	3419
Classic Trike Low Rider VW (Vergaser mit Leistungssteigerung)	1600			B7HS	5110	0,6	B7HVX	7836	204	BR7HIX	7067
Classic Trike Low Rider VW (Einspritzer ohne Leistungssteigerung)	1600			BP5ESA	2285	0,8				BPR5EIX	6597
Fighter Automatik FORD Motor	1600			PTR5A-13	2467	1,3					
Fighter Automatik FORD Motor	2000			PTR5A-13	2467	1,3					

BOSS

HOSS	8226			BPR4ES	7222	0,7	BPR4EVX	3436			
------	------	--	--	---------------	------	-----	----------------	------	--	--	--

BSA

A 7	500	47 -	62	B7HCS	2421	0,7					
-----	-----	------	----	--------------	------	-----	--	--	--	--	--

BSM







City	50	99 -	01	BPR7HS	6422	0,6	BPR7HVX	2938	215	BPR7HIX	5944
Off Road	50	99 -	01	BPR7HS	6422	0,6	BPR7HVX	2938	215	BPR7HIX	5944
Thunderbike	50	99 -		BPR7HS	6422	0,6	BPR7HVX	2938	215	BPR7HIX	5944
Winner	50	99 -		BPR7HS	6422	0,6	BPR7HVX	2938	215	BPR7HIX	5944
Thunderbike 2	100	99 -		BPR7HS	6422	0,6	BPR7HVX	2938	215	BPR7HIX	5944
125	125	99 -		DR8EA	7162	0,7	DR8EVX	6354		DR8EIX	6681
Thunderbike 4	125	99 -		CR7HSA	4549	0,7				CR7HIX	7544







BUELL

RR 1000	1000	87 -	88	DCPR7E	3932	1,0	DCPR7EVX	1179		DCPR7EIX	6046
XB9R	1000	01 -		DCPR9E	2641	0,9	DCPR9EVX	6436		DCPR9EIX	2316
XB9S	1000	03 -		DCPR9E	2641	0,9	DCPR9EVX	6436		DCPR9EIX	2316
XB9S	1000	05 -		DCPR9E	2641	0,9	DCPR9EVX	6436		DCPR9EIX	2316
XB9SX	1000	05 -		DCPR9E	2641	0,9	DCPR9EVX	6436		DCPR9EIX	2316
M2 Cyclone	1200	97 -	98	DCPR7E	3932	1,0	DCPR7EVX	1179		DCPR7EIX	6046
RSS 1200/ RS/ RR	1200	89 -	94	DCPR7E	3932	1,0	DCPR7EVX	1179		DCPR7EIX	6046
S1 Lightning	1200	96 -	97	DCPR7E	3932	1,0	DCPR7EVX	1179		DCPR7EIX	6046
S1 White Lightning	1200	98 -		DCPR7E	3932	1,0	DCPR7EVX	1179		DCPR7EIX	6046
S2 Thunderbolt	1200	95 -	96	DCPR7E	3932	1,0	DCPR7EVX	1179		DCPR7EIX	6046
S3 Thunderbolt	1200	97 -		DCPR7E	3932	1,0	DCPR7EVX	1179		DCPR7EIX	6046
X1 Lightning	1200	99 -		DCPR7E	3932	1,0	DCPR7EVX	1179		DCPR7EIX	6046
XB 12 S	1200	04 -		DCPR9E	2641	0,9	DCPR9EVX	6436		DCPR9EIX	2316
XB 12 Ss	1200	06 -		DCPR9E	2641	0,9	DCPR9EVX	6436		DCPR9EIX	2316
XB 12 X	1200	06 -		DCPR9E	2641	0,9	DCPR9EVX	6436		DCPR9EIX	2316

BULTACO

49/GT	50			B5HS	4210	0,5					
Astro	50	98 -		B9ES	2611	0,5	B9EVX	7254	202	BR9EIX	3981
Chispa	50			B5HS	4210	0,5					
Lobito	50	98 -		B9ES	2611	0,5	B9EVX	7254	202	BR9EIX	3981
Tiron	50			B5HS	4210	0,5					
Brinco	75			B7HS	5110	0,5	B7HVX	7836	204	BR7HIX	7067

					Order No.		Platin 	Order No.	Quick-No.	Iridium 	Order No.
BULTACO											
Frontera	75		B8HS	5510	0,5	B8HVX	2634	205	BR8HIX	7001	
Junior GT2	75		B7HS	5110	0,5	B7HVX	7836	204	BR7HIX	7067	
Lobito	75		B6HS	4510	0,5	B6HVX	7435	203	BR6HIX	3419	
Sherpa T	75		B6HS	4510	0,5	B6HVX	7435	203	BR6HIX	3419	
Streaker	75		B6HS	4510	0,5	B6HVX	7435	203	BR6HIX	3419	
Junior	100		B6HS	4510	0,5	B6HVX	7435	203	BR6HIX	3419	
Lobito	100		B6HS	4510	0,5	B6HVX	7435	203	BR6HIX	3419	
Lobito K	100		B9HS	5810	0,5	B9HVX	2254				
Sherpa S	100		B9HS	5810	0,5	B9HVX	2254				
Tiron	100		B6HS	4510	0,5	B6HVX	7435	203	BR6HIX	3419	
Alpina	125		BP5ES	6511	0,5	BP5EVX	5470		BPR5EIX	6597	
Frontera	125		B6HS	4510	0,5	B6HVX	7435	203	BR6HIX	3419	
Junior	125		B6HS	4510	0,5	B6HVX	7435	203	BR6HIX	3419	
Lobito MK3/MK6	125		BP5ES	6511	0,5	BP5EVX	5470		BPR5EIX	6597	
Lobito MK7	125		B6HS	4510	0,5	B6HVX	7435	203	BR6HIX	3419	
Mercurio	125		B6HS	4510	0,5	B6HVX	7435	203	BR6HIX	3419	
Pursang MK5	125		B10EG	3630	0,5	B10EGV	5927				
Pursang MK6	125		B9EG	3530	0,5	B9EGV	5827		BR9EIX	3981	
Sherco	125	00 -	BPR5ES	7422	0,6	BPR5EVX	4875		BPR5EIX	6597	
Sherpa S	125		B9EG	3530	0,5	B9EGV	5827		BR9EIX	3981	
Sherpa T	125		B6HS	4510	0,5	B6HVX	7435	203	BR6HIX	3419	
Streaker	125		B6HS	4510	0,5	B6HVX	7435	203	BR6HIX	3419	
Tralla	125		B6HS	4510	0,5	B6HVX	7435	203	BR6HIX	3419	
Campera	150		B6HS	4510	0,5	B6HVX	7435	203	BR6HIX	3419	
Mercurio/GT/150	150		B6HS	4510	0,5	B6HVX	7435	203	BR6HIX	3419	
Tralla	150		B6HS	4510	0,5	B6HVX	7435	203	BR6HIX	3419	
Alpina	175		BP5ES	6511	0,5	BP5EVX	5470		BPR5EIX	6597	
Campera MK2	175		B5ES	6410	0,5						
Lobito MK6	175		BP5ES	6511	0,5	BP5EVX	5470		BPR5EIX	6597	
Lobito MK7	175		B5ES	6410	0,5						
Mercurio	175		B6HS	4510	0,5	B6HVX	7435	203	BR6HIX	3419	
Mercurio GT	175		BP5ES	6511	0,5	BP5EVX	5470		BPR5EIX	6597	
Pursang MK5	175		B9EG	3530	0,5	B9EGV	5827		BR9EIX	3981	
Sherpa MK3	175		B9EG	3530	0,5	B9EGV	5827		BR9EIX	3981	
El Tigre	200		B8ES	2411	0,5	B8EVX	7051	201	BR8EIX	5044	
Go Kart	200		B9EG	3530	0,5	B9EGV	5827		BR9EIX	3981	
Mercurio	200		B8ES	2411	0,5	B8EVX	7051	201	BR8EIX	5044	
Metise	200		B8ES	2411	0,5	B8EVX	7051	201	BR8EIX	5044	
Pursang MK5	200		B9EG	3530	0,5	B9EGV	5827		BR9EIX	3981	
Senior	200		B8ES	2411	0,5	B8EVX	7051	201	BR8EIX	5044	
Sherco	200	00 -	BPR5ES	7422	0,6	BPR5EVX	4875		BPR5EIX	6597	
Sherpa MK3	200		B9EG	3530	0,5	B9EGV	5827		BR9EIX	3981	
Sherpa S	200		B7ES	1111	0,5	B7EVX	6934				
Alpina	250		BP5ES	6511	0,5	BP5EVX	5470		BPR5EIX	6597	
Astro	250		B9EG	3530	0,5	B9EGV	5827		BR9EIX	3981	
Frontera	250		B8ES	2411	0,5	B8EVX	7051	201	BR8EIX	5044	
Matador 250/SD	250		BP5ES	6511	0,5	BP5EVX	5470		BPR5EIX	6597	
Matador MK2/MK3	250		B8ES	2411	0,5	B8EVX	7051	201	BR8EIX	5044	
Matador MK4	250		BP6ES	7811	0,5	BP6EVX	5832		BPR6EIX	6637	
Metrala GT/MK2/MK250	250		B8ES	2411	0,5	B8EVX	7051	201	BR8EIX	5044	
Metrala GTS	250		BP5ES	6511	0,5	BP5EVX	5470		BPR5EIX	6597	
Pursang MK4/MK5 lado admis	250		B8ES	2411	0,5	B8EVX	7051	201	BR8EIX	5044	

					Order No.		Platin 	Order No.	Quick-No.	Iridium 	Order No.
BULTACO											
Pursang MK4/MK5 lado escap	250		B9EG	3530	0,5	B9EVX	7254			BR9EIX	3981
Pursang MK6/MK7 lado admis	250		B8ES	2411	0,5	B8EVX	7051	201		BR8EIX	5044
Pursang MK6/MK7 lado escap	250		B9EG	3530	0,5	B9EGV	5827			BR9EIX	3981
Sherco	250	99 -	BPR5ES	7422	0,6	BPR5EVX	4875			BPR5EIX	6597
Sherpa S	250		B9EG	3530	0,5	B9EGV	5827			BR9EIX	3981
Sherpa T	250		BP5ES	6511	0,5	BP5EVX	5470			BPR5EIX	6597
Sherco	290	00 -	BPR5ES	7422	0,6	BPR5EVX	4875			BPR5EIX	6597
Alpina	350		BP5ES	6511	0,5	BP5EVX	5470			BPR5EIX	6597
Matador MK9/MK10	350		BP5ES	6511	0,5	BP5EVX	5470			BPR5EIX	6597
Pursang MK5/MK6 lado admis	350		B8ES	2411	0,5	B8EVX	7051	201		BR8EIX	5044
Pursang MK5/MK6 lado escap	350		B9EG	3530	0,5	B9EGV	5827			BR9EIX	3981
Sherpa T	350		BP5ES	6511	0,5	BP5EVX	5470			BPR5EIX	6597
Astro lado admision	360		B8ES	2411	0,5	B8EVX	7051	201		BR8EIX	5044
Astro lado escape	360		B9EG	3530	0,5	B9EGV	5827			BR9EIX	3981
El Bandito MK2 lado admis.	360		B8ES	2411	0,5	B8EVX	7051	201		BR8EIX	5044
El Bandito MK2 lado escape	360		B9EG	3530	0,5	B9EGV	5827			BR9EIX	3981
Frontera	360		B8ES	2411	0,5	B8EVX	7051	201		BR8EIX	5044
Pursang lado admision	360		B8ES	2411	0,5	B8EVX	7051	201		BR8EIX	5044
Pursang lado escape	360		B9EG	3530	0,5	B9EGV	5827			BR9EIX	3981
Frontera MK11	370		B8ES	2411	0,5	B8EVX	7051	201		BR8EIX	5044
Pursang lado admision	370		B8ES	2411	0,5	B8EVX	7051	201		BR8EIX	5044
Pursang lado escape	370		B9EG	3530	0,5	B9EGV	5827			BR9EIX	3981
Pursang MK15	450		B8ES	2411	0,5	B8EVX	7051	201		BR8EIX	5044
CAGIVA											
City	50	98 -	BR8HSA	5539	0,5	BR8HVX	6265			BR8HIX	7001
Cocis	50		B8ES	2411	0,5	B8EVX	7051	201		BR8EIX	5044
K3	50		B8ES	2411	0,5	B8EVX	7051	201		BR8EIX	5044
Prima	50		B8ES	2411	0,5	B8EVX	7051	201		BR8EIX	5044
Supercity	50		B8ES	2411	0,5	B8EVX	7051	201		BR8EIX	5044
W4	50		B8ES	2411	0,5	B8EVX	7051	201		BR8EIX	5044
Cocis	75		B8ES	2411	0,5	B8EVX	7051	201		BR8EIX	5044
125 Elefant 2	125		B9EG	3530	0,5	B9EGV	5827			BR9EIX	3981
Aletta Electra, Oro	125	84 -	B9ES	2611	0,5	B9EVX	7254	202		BR9EIX	3981
Aletta Oro 125/S1	125	07.85 -12.85	B9EG	3530	0,5	B9EGV	5827			BR9EIX	3981
Aletta Oro 125/S2	125	01.86 -	B9ES	2611	0,6	B9EVX	7254	202		BR9EIX	3981
Aletta,Low Rider	125	01.82 -	B8ES	2411	0,5	B8EVX	7051	201		BR8EIX	5044
Blues,C10,Cruiser	125	10.87 -	B9ES	2611	0,5	B9EVX	7254	202		BR9EIX	3981
Elefant 3	125	01.87 -	B9ES	2611	0,5	B9EVX	7254	202		BR9EIX	3981
Freccia C 9 (D)	125	06.87 -	B9ES	2611	0,6	B9EVX	7254	202		BR9EIX	3981
Freccia C10 (D)	125		B9ES	2611	0,6	B9EVX	7254	202		BR9EIX	3981
Freccia C12 (D)	125	06.87 -	B9ES	2611	0,6	B9EVX	7254	202		BR9EIX	3981
K7	125				0,5	B95EGV	2145				
Mito	125	95 - 98			0,5	B95EGV	2145				
Mito	125	99 -	BR9EG	3230	0,5	BR9EVX	1265			BR9EIX	3981
Mito 1 (D)	125				0,5	B95EGV	2145				
Mito 2 (D)	125				0,5	B95EGV	2145				
Mito EV 125	125		BR10EG	3830	0,6						
Mito Racing (D)	125				0,5	B95EGV	2145				
N 90	125	03.90 -	B9ES	2611	0,5	B9EVX	7254	202		BR9EIX	3981
Planet	125	99 - 03	BR9EG	3230	0,5	BR9EVX	1265			BR9EIX	3981
RL, SS, SX	125		B8ES	2411	0,5	B8EVX	7051	201		BR8EIX	5044



Order No.



Gold-Palladium



Platin

Order No.

Quick-No.

















Iridium







Order No.

CAGIVA

Roadster	125	98 -	BR9ES	5722	0,6	BR9EVX	1265	208	BR9EIX	3981
Aletta Rossa / Dakar	125		B9EG	3530	0,5	B9EGV	5827		BR9EIX	3981
RX 125 Rally	125	01.81 -12.81	B9EG	3530	0,5	B9EGV	5827		BR9EIX	3981
RX,WRX,WSXT	125	01.82 -12.83	B9EG	3530	0,5	B9EGV	5827		BR9EIX	3981
ST,SXT	125	01.82 -12.82	B9ES	2611	0,5	B9EVX	7254	202	BR9EIX	3981
Supercity	125	99 -	BR9EG	3230	0,5	BR9EVX	1265		BR9EIX	3981
Supercity (D)	125				0,5	B95EGV	2145			
Tamanaco 125	125	01.88 -	B9ES	2611	0,6	B9EVX	7254	202	BR9EIX	3981
W 8 11kW	125	96 - 97	B9ES	2611	0,5	B9EVX	7254	202	BR9EIX	3981
W 8	125	98 -	BR9ES	5722	0,6	BR9EVX	1265	208	BR9EIX	3981
W 8 (only D)	125	91 -			0,5	B95EGV	2145			
WMX 125/84	125				0,5	B9EVX	7254		BR9EIX	3981
WMX 125/85	125				0,5	B10EGV	5927			
WMX 125/88	125				0,5	B10EGV	5927			
WR 125	125	02 -	BR9EG	3230	0,5	BR9EVX	1265		BR9EIX	3981
WRE 125	125	02 -	BR9EG	3230	0,5	BR9EVX	1265		BR9EIX	3981
All	175		B8ES	2411	0,5	B8EVX	7051	201	BR8EIX	5044
All	200		B9ES	2611	0,5	B9EVX	7254	202	BR9EIX	3981
MX,MXR,RR,RX,WMX	250		B9ES	2611	0,5	B9EVX	7254	202	BR9EIX	3981
NC,Rt,SS,SST	250	01.83 -	B9ES	2411	0,5	B8EVX	7051	201	BR8EIX	5044
RX 250 Rally	250	01.79 -11.83	B9EG	3530	0,5	B9EGV	5827		BR9EIX	3981
SX, SXT	250	01.83 -12.84	B8ES	2411	0,5	B8EVX	7051	201	BR8EIX	5044
Ala Blu 350	350		B8ES	2411	0,5	B8EVX	7051	201	BR8EIX	5044
Ala Rossa 350/4T	350	01.83 -	B8ES	2411	0,5	B8EVX	7051	201	BR8EIX	5044
Ala Verde 350	350		B8ES	2411	0,5	B8EVX	7051	201	BR8EIX	5044
Alazzurra 350 (D)	350	01.84 -	BP7HS	5111	0,5	BP7HVX	7468		BPR7HIX	5944
Elefant 350 (D)	350		BP7HS	5111	0,5	BP7HVX	7468		BPR7HIX	5944
Lucky 350	350		DP8EA-9	5829	0,9	DPR8EVX-9	2872		DPR8EIX-9	2202
SST 350	350		B8ES	2411	0,5	B8EVX	7051	201	BR8EIX	5044
SX 350	350	11.81 -12.82	B8ES	2411	0,5	B8EVX	7051	201	BR8EIX	5044
T4 350 E, R (D)	350	10.86 -	DP8EA-9	5829	0,9	DPR8EVX-9	2872		DPR8EIX-9	2202
Trial 350	350	01.82 -	BP5ES	6511	0,6	BP5EVX	5470		BPR5EIX	6597
W12	350	94 -	DP8EA-9	5829	0,9	DPR8EVX-9	2872		DPR8EIX-9	2202
T4 500 E, R (D)	450		DP8EA-9	5829	0,9	DPR8EVX-9	2872		DPR8EIX-9	2202
Canyon 500	500	98 -	BPR8ES	3923	0,7	BPR8EVX	5573	213		
MXR 500	500				0,5	B95EGV	2145			
Canyon 600	600	98 -	BCP7ES	5030	0,8	BCP7EV	3733		BCPR7EIX	5690
Canyon 600	600	96 - 97			0,7	BKR7EVX	3544			
River 600	600	95 -			0,7	BKR7EVX	3544			
Super City	600	95 -			0,7	BKR7EVX	3544			
W16	600	94 -			0,7	BKR7EVX	3544			
Alazzurra 650 (D)	650	01.84 -	BP7HS	5111	0,6	BP7HVX	7468		BPR7HIX	5944
Elefant 650 (D)	650	01.85 -12.88	BP7HS	5111	0,6	BP7HVX	7468		BPR7HIX	5944
Raptor	650	00 -	CR8E	1275	0,7	CR8EVX	6487	226	CR8EIX	4218
V-Raptor	650	00 -	CR8E	1275	0,7	CR8EVX	6487	226	CR8EIX	4218
Elefant 750	750	94 -	DPR8EA-9	4929	0,9	DPR8EVX-9	2872	221	DPR8EIX-9	2202
Elefant 750 Lucky (D)	750	02.87 -	DPR8EA-9	4929	0,9	DPR8EVX-9	2872	221	DPR8EIX-9	2202
Elefant 900 AC (D)	900	93 -	DPR9EA-9	5329	0,9	DPR9EVX-9	3854	222	DPR9EIX-9	5545
Elefant 900 ie/GT (D)	900	92 -	DPR9EA-9	5329	0,9	DPR9EVX-9	3854	222	DPR9EIX-9	5545
Grand Canyon 900	900	98 -	DPR8EA-9	4929	0,9	DPR8EVX-9	2872	221	DPR8EIX-9	2202
Navigator 1000	1000	99 -	CR8EK	3478	0,7				CR8EIX	4218
Raptor	1000	99 -	CR8EK	3478	0,7				CR8EIX	4218

					Order No.		Gold-Palladium	Platin 	Order No.	Quick-No.	Iridium 	Order No.
CAGIVA												
V-Raptor	1000	03.00 -	CR8EK	3478	0,7						CR8EIX	4218
X-tra Raptor 1000	1000	03 -	CR8EK	3478	0,7						CR8EIX	4218
CANNONDALE												
EX 400	432	01 -	CR9EK	4548	0,7					230	CR9EIX	3521
MX 400	432	00 -	CR9EK	4548	0,7					230	CR9EIX	3521
XC 400	432	01 -	CR9EK	4548	0,7					230	CR9EIX	3521
CARABELA												
Carrera	50		BP5HS	4111	0,5							
Super SP / de Luxe	50		BP5HS	4111	0,5							
Ciclo Motor Ciao	60		B6HS	4510	0,5	B6HVX	7435	203	BR6HIX			3419
Merida, Mototic, Motopony	60		B6HS	4510	0,5	B6HVX	7435	203	BR6HIX			3419
Coyote Enduro	100		B6ES	7310	0,5	B6EVX	5136					
Coyote MX	100		B7ES	1111	0,6	B7EVX	6934					
Enduro , MX	100		B6HS	4510	0,5	B6HVX	7435	203	BR6HIX			3419
Marquesa MX	100		B8ES	2411	0,6	B8EVX	7051	201	BR8EIX			5044
Marquesa Enduro	100		B7ES	1111	0,6	B7EVX	6934					
Marquesa Mini Enduro	100		B6ES	7310	0,5	B6EVX	5136					
Marquesa Mini MX	100		B7ES	1111	0,6	B7EVX	6934					
Mini Moto	100		B6ES	7310	0,5	B6EVX	5136					
Motorcarro 100	100		B6ES	7310	0,5	B6EVX	5136					
Panthera	100		B6HS	4510	0,5	B6HVX	7435	203	BR6HIX			3419
Panthera100,Sprint 100, TS-3 100	100		B6ES	7310	0,5	B6EVX	5136					
Rally Enduro	100		B6ES	7310	0,5	B6EVX	5136					
Torero Flat Track	100		B8ES	2411	0,6	B8EVX	7051	201	BR8EIX			5044
Coyote Enduro	125		B6ES	7310	0,5	B6EVX	5136					
Coyote MX	125		B7ES	1111	0,6	B7EVX	6934					
De Luxe	125		B6ES	7310	0,5	B6EVX	5136					
Marquesa MX 111	125		B8ES	2411	0,6	B8EVX	7051	201	BR8EIX			5044
Marquesa MXV	125		B8ES	2411	0,6	B8EVX	7051	201	BR8EIX			5044
Mini Enduro	125		B6ES	7310	0,5	B6EVX	5136					
Rally Enduro	125		B6ES	7310	0,5	B6EVX	5136					
Torero Flat Track	125		B8ES	2411	0,6	B8EVX	7051	201	BR8EIX			5044
Marquesa Enduro	175		B8ES	2411	0,6	B8EVX	7051	201	BR8EIX			5044
Marquesa MK-II	175		B8ES	2411	0,6	B8EVX	7051	201	BR8EIX			5044
Rally Enduro	175		B6ES	7310	0,5	B6EVX	5136					
Strada	175		B6ES	7310	0,5	B6EVX	5136					
Torero Flat Track	175		B8ES	2411	0,6	B8EVX	7051	201	BR8EIX			5044
Enduro	200		B6ES	7310	0,5	B6EVX	5136					
Moto Cross	200		B8ES	2411	0,6	B8EVX	7051	201	BR8EIX			5044
Motorcarro Ariete	200		B6ES	7310	0,5	B6EVX	5136					
Super Turismo	200		B6ES	7310	0,5	B6EVX	5136					
Centaurio Enduro	250		B8ES	2411	0,6	B8EVX	7051	201	BR8EIX			5044
Centaurio MX-II, MX-III, MX-IV	250		B8ES	2411	0,6	B8EVX	7051	201	BR8EIX			5044
Torero Flat Track	250		B8ES	2411	0,6	B8EVX	7051	201	BR8EIX			5044
Centaurio MX-III	360		B8ES	2411	0,6	B8EVX	7051	201	BR8EIX			5044
Enduro	400		B6ES	7310	0,5	B6EVX	5136					
MX	400		B8ES	2411	0,6	B8EVX	7051	201	BR8EIX			5044
Centaurio MX-II	450		B8ES	2411	0,6	B8EVX	7051	201	BR8EIX			5044
Enduro	450		B6ES	7310	0,5	B6EVX	5136					
Torero Flat Track	450		B7ES	1111	0,6	B7EVX	6934					

					Order No.		Platin 	Order No.	Quick-No.	Iridium 	Order No.
CARREFOUR											
Web / Gap	50	00 -	B7HS	5110	0,5	B7HVX	7836	204		BR7HIX	7067
PFM	125	00 -	DR8EA	7162	0,7	DR8EVX	6354			DR8EIX	6681
CASAL											
M 105 Six Speed (RZ,Mag.)	50	92 -	B9HS	5810	0,6	B9HVX	2254				
M 109 Four Speed	50	91 -	B8HS	5510	0,6	B8HVX	2634	205		BR8HIX	7001
M 140 Automatic	50	82 -	B7HS	5110	0,6	B7HVX	7836	204		BR7HIX	7067
M 147 Two Speed	50	91 -	B7HS	5110	0,6	B7HVX	7836	204		BR7HIX	7067
M 233 Six Speed	50	90 -	B8ES	2411	0,6	B8EVX	7051	201		BR8EIX	5044
Super Boss RE	50	10.99 -	B9HS	5810	0,5	B9HVX	2254				
Super Boss K 168-8	50	91 -	B8HS	5510	0,6	B8HVX	2634	205		BR8HIX	7001
CCM											
CMX 125 L / C	125	83 - 85	B9EG	3530	0,5	B9EGV	5827			BR9EIX	3981
Moto X Hiro	125	79 - 80	B10EG	3630	0,5	B10EGV	5927				
240 CMT Trails	240		BP5ES	6511	0,7	BP5EVX	5470			BPR5EIX	6597
250 CMT Trails	250		BP5ES	6511	0,7	BP5EVX	5470			BPR5EIX	6597
250 Moto Hiro	250	79 - 81	B9EG	3530	0,5	B9EGV	5827			BR9EIX	3981
250 CMX I / C	250	83 - 85	B9EG	3530	0,5	B9EGV	5827			BR9EIX	3981
250 CMX	250	82 -	B8ES	2411	0,5	B8EVX	7051	201		BR8EIX	5044
310 CMT Trails	310		BP5ES	6511	0,7	BP5EVX	5470			BPR5EIX	6597
320 CMT Trails	320		BP5ES	6511	0,7	BP5EVX	5470			BPR5EIX	6597
350 CMT Trails	350		BP5ES	6511	0,7	BP5EVX	5470			BPR5EIX	6597
350 Trails	350	78 -	B6ES	7310	0,7	B6EVX	5136				
CM 36 Road Racer	350	78 -			0,5	B9EVX	7254			BR9EIX	3981
CMX	450	82 -			0,5	B8EVX	7051			BR8EIX	5044
490 CMX	490		B9EG	3530	0,5	B9EGV	5827			BR9EIX	3981
500 MTT	500		DR8EA	7162	0,7	DR8EVX	6354			DR8EIX	6681
CMX 500	500	82 -	DR8EA	7162	0,7	DR8EVX	6354			DR8EIX	6681
Moto X 4Ventil	500	79 - 81	R017-8	3943	0,5					CR8EIX	4218
Moto X 2Ventil	500	72 - 79	B9EG	3530	0,5	B9EGV	5827			BR9EIX	3981
560 CCM 2Takt	560		DR8EA	7162	0,7	DR8EVX	6354			DR8EIX	6681
560 CCM 4Takt	560		DR8EA	7162	0,7	DR8EVX	6354			DR8EIX	6681
604 R / RS / R30	600		DR8EA	7162	0,7	DR8EVX	6354			DR8EIX	6681
604 Supermoto dual Sport	600	01 -	DR8EA	7162	0,7	DR8EVX	6354			DR8EIX	6681
604 Roadster RS	600	01 -	DR8EA	7162	0,7	DR8EVX	6354			DR8EIX	6681
604 Trail dual Sport	600	01 -	DR8EA	7162	0,7	DR8EVX	6354			DR8EIX	6681
640 RS	640		DR8EA	7162	0,7	DR8EVX	6354			DR8EIX	6681
644	650	02 -	CR10EK	2360	0,7					CR10EIX	6482
R30 Supermotard	650	02 -	CR9EK	4548	0,7			230		CR9EIX	3521
CLIPIC											
Trial	50	00 -	B7HS	5110	0,5	B7HVX	7836	204		BR7HIX	7067
Trial E	50	00 -	B10ES	7928	0,5	B10EVX	7335			BR10EIX	6801
Trial R	80	00 -	B9ES	2611	0,5	B9EVX	7254	202		BR9EIX	3981
COSSACK											
Jupiter 350	350		BR6HS	3922	0,5			209		BR6HIX	3419
Planeta 350	350		BR6HS	3922	0,5			209		BR6HIX	3419
Dnepr 650	650		BR6HS	3922	0,5			209		BR6HIX	3419
Ural 650, Ural MT10	650		B6HS	4510	0,5	B6HVX	7435	203		BR6HIX	3419

					Order No.		Platin 	Order No.	Quick-No.	Iridium 	Order No.
CPI											
Supercross 50		50	03 -	BR7ES	5122	0,8	BR7EVX	4556			
Supermoto 50		50	03 -	BR7ES	5122	0,8	BR7EVX	4556			
CRAZY-VEHICLE											
Crazy Buggy		125	03 -	CR7HSA	4549	0,7				CR7HIX	7544
CZ											
488		125		B6HS	4510	0,6	B6HVX	7435	203	BR6HIX	3419
487		175		B6HS	4510	0,6	B6HVX	7435	203	BR6HIX	3419
485		250		B6HS	4510	0,6	B6HVX	7435	203	BR6HIX	3419
472		350		B6HS	4510	0,6	B6HVX	7435	203	BR6HIX	3419
DAELIM											
125 Daystar		125	01.00 -	C8EH-9	7473	0,9	C8EHVX-9	4450		CR8EHIX-9	3797
Altino 125 ES		125	02 -	C8EH-9	7473	0,9	C8EHVX-9	4450		CR8EHIX-9	3797
Evolution VS		125	02 -	C8EH-9	7473	0,9	C8EHVX-9	4450		CR8EHIX-9	3797
VC 125 Advance		125	95 -	C8EH-9	7473	0,9	C8EHVX-9	4450		CR8EHIX-9	3797
VJ 125 Roadwin		125	03 - 04	CR8EH-9	5666	0,9	CR8EHVX-9	4546	228	CR8EHIX-9	3797
VL 125 Daystar		125	02 -	C8EH-9	7473	0,9	C8EHVX-9	4450		CR8EHIX-9	3797
VL 125		125	00 -	CR8EH-9	5666	0,9	CR8EHVX-9	4546	228	CR8EHIX-9	3797
VL 125 L Daystar		125	02 -	C8EH-9	7473	0,9	C8EHVX-9	4450		CR8EHIX-9	3797
VS 125 EVO		125	99 -	CR8EH-9	5666	0,9	CR8EHVX-9	4546	228	CR8EHIX-9	3797
VS 125		125	97 - 98	CR8EH-9	5666	0,9	CR8EHVX-9	4546	228	CR8EHIX-9	3797
VT 125 EVO		125	00 -	CR8EH-9	5666	0,9	CR8EHVX-9	4546	228	CR8EHIX-9	3797
VT 125 Evolution		125	03.98 -	C8EH-9	7473	0,9	C8EHVX-9	4450		CR8EHIX-9	3797
DERBI											
Antorcha, Coppa, Diabolo		50	- 91	B7HS	5110	0,6	B7HVX	7836	204	BR7HIX	7067
Aventura		50	95 -	B8HS	5510	0,6	B8HVX	2634	205	BR8HIX	7001
Aventura		50	95 -	B8HS	5510	0,6	B8HVX	2634	205	BR8HIX	7001
Dirt Boy 10/10		50	03 -	CR9E	6263	0,7	CR9EVX	5943	227	CR9EIX	3521
Dirt Kid 10/12		50	03 -	CR9E	6263	0,7	CR9EVX	5943	227	CR9EIX	3521
FDS, GTS, RD-2		50	- 91	B7HS	5110	0,6	B7HVX	7836	204	BR7HIX	7067
Fenix, FDS Super, Start DS		50	92 -	B8HS	5510	0,6	B8HVX	2634	205	BR8HIX	7001
Furax		50	95 -	B8HS	5510	0,6	B8HVX	2634	205	BR8HIX	7001
GPR Replica		50	03 -	B8ES	2411	0,5	B8EVX	7051	201	BR8EIX	5044
GPR Nude 50		50		B8ES	2411	0,5	B8EVX	7051	201	BR8EIX	5044
GPR Racing		50	02 -	B8ES	2411	0,5	B8EVX	7051	201	BR8EIX	5044
GPR 50 R		50	02 -	B8ES	2411	0,5	B8EVX	7051	201	BR8EIX	5044
Hunter (D+A)		50	95 -	BP7HS	5111	0,6	BP7HVX	7468		BPR7HIX	5944
Hunter (Spain)		50	95 -	B8HS	5510	0,6	B8HVX	2634	205	BR8HIX	7001
Naked		50	04 -	B8ES	2411	0,5	B8EVX	7051	201	BR8EIX	5044
Olimpica, Savanah, Start		50	- 91	B7HS	5110	0,6	B7HVX	7836	204	BR7HIX	7067
R DRD		50	02 -	B8ES	2411	0,5	B8EVX	7051	201	BR8EIX	5044
R Racer		50	02 -	B8ES	2411	0,5	B8EVX	7051	201	BR8EIX	5044
R X-treme		50	02 -	B8ES	2411	0,5	B8EVX	7051	201	BR8EIX	5044
RD-2 Country		50	92 -	B8HS	5510	0,6	B8HVX	2634	205	BR8HIX	7001
Senda (Wasserkühlung)		50		B8ES	2411	0,5	B8EVX	7051	201	BR8EIX	5044
Sendra-R		50	95 -	B9ES	2611	0,6	B9EVX	7254	202	BR9EIX	3981
SM Black Edition		50	02 -	B8ES	2411	0,5	B8EVX	7051	201	BR8EIX	5044
SM DRD		50		B9ES	2611	0,6	B9EVX	7254	202	BR9EIX	3981
SM Racer		50	02 -	B9ES	2611	0,6	B9EVX	7254	202	BR9EIX	3981



Order No.



Gold-Palladium



Platin

Order No.

Quick-No.

















Iridium







Order No.







													DERBI	
SM X-treme	50	02 -	B9ES	2611	0,6	B9EVX	7254	202	BR9EIX			3981		
Sport, Variant, Yumbo	50	- 91	B7HS	5110	0,6	B7HVX	7836	204	BR7HIX			7067		
Urban	50	95 -	B8HS	5510	0,6	B8HVX	2634	205	BR8HIX			7001		
Vamos	50		BR8HS	4322	0,6	BR8HVX	6265	212	BR8HIX			7001		
Variant Box/Sport R / Top	50	92 -	B8HS	5510	0,6	B8HVX	2634	205	BR8HIX			7001		
Variant AIR	50	05.03 -	B8HS	5510	0,5	B8HVX	2634	205	BR8HIX			7001		
X Race 50	50		B8ES	2411	0,5	B8EVX	7051	201	BR8EIX			5044		
X Race R 50	50		B8ES	2411	0,5	B8EVX	7051	201	BR8EIX			5044		
X Treme 50	50		B8ES	2411	0,5	B8EVX	7051	201	BR8EIX			5044		
1001,Extra Sport Coppa	75		B8ES	2411	0,5	B8EVX	7051	201	BR8EIX			5044		
CR 74	75				0,5	B10EGV	5927							
Europa RD15, Scoot 74	75		B8ES	2411	0,5	B8EVX	7051	201	BR8EIX			5044		
GPR-75, Sport-75	75		B10ES	7928	0,5	B10EGV	5927		BR10EIX			6801		
Gran Prix 74	75		B6HS	4510	0,5	B6HVX	7435	203	BR6HIX			3419		
Vivo-75	75		BP5HS	4111	0,6									
BI 3	80	95 -	B8ES	2411	0,6	B8EVX	7051	201	BR8EIX			5044		
CRS, RC	125				0,5	B10EGV	5927							
Enduro, RS125TT, Karmathan	125				0,5	B9EGV	5827							
Nude GPR	125	10.04 -	BR8ES	5422	0,8	BR8EVX	1262	207	BR8EIX			5044		
Racing GPR	125	10.04 -	BR8ES	5422	0,8	BR8EVX	1262	207	BR8EIX			5044		
Senda R 125	125	02 -	DPR8EA-9	4929	0,9	DPR8EVX-9	2872	221	DPR8EIX-9			2202		
Senda SM 125	125	02 -	DPR8EA-9	4929	0,9	DPR8EVX-9	2872	221	DPR8EIX-9			2202		
Sport Coppa, TTS9	125		B9ES	2611	0,5	B9EVX	7254	202	BR9EIX			3981		
2002, Gran Prix, 6V	200		B9ES	2611	0,5	B9EVX	7254	202	BR9EIX			3981		
CRX, RC, Enduro	250				0,5	B10EGV	5927							
Turismo 250	250		B9ES	2611	0,5	B9EVX	7254	202	BR9EIX			3981		
Mulhacen	660	05 -	CR7E	4578	0,6			225	CR7EIX			7385		







													DKW	
Hummel Standard 2 Typ 113 2,0PS	48	01.59 -12.63	B7HS	5110	0,5	B7HVX	7836	204	BR7HIX			7067		
Violetta Sport Typ 158 3,1+4,2PS	48	01.60 -12.63	B8HS	5510	0,5	B8HVX	2634	205	BR8HIX			7001		
Hummel Standard 1 Typ 113 2,0PS	48	01.59 -12.63	B7HS	5110	0,5	B7HVX	7836	204	BR7HIX			7067		
Violetta Typ 128 2,0PS	48	01.60 -12.63	B7HS	5110	0,5	B7HVX	7836	204	BR7HIX			7067		
Kavalier Typ 155 3,1+4,2PS	48	01.62 -12.63	B8HS	5510	0,5	B8HVX	2634	205	BR8HIX			7001		
Kavalier Typ 115 2,0PS	48	01.62 -12.63	B7HS	5110	0,5	B7HVX	7836	204	BR7HIX			7067		
Hummel Super Typ 116 2,0PS	48	01.59 -12.63	B7HS	5110	0,5	B7HVX	7836	204	BR7HIX			7067		
Hummel Super Typ 156 3,1+4,2PS	48	01.60 -12.63	B8HS	5510	0,5	B8HVX	2634	205	BR8HIX			7001		
Hummel Super Typ 126 2,0PS	48	01.60 -12.63	B7HS	5110	0,5	B7HVX	7836	204	BR7HIX			7067		
Hummel Typ 115 2,0PS	48	01.60 -12.63	B7HS	5110	0,5	B7HVX	7836	204	BR7HIX			7067		
139 M F&S 501/4 BKF	50	10.72 -08.76	B7HS	5110	0,5	B7HVX	7836	204	BR7HIX			7067		
159 ES F&S 50 SA	50	10.72 -08.76	B6HS	4510	0,5	B6HVX	7435	203	BR6HIX			3419		
504 M F&S 504/1B	50	10.72 -08.76	B6HS	4510	0,5	B6HVX	7435	203	BR6HIX			3419		
505 P F&S 504/1A	50	10.72 -08.76	B6HS	4510	0,5	B6HVX	7435	203	BR6HIX			3419		
506 M F&S 504/1B	50	10.72 -08.76	B6HS	4510	0,5	B6HVX	7435	203	BR6HIX			3419		
510 F&S 504/1B	50	10.72 -08.76	B6HS	4510	0,5	B6HVX	7435	203	BR6HIX			3419		
530 F&S 504/1B	50	09.76 -12.83	B6HS	4510	0,5	B6HVX	7435	203	BR6HIX			3419		
532 F&S 505/1B	50	09.76 -12.83	B6HS	4510	0,5	B6HVX	7435	203	BR6HIX			3419		
533 F&S 505/2B	50	09.76 -12.83	B6HS	4510	0,5	B6HVX	7435	203	BR6HIX			3419		
534 F&S 505/1B	50	09.76 -12.83	B6HS	4510	0,5	B6HVX	7435	203	BR6HIX			3419		
535 F&S 505/2B	50	09.76 -12.83	B6HS	4510	0,5	B6HVX	7435	203	BR6HIX			3419		
630 F&S 50/2MB	50	10.72 -08.76	B7HS	5110	0,5	B7HVX	7836	204	BR7HIX			7067		
632 F&S 50/2MB	50	10.72 -08.76	B7HS	5110	0,5	B7HVX	7836	204	BR7HIX			7067		







					Order No.		Platin 	Order No.	Quick-No. 	Iridium	Order No.
DKW											
Aero 136 2,6PS	50	01.64 -12.65	B7HS	5110	0,5	B7HVX	7836	204	BR7HIX	7067	
Aero 166 5,3PS	50	01.64 -12.65	B8HS	5510	0,5	B8HVX	2634	205	BR8HIX	7001	
Hummel Standard 1 Typ 113 2,0PS	50	01.64 -12.65	B7HS	5110	0,5	B7HVX	7836	204	BR7HIX	7067	
Hummel Standard 2 Typ 113 2,0PS	50	01.64 -12.65	B7HS	5110	0,5	B7HVX	7836	204	BR7HIX	7067	
Hummel Typ 115 2,6PS	50	01.64 -12.65	B7HS	5110	0,5	B7HVX	7836	204	BR7HIX	7067	
Hummel Super Typ 136 2,6PS	50	01.64 -12.65	B7HS	5110	0,5	B7HVX	7836	204	BR7HIX	7067	
Hummel Typ 155 4,2PS	50	01.64 -12.65	B8HS	5510	0,5	B8HVX	2634	205	BR8HIX	7001	
Hummel Typ 166 5,3PS	50	01.64 -12.65	B8HS	5510	0,5	B8HVX	2634	205	BR8HIX	7001	
Violetta MK 128 2,0PS	50	01.64 -12.65	B7HS	5110	0,5	B7HVX	7836	204	BR7HIX	7067	
Jet F&S 50s	50	10.72 -08.76	B6HS	4510	0,5	B6HVX	7435	203	BR6HIX	3419	
Sportmofa F&S 505/2B	50	09.80 -12.83	B6HS	4510	0,5	B6HVX	7435	203	BR6HIX	3419	
125 E F&S 1251/6C	125	10.72 -08.76	B8HS	5510	0,5	B8HVX	2634	205	BR8HIX	7001	
RT 175	175	59 -	B7HS	5110	0,5	B7HVX	7836	204	BR7HIX	7067	
RT 250	175	59 -	B7HS	5110	0,5	B7HVX	7836	204	BR7HIX	7067	
RT 200 H	200	52 -	B6HS	4510	0,6	B6HVX	7435	203	BR6HIX	3419	
DNEPR											
Dnepr -300	649	97 -	BP5HS	4111	0,6						
11 J Gespann 28KW	650		BP6HS	4511	0,6	BP6HVX	4635		BPR6HIX	4085	
16 J Gespann 28KW	650		BP6HS	4511	0,6	BP6HVX	4635		BPR6HIX	4085	
KM3-8.157	650		BP6ES	7811	0,7	BP6EVX	5832		BPR6EIX	6637	
KM3-8.157-022	650		BP6ES	7811	0,7	BP6EVX	5832		BPR6EIX	6637	
MT 11 20KW	650		BP6HS	4511	0,6	BP6HVX	4635		BPR6HIX	4085	
MT 16 20KW	650		BP6HS	4511	0,6	BP6HVX	4635		BPR6HIX	4085	
DUCATI											
100 Sport	100	58 - 60	B7HS	5110	0,6	B7HVX	7836	204	BR7HIX	7067	
125 Scrambler	125	71 -	B8HS	5510	0,5	B8HVX	2634	205	BR8HIX	7001	
125 Sport	125	58 - 65	B7HS	5110	0,6	B7HVX	7836	204	BR7HIX	7067	
125 TS	125	59 - 65	B6HS	4510	0,5	B6HVX	7435	203	BR6HIX	3419	
160 Monza	160		B7HS	5110	0,6	B7HVX	7836	204	BR7HIX	7067	
175 Sport	175	58 - 61	B7HS	5110	0,6	B7HVX	7836	204	BR7HIX	7067	
175 TS	175	58 - 60	B6HS	4510	0,5	B6HVX	7435	203	BR6HIX	3419	
200 Elite	200	59 - 65	B7HS	5110	0,6	B7HVX	7836	204	BR7HIX	7067	
250 Mach 1	250	64 - 66	B7HS	5110	0,6	B7HVX	7836	204	BR7HIX	7067	
250 Monza	250	68 -	B7HS	5110	0,6	B7HVX	7836	204	BR7HIX	7067	
250 SCR	250	68 - 74	B7HS	5110	0,6	B7HVX	7836	204	BR7HIX	7067	
250 SCR-MC	250	62 - 67	B7HS	5110	0,6	B7HVX	7836	204	BR7HIX	7067	
350 Desmo	350	70 - 76	B6HS	4510	0,5	B6HVX	7435	203	BR6HIX	3419	
350 F3	350	86 - 87	B6HS	4510	0,5	B6HVX	7435	203	BR6HIX	3419	
350 F3 Desmo	350		BP7HS	5111	0,5	BP7HVX	7468		BPR7HIX	5944	
350 Forza	350		B6HS	4510	0,5	B6HVX	7435	203	BR6HIX	3419	
350 GTL	350	79 -	B6HS	4510	0,5	B6HVX	7435	203	BR6HIX	3419	
350 Indiana	350	86 -	BR7HS	4122	0,5			211	BR7HIX	7067	
350 Junior	350	92 -	BP7HS	5111	0,6	BP7HVX	7468		BPR7HIX	5944	
350 MK III	350	70 - 76	B6HS	4510	0,5	B6HVX	7435	203	BR6HIX	3419	
350 MK III D	350		B6HS	4510	0,5	B6HVX	7435	203	BR6HIX	3419	
350 Sebring	350	65 - 68	B7HS	5110	0,6	B7HVX	7836	204	BR7HIX	7067	
350 Sport	350	92 -	BP5ES	6511	0,7	BP5EVX	5470		BPR5EIX	6597	
350 Sport Desmo	350		BR7HS	4122	0,5			211	BR7HIX	7067	
350 Vento	350	80 -	B6HS	4510	0,5	B6HVX	7435	203	BR6HIX	3419	
XL 350	350		BPR7HS	6422	0,6	BPR7HVX	2938	215	BPR7HIX	5944	







					Order No.		Platin 	Order No.	Quick-No.	Iridium 	Order No.
DUCATI											
400 Supersport Junior (D)	400	91 -	BPR7HS	6422	0,6	BPR7HVX	2938	215	BPR7HIX	5944	
Monster 400	400	03 -	DCPR8E	4339	0,9	DCPR8EVX	2265		DCPR8EIX	6546	
450 / Scrambler (D)	450	70 - 76	B6HS	4510	0,5	B6HVX	7435	203	BR6HIX	3419	
450 Desmo Sport	450	71 - 74	BR7HS	4122	0,5			211	BR7HIX	7067	
450 Mark 3D	450	69 - 71	BR7HS	4122	0,5			211	BR7HIX	7067	
450 R/T	450	71 - 72	BR7HS	4122	0,5			211	BR7HIX	7067	
450 SCR	450	69 - 74	B7HS	5110	0,6	B7HVX	7836	204	BR7HIX	7067	
450 T/S	450	71 - 73	BR7HS	4122	0,5			211	BR7HIX	7067	
500 GTL	500	74 - 79	B7HS	5110	0,5	B7HVX	7836	204	BR7HIX	7067	
500 Pantah (D)	500	80 -	B7HS	5110	0,5	B7HVX	7836	204	BR7HIX	7067	
500 SL Pantah (D)	500		BPR7HS	6422	0,6	BPR7HVX	2938	215	BPR7HIX	5944	
500 Sport Desmo	500	79 - 83	B6HS	4510	0,5	B6HVX	7435	203	BR6HIX	3419	
500 Sport Twin	500	78 -	B7HS	5110	0,5	B7HVX	7836	204	BR7HIX	7067	
600 Monster	600	94 - 96	DCPR8E	4339	0,9	DCPR8EVX	2265		DCPR8EIX	6546	
600 Pantah SL/TL (D)	600	81 -	BPR7HS	6422	0,6	BPR7HVX	2938	215	BPR7HIX	5944	
600 SS	600	94 -	DCPR8E	4339	0,9	DCPR8EVX	2265		DCPR8EIX	6546	
M 600 Monster all models	600	97 -	DCPR8E	4339	0,9	DCPR8EVX	2265		DCPR8EIX	6546	
620 i.e. Dark	620	02 -	DPR8EA-9	4929	0,9	DPR8EVX-9	2872	221	DPR8EIX-9	2202	
620 S i.e.	620	02 -	DPR8EA-9	4929	0,9	DPR8EVX-9	2872	221	DPR8EIX-9	2202	
M 620 i.e	620	01 -	DPR8EA-9	4929	0,9	DPR8EVX-9	2872	221	DPR8EIX-9	2202	
Multistrada	620	05 -	DCPR8E	4339	0,9	DCPR8EVX	2265		DCPR8EIX	6546	
M 620S i.e	620	01 -	DPR8EA-9	4929	0,9	DPR8EVX-9	2872	221	DPR8EIX-9	2202	
620 Sport	620	03 -	DCPR8E	4339	0,9	DCPR8EVX	2265		DCPR8EIX	6546	
620 i.e.	620	02 -	DPR8EA-9	4929	0,9	DPR8EVX-9	2872	221	DPR8EIX-9	2202	
650 Indiana	650	87 -	BP7HS	5111	0,6	BP7HVX	7468		BPR7HIX	5944	
748 / SP/ SPS	748	95 -			0,6	DCPR9EVX	6436				
748 / Biposto	748	99 -			0,6	DCPR9EVX	6436				
748 S	748				0,6	DCPR9EVX	6436				
748 R	748		R2270-9	4319							
749 S 76kW	748	03 -	---			---			---		
749 R	750	04 -	---			---			---		
750 SS Königswelle	750	72 - 83	BPR7HS	6422	0,6	BPR7HVX	2938	215	BPR7HIX	5944	
750 GT	750	74 - 76	BPR7HS	6422	0,6	BPR7HVX	2938	215	BPR7HIX	5944	
750 F1 Desmo	750	88 -	DCPR8E	4339	0,9	DCPR8EVX	2265		DCPR8EIX	6546	
750 Monster	750	96 - 97	DCPR8E	4339	0,9	DCPR8EVX	2265		DCPR8EIX	6546	
750 Indiana (D)	750	87 -	BPR7HS	6422	0,6	BPR7HVX	2938	215	BPR7HIX	5944	
750 SS	750	91 -			0,6	DCPR9EVX	6436				
750 Paso (D)	750	86 -	DCPR8E	4339	0,9	DCPR8EVX	2265		DCPR8EIX	6546	
750 F1/LS (D)	750	85 -	DCPR8E	4339	0,9	DCPR8EVX	2265		DCPR8EIX	6546	
750 Sport (D)	750	88 - 90	BPR7HS	6422	0,6	BPR7HVX	2938	215	BPR7HIX	5944	
SS 750 HF I.E.	750				0,6	DCPR9EVX	6436				
SS 750 I.E.	750				0,6	DCPR9EVX	6436				
750 SS i.e.	750	99 -	DPR8EA-9	4929	0,9	DPR8EVX-9	2872	221	DPR8EIX-9	2202	
M 750 Monster all models	750	97 -	DCPR8E	4339	0,9	DCPR8EVX	2265		DCPR8EIX	6546	
800 Sport	800	03 -	DCPR8E	4339	0,9	DCPR8EVX	2265		DCPR8EIX	6546	
Monster 800 i.e.	800	03 -	DCPR8E	4339	0,9	DCPR8EVX	2265		DCPR8EIX	6546	
800 SuperSport	800	03 -	DCPR8E	4339	0,9	DCPR8EVX	2265		DCPR8EIX	6546	
Monster S2R	803	05 -	DCPR8E	4339	0,9	DCPR8EVX	2265		DCPR8EIX	6546	
851 S1 (D)	851	88 - 88			0,6	D9EVX	2834		DR9EIX	4772	
851 S3 (D)	851	89 - 92			0,6	D9EVX	2834		DR9EIX	4772	
860 GT,GTS,S (D)	860	75 -	B6HS	4510	0,5	B6HVX	7435	203	BR6HIX	3419	
860 Desmo SS (D)	860		B6HS	4510	0,5	B6HVX	7435	203	BR6HIX	3419	







					Order No.		Platin 	Order No.	Quick-No.	Iridium 	Order No.
DUCATI											
888 Strada	888	93 -			0,6	DCPR9EVX	6436				
888 SP5	888	93 -	R2270-9	4319	0,5						
851 S.P.,II,III,IV	888				0,6	D9EVX	2834			DR9EIX	4772
900 Super Sport (D)	900	88 - 90	DCPR8E	4339	0,9	DCPR8EVX	2265			DCPR8EIX	6546
900 S,SS,GTS,SD,S2,HR (D)	900	80 -	BP7HS	5111	0,6	BP7HVX	7468			BPR7HIX	5944
907 I.E.	900	91 -	DCPR8E	4339	0,9	DCPR8EVX	2265			DCPR8EIX	6546
M 900 Monster all models	900	97 -	DCPR8E	4339	0,9	DCPR8EVX	2265			DCPR8EIX	6546
Super Sport 900	900	91 - 92	DCPR8E	4339	0,9	DCPR8EVX	2265			DCPR8EIX	6546
Darmah 900 (D)	900		B6HS	4510	0,6	B6HVX	7435	203		BR6HIX	3419
Paso 906	900	88 - 90	DCPR8E	4339	0,9	DCPR8EVX	2265			DCPR8EIX	6546
900 SS / SL	900	91 - 98	DCPR8E	4339	0,9	DCPR8EVX	2265			DCPR8EIX	6546
M 900 I.E.	900	99 -	DCPR8E	4339	0,9	DCPR8EVX	2265			DCPR8EIX	6546
MH 900 EVOLUZIONE (75PS)	900	00 -	DPR8EA-9	4929	0,9	DPR8EVX-9	2872	221		DPR8EIX-9	2202
Monster 900 Spezial (57kW)	900	00 -	DPR8EA-9	4929	0,9	DPR8EVX-9	2872	221		DPR8EIX-9	2202
900 SS final edition	900	99 - 03	DPR8EA-9	4929	0,9	DPR8EVX-9	2872	221		DPR8EIX-9	2202
900 SS I.E.	904	91 - 98	DCPR8E	4339	0,9	DCPR8EVX	2265			DCPR8EIX	6546
916 (non SP model)	916	94 -			---						
S 4	916	01 -	---		---						
S T 4	916	98 -			---						
S T 2	944	97 -	DCPR8E	4339	0,9	DCPR8EVX	2265			DCPR8EIX	6546
Mille (D)	972		BP7HS	5111	0,6	BP7HVX	7468			BPR7HIX	5944
916 SP / SPS	996	98 -	R2349-9	4418	0,5						
996 Biposto	996	99 -			0,6	DCPR9EVX	6436				
996 SP / SPS	996	98 -	R2349-9	4418	0,5						
S 4 R Monster	996	04 -			0,6	DCPR9EVX	6436				
S T 4 s	996				0,6	DCPR9EVX	6436				
996 R 99kW (H2)	998		---		---					---	
998 S (H2)	998	02 -	---		---					---	
998	998	01 -	---		---					---	
998 (H2)	998	02 -	---		---					---	
998 R (H2)	998	02 -	---		---					---	
999 R	998	09.02 -	---		---					---	
999 S 100kW	998	03 -	---		---					---	
999	998	05 -			0,6	DCPR9EVX	6436				
1000 S2,HR	1000	85 -	BPR7HS	6422	0,6	BPR7HVX	2938	215		BPR7HIX	5944
ST 3	1000	04 -			0,6	CR9EVX	5943			CR9EIX	3521
Multistrada 1000	1000	02 -	DPR8EA-9	4929	0,9	DPR8EVX-9	2872	221		DPR8EIX-9	2202
1000 SuperSport	1000	03 -	DCPR8E	4339	0,9	DCPR8EVX	2265			DCPR8EIX	6546
1000 DS	1000	03 -	DCPR8E	4339	0,9	DCPR8EVX	2265			DCPR8EIX	6546
Monster 1000 i.e.	1000	03 -	DCPR8E	4339	0,9	DCPR8EVX	2265			DCPR8EIX	6546
Multistrada 1000 / S / DS	1000	05 -	DPR8EA-9	4929	0,9	DPR8EVX-9	2872	221		DPR8EIX-9	2202
S2R 1000 Monster	1000	06 -	DCPR8E	4339	0,9	DCPR8EVX	2265			DCPR8EIX	6546
Classic Sport 1000	1000	06 -	DCPR8E	4339	0,9	DCPR8EVX	2265			DCPR8EIX	6546
Paul Smart 1000	1000	06 -	DCPR8E	4339	0,9	DCPR8EVX	2265			DCPR8EIX	6546
DUCSON											
Automatic 49	50		B6HS	4510	0,5	B6HVX	7435	203		BR6HIX	3419
S21TT,S30TT,XL50 Mercury	50		B6HS	4510	0,5	B6HVX	7435	203		BR6HIX	3419
S9,S15,S16,S20TT	50		B6HS	4510	0,5	B6HVX	7435	203		BR6HIX	3419
DÜRRKOPP											
Diana			B7HS	5110	0,5	B7HVX	7836	204		BR7HIX	7067







					Order No.		Gold-Palladium	Platin 	Order No.	Quick-No.	Iridium 	Order No.
DÜRRKOPP												
Moped 47	47		B6HS	4510	0,5	B6HVX	7435	203	BR6HIX	3419		
MD 150	150		B7HS	5110	0,5	B7HVX	7836	204	BR7HIX	7067		
Diana TS	175		B8HS	5510	0,5	B8HVX	2634	205	BR8HIX	7001		
MD 175	175		B7HS	5110	0,5	B7HVX	7836	204	BR7HIX	7067		
MD 200	200		B7HS	5110	0,5	B7HVX	7836	204	BR7HIX	7067		
MD 201	200		B7HS	5110	0,5	B7HVX	7836	204	BR7HIX	7067		
EATV												
Evolution 510	510		DCPR8E	4179	0,6	DCPR8EVX	2265		DCPR8EIX	6546		
Explorer 625	625		DPR8EA-9	4929	0,9	DPR8EVX-9	2872	221	DPR8EIX-9	2202		
Extreme 950	950		CR8EK	3478	0,7				CR8EIX	4218		
Energie 992	1000		DCPR8E	4179	0,6	DCPR8EVX	2265		DCPR8EIX	6546		
ERING												
AT 50 pt 2	50		B6HS	4510	0,6	B6HVX	7435	203	BR6HIX	3419		
RT 50	50		B6HS	4510	0,6	B6HVX	7435	203	BR6HIX	3419		
FANTIC												
Issimo Convert/Kick	50		B5HS	4210	0,5							
Junior,Tender To	50		B5HS	4210	0,5							
Trial 50	50		B7HS	5110	0,5	B7HVX	7836	204	BR7HIX	7067		
Caballero 80	75		B9HS	5810	0,5	B9HVX	2254					
Trial 75	75		B8HS	5510	0,5	B8HVX	2634	205	BR8HIX	7001		
Caballero	80		B8EG	3430	0,5	B8EGV	5627					
Enduro	80		B8EG	3430	0,5	B8EGV	5627					
RSX 80	80		B8EG	3430	0,5	B8EGV	5627					
Caballero	125		B9EG	3530	0,5	B9EGV	5827		BR9EIX	3981		
Cross	125		B9EG	3530	0,5	B9EGV	5827		BR9EIX	3981		
Professional	125		B6HS	4510	0,5	B6HVX	7435	203	BR6HIX	3419		
RSX 125	125		B9EG	3530	0,5	B9EGV	5827		BR9EIX	3981		
Trial 125	125		B6HS	4510	0,5	B6HVX	7435	203	BR6HIX	3419		
Trial / Competicion	125		B7HS	5110	0,5	B7HVX	7836	204	BR7HIX	7067		
Trial 200	160		BP7HS	5111	0,5	BP7HVX	7468		BPR7HIX	5944		
TX 160	160		B8EG	3430	0,5	B8EGV	5627					
Enduro	175		B8EG	3430	0,5	B8EGV	5627					
Trial 200	200		B6HS	4510	0,5	B6HVX	7435	203	BR6HIX	3419		
Trial 240	240		B6HS	4510	0,5	B6HVX	7435	203	BR6HIX	3419		
Section	250	95 - 97	BCP7ES	5030	0,5	BCP7EV	3733		BCPR7EIX	5690		
Trial 301 Competicion	250		BP5ES	6511	0,5	BP5EVX	5470		BPR5EIX	6597		
Trial 301/305/307	250		B8ES	2411	0,5	B8EVX	7051	201	BR8EIX	5044		
Trial Coach	250		B8ES	2411	0,5	B8EVX	7051	201	BR8EIX	5044		
Trial K-Roo	250		B8ES	2411	0,5	B8EVX	7051	201	BR8EIX	5044		
TX 250	250		B8EG	3430	0,5	B8EGV	5627					
TX 260	260		B8EG	3430	0,5	B8EGV	5627					
Professional	300		B8EG	3430	0,5	B8EGV	5627					
TX 330	330		B8EG	3430	0,5	B8EGV	5627					
FITE (LEM)												
Champion H-Y, Sandy 4M	50		B8HS	5510	0,6	B8HVX	2634	205	BR8HIX	7001		
Cross CR-2, Safari BX	50		B8HS	5510	0,6	B8HVX	2634	205	BR8HIX	7001		
Cross CR-3,Small,Safari BX	50		B6HS	4510	0,6	B6HVX	7435	203	BR6HIX	3419		







					Order No.		Platin 	Order No.	Quick-No. 	Iridium	Order No.
G.A.C. MobyLe.											
87//89/188/188E/188TC			- 87	B6HS	4510	0,5	B6HVX	7435	203	BR6HIX	3419
AV49R/51/69/70/70E/72/83R				B6HS	4510	0,5	B6HVX	7435	203	BR6HIX	3419
AV87,AV90,D55,			88 -	B7HS	5110	0,5	B7HVX	7836	204	BR7HIX	7067
Cady/E14,Campera			- 87	B6HS	4510	0,5	B6HVX	7435	203	BR6HIX	3419
Campera,Coma First			88 -	B7HS	5110	0,5	B7HVX	7836	204	BR7HIX	7067
D55/E/77/Cross,SP50			- 87	B6HS	4510	0,5	B6HVX	7435	203	BR6HIX	3419
D55NTT,SP95R,Cady			88 -	B7HS	5110	0,5	B7HVX	7836	204	BR7HIX	7067
Hawar,Chopper,Cross NTT,				B7HS	5110	0,5	B7HVX	7836	204	BR7HIX	7067
Kanwey,Onix,			88 -	B7HS	5110	0,5	B7HVX	7836	204	BR7HIX	7067
Liberty,Moby Cross,				B6HS	4510	0,5	B6HVX	7435	203	BR6HIX	3419
MTR Top Racing,Winner				B8ES	2411	0,5	B8EVX	7051	201	BR8EIX	5044
Onix 2/City/Coma,Rural				B7HS	5110	0,5	B7HVX	7836	204	BR7HIX	7067
Onix ,Stylo GT,			- 87	B6HS	4510	0,5	B6HVX	7435	203	BR6HIX	3419
SP90/90R/94/95R /96			- 87	B6HS	4510	0,5	B6HVX	7435	203	BR6HIX	3419
Transport ,University			- 87	B6HS	4510	0,5	B6HVX	7435	203	BR6HIX	3419
Transporter ,Zarpa NTT			88 -	B7HS	5110	0,5	B7HVX	7836	204	BR7HIX	7067
G+G											
Cruso	1200		03 -	BKR7EKC	7354					BKR7EIX	2667
Cruso S	1200		03 -	BKR7EKC	7354					BKR7EIX	2667
GARELLI											
Bonanza	25			B6HS	4510	0,6	B6HVX	7435	203	BR6HIX	3419
Bimatic,ES,Gary Uno	50			B6HS	4510	0,5	B6HVX	7435	203	BR6HIX	3419
Formuno,Noi Matic,TL,2V	50			B6HS	4510	0,5	B6HVX	7435	203	BR6HIX	3419
Noi Bimatic,TL,ES,Team Mat	50			B6HS	4510	0,5	B6HVX	7435	203	BR6HIX	3419
Sahel 80	75			B9ES	2611	0,5	B9EVX	7254	202	BR9EIX	3981
GTA 125/ES	125			B10ES	7928	0,5	B10EGV	5927		BR10EIX	6801
Tiger 125 XLE	125			B10ES	7928	0,5	B10EGV	5927		BR10EIX	6801
323 Trail	320			BP5ES	6511	0,5	BP5EVX	5470		BPR5EIX	6597
GAS GAS											
Contact, Enducross	50			B8HS	5510	0,6	B8HVX	2634	205	BR8HIX	7001
ec boy 50	50		00 -	B8HS	5510	0,5	B8HVX	2634	205	BR8HIX	7001
ec rookie 50	50		00 -	BR9ES	5722	0,6	BR9EVX	1265	208	BR9EIX	3981
Endurocross BOY	50			BPR5ES	7422	0,6	BPR5EVX	4875		BPR5EIX	6597
TXT BOY	50			BPR5ES	7422	0,6	BPR5EVX	4875		BPR5EIX	6597
TXT boy 50 (Alukopf)(aluhead)	50		04 -	BR8ECM	3035	0,6	BR8ECMVX	5567			
Contact T 12	125		94 -	BP5ES	6511	0,5	BP5EVX	5470		BPR5EIX	6597
Cross TT 125	125					0,5	B10EGV	5927			
ec 125	125		97 -	B9EG	3530	0,6	B9EGV	5827		BR9EIX	3981
Enducross TT 125	125					0,5	B10EGV	5927			
125 Enduro	125		02 -	BR8EG	3130	0,6					
Pampera 125	125			BPR6ES	7822	0,8	BPR6EVX	6764		BPR6EIX	6637
Trial 125	125			BP5ES	6511	0,5	BP5EVX	5470		BPR5EIX	6597
TT 125	125			BR8EG	3130	0,6					
TXT 125	125		99 -	BPR5ES	7422	0,6	BPR5EVX	4875		BPR5EIX	6597
Contact T 16	143		94 -	BP5ES	6511	0,5	BP5EVX	5470		BPR5EIX	6597
ec 200	200		99 -	B10EGV	5927	0,6	B10EVX	7335			
200 Enduro	200		02 -	BR8EG	3130	0,6					
Pampera 200	200			BPR6ES	7822	0,8	BPR6EVX	6764		BPR6EIX	6637
TT 200	200			BR8EG	3130	0,6					









					Order No.		Gold-Palladium		Order No.	Quick-No.		Iridium	Order No.
GAS GAS													
TXT 200	200	99 -	BPR5ES	7422	0,6	BPR5EVX	4875				BPR5EIX	6597	
Contact JT 25	238	94 -	BP5ES	6511	0,5	BP5EVX	5470				BPR5EIX	6597	
TXT 249	249	99 -	BPR5ES	7422	0,6	BPR5EVX	4875				BPR5EIX	6597	
250 MC	250	04 -	BR8EG	3130	0,6								
Cross 250	250		BR8EG	3130	0,6								
Delta 25 GT	250		BP5ES	6511	0,5	BP5EVX	5470				BPR5EIX	6597	
ec 250	250	97 -	B8EG	3430	0,5	B8EGV	5627						
Enducross 250	250				0,5	B10EGV	5927						
250 Enduro	250	02 -	BR8EG	3130	0,6								
Pampera 250	250		BPR6ES	7822	0,8	BPR6EVX	6764				BPR6EIX	6637	
Piri-A 6 Magnum	250		BP5ES	6511	0,5	BP5EVX	5470				BPR5EIX	6597	
Trial 250 (water + air)	250		BP5ES	6511	0,5	BP5EVX	5470				BPR5EIX	6597	
TT 250	250		BR8EG	3130	0,6								
TXT 250	250		BPR5ES	7422	0,6	BPR5EVX	4875				BPR5EIX	6597	
TXT 280	272	00 -	BP5ES	6511	0,5	BP5EVX	5470				BPR5EIX	6597	
TXT 280	280		BPR5ES	7422	0,6	BPR5EVX	4875				BPR5EIX	6597	
ec 300	300	99 -	B10EGV	5927	0,6	B10EVX	7335						
300 Enduro	300	02 -	BR8EG	3130	0,6								
TT 300	300		BR8EG	3130	0,6								
Pampera 320	320		BPR6ES	7822	0,8	BPR6EVX	6764				BPR6EIX	6637	
TXT 321	321	99 -	BPR5ES	7422	0,6	BPR5EVX	4875				BPR5EIX	6597	
Delta 32 GT	330		BP5ES	6511	0,5	BP5EVX	5470				BPR5EIX	6597	
Trial 327	330		BP5ES	6511	0,5	BP5EVX	5470				BPR5EIX	6597	
Trial Halley PXC 325	330		B9ES	2611	0,5	B9EVX	7254	202			BR9EIX	3981	
FSE 400	400	02 -	CR8E	1275	0,7	CR8EVX	6487	226			CR8EIX	4218	
Normada 500	500		D8EA	2120	0,5	D8EVX	2850	216			DR8EIX	6681	
GILERA													
50 TS	50	01.79 -12.82	B7ES	1111	0,5	B7EVX	6934						
CB1 4V	50		B6ES	7310	0,5	B6EVX	5136						
CBA, SS, SSV	50		B6HS	4510	0,5	B6HVX	7435	203			BR6HIX	3419	
DNA 50	50	01 -	BR9ES	5722	0,6	BR9EVX	1265	208			BR9EIX	3981	
Eaglet	50		B9ES	2611	0,5	B9EVX	7254	202			BR9EIX	3981	
EC 1	50	92 -	B5HS	4210	0,5								
ECO	50	01.79 -	B6HS	4510	0,5	B6HVX	7435	203			BR6HIX	3419	
GR 2	50	01.77 -12.82	B6ES	7310	0,5	B6EVX	5136						
GR 2 (Export)	50		B7ES	1111	0,5	B7EVX	6934						
Grande	50		B6HS	4510	0,5	B6HVX	7435	203			BR6HIX	3419	
GSA	50	03.82 -	B6HS	4510	0,5	B6HVX	7435	203			BR6HIX	3419	
GSM	50	01 -	BR9ES	5722	0,6	BR9EVX	1265	208			BR9EIX	3981	
RS	50	01.75 -07.80	B6ES	7310	0,5	B6EVX	5136						
Storm	50	94 -	B9ES	2611	0,5	B9EVX	7254	202			BR9EIX	3981	
Super RE, RL	50		B6ES	7310	0,5	B6EVX	5136						
Touring	50	01.73 -12.81	B7ES	1111	0,5	B7EVX	6934						
Trend 50	50		B5HS	4210	0,6								
Trial	50		B7ES	1111	0,5	B7EVX	6934						
TS	50	01.79 -12.82	B6ES	7310	0,5	B6EVX	5136						
80 TG 2, 3	80	03.82 -12.82	B9ES	2611	0,5	B9EVX	7254	202			BR9EIX	3981	
Jubilee	90		B7ES	1111	0,5	B7EVX	6934						
Giubileo 4 T, SS	98		B8ES	2411	0,5	B8EVX	7051	201			BR8EIX	5044	
125 5V Regolarità	125				0,5	B10EGV	5927						
125 Arcore, Export	125	01.72 -06.80	B8ES	2411	0,5	B8EVX	7051	201			BR8EIX	5044	

					Order No.		Platin 	Order No.	Quick-No. 	Iridium	Order No.
GILERA											
125 C1		125				0,5	B105EGV	2171			
125 C3		125				0,5	B10EGV	5927			
125 Cross Competition		125				0,5	B105EGV	2171			
125 E1		125				0,5	B105EGV	2171			
125 Endurance		125		B9ES	2611	0,5	B9EVX	7254	202	BR9EIX	3981
125 Enduro		125				0,5	B105EGV	2171			
125 ER		125	12.87 - 03.88	B9ES	2611	0,5	B9EVX	7254	202	BR9EIX	3981
125 GR1		125	01.76 - 03.81	B7ES	1111	0,5	B7EVX	6934			
125 Hawk		125	11.85 - 12.86	B9ES	2611	0,5	B9EVX	7254	202	BR9EIX	3981
125 RTT Nebraska		125	02.86 - 03.88	B9ES	2611	0,5	B9EVX	7254	202	BR9EIX	3981
125 SV Regolarità		125				0,5	B95EGV	2145			
125 TG1		125	01.76 - 12.81	B7ES	1111	0,5	B7EVX	6934			
125 TG2		125	12.81 - 12.83	B8ES	2411	0,5	B8EVX	7051	201	BR8EIX	5044
125 TG3		125	12.81 - 12.83	B8ES	2411	0,5	B8EVX	7051	201	BR8EIX	5044
Arizona		125		B9EG	3530	0,5	B9EGV	5827		BR9EIX	3981
Coguar		125		DPR8EA-9	4929	0,9	DPR8EVX-9	2872	221	DPR8EIX-9	2202
DNA 125		125	01 -	CR9EB	6955	0,6				CR9EIX	3521
E1 Competition		125				0,5	B105EGV	2171			
Fast Bike 125		125	02.87 - 12.88	B9ES	2611	0,5	B9EVX	7254	202	BR9EIX	3981
HX 125		125				0,5	B10EGV	5927			
KK 125		125	09.86 - 12.87	B9ES	2611	0,5	B9EVX	7254	202	BR9EIX	3981
KZ 125		125	03.86 - 12.89	B9ES	2611	0,5	B9EVX	7254	202	BR9EIX	3981
R1 S		125	09.89 -	B9EG	3530	0,5	B9EGV	5827		BR9EIX	3981
RC 125 Rally		125		B9ES	2611	0,5	B9EVX	7254	202	BR9EIX	3981
RTX		125	02.86 - 12.86	B9EG	3530	0,5	B9EGV	5827		BR9EIX	3981
RV 125		125	05.84 - 12.86	B9EG	3530	0,5	B9EGV	5827		BR9EIX	3981
RX 125		125	01.84 - 06.85	B9EG	3530	0,5	B9EGV	5827		BR9EIX	3981
Top Rally RC		125	09.90 -	B10EGV	3630	0,5	B10EGV	5927			
XR 2		125	01.89 -	B9EG	3530	0,5	B9EGV	5827		BR9EIX	3981
XRI 125		125		B9EG	3530	0,5	B9EGV	5827		BR9EIX	3981
150 Arcore, Export		150	01.72 - 06.80	B8ES	2411	0,5	B8EVX	7051	201	BR8EIX	5044
DNA 180		180	01 -	CR9EB	6955	0,6				CR9EIX	3521
200 T4		200	09.82 - 06.84	B8ES	2411	0,5	B8EVX	7051	201	BR8EIX	5044
Arizona		200	11.85 - 12.86	B9EG	3530	0,5	B9EGV	5827		BR9EIX	3981
RTX		200	02.86 - 12.86	B9EG	3530	0,5	B9EGV	5827		BR9EIX	3981
RV 200 LC		200	01.85 - 12.86	B9EG	3530	0,5	B9EGV	5827		BR9EIX	3981
RX 200 LC		200	01.85 - 12.86	B9EG	3530	0,5	B9EGV	5827		BR9EIX	3981
250 Arizona Rally		250	11.85 - 12.86	B9ES	2611	0,5	B9EVX	7254	202	BR9EIX	3981
250 C3		250				0,5	B105EGV	2171			
250 KK, KZ		250		B9ES	2611	0,5	B9EVX	7254	202	BR9EIX	3981
250 NGR		250	05.85 - 12.86	B9ES	2611	0,5	B9EVX	7254	202	BR9EIX	3981
HX 250		250				0,5	B105EGV	2171			
NX 250 LC		250				0,5	B105EGV	2171			
RV 250 NGR		250		B9ES	2611	0,5	B9EVX	7254	202	BR9EIX	3981
Dakota 350		350		DP9EA-9	6629	0,9	DP9EVX-9	3331		DPR9EIX-9	5545
Dakota 350 ER		350		DP9EA-9	6629	0,9	DP9EVX-9	3331		DPR9EIX-9	5545
XRT 350		350	05.88 -	DP9EA-9	6629	0,9	DP9EVX-9	3331		DPR9EIX-9	5545
Dakota 500		500	04.87 -	DP9EA-9	6629	0,9	DP9EVX-9	3331		DPR9EIX-9	5545
Saturno 500		500	04.88 - 92	DP9EA-9	6629	0,9	DP9EVX-9	3331		DPR9EIX-9	5545
XRT 600		550	05.88 - 92	DP9EA-9	6629	0,9	DP9EVX-9	3331		DPR9EIX-9	5545
600 FB (Nordcape)		600	92 -	D8EA	2120	0,5	D8EVX	2850	216	DR8EIX	6681
Nordwest 600		600		DCPR9E	2641	0,7	DCPR9EVX	6436		DCPR9EIX	2316

					Order No.		Gold-Palladium	Platin 	Order No.	Quick-No.	Iridium 	Order No.
GILERA												
RC 600	600	-	92	D8EA	2120	0,5	D8EVX	2850	216	DR8EIX	6681	
RC 600 C	600	92 -		D8EA	2120	0,5	D8EVX	2850	216	DR8EIX	6681	
GIMSON												
Cantigo TT,Cross,Jumper	50			B5HS	4210	0,5						
Elite Sport/Super/E2/E87,	50			B5HS	4210	0,5						
Nevada/AL,Maxi Automatico	50			B5HS	4210	0,5						
Polaris,Shipper Trial,	50			B5HS	4210	0,5						
Variomatic,LSA,LSA-RA	50			B5HS	4210	0,5						
GOERICKE												
300 Ilo MM525	50	10.70 -01.73		A7	1110							
301 AM / B F&S 50/AMB, 50/2MB	50	12.66 -12.75		B7HS	5110	0,5	B7HVX	7836	204	BR7HIX	7067	
HARLEY-DAVIDSON												
M50	50			B8ES	2411	0,5	B8EVX	7051	201	BR8EIX	5044	
M50S	50			B8ES	2411	0,5	B8EVX	7051	201	BR8EIX	5044	
M65	65			BP5ES	6511	0,6	BP5EVX	5470		BPR5EIX	6597	
M65S	65			BP5ES	6511	0,6	BP5EVX	5470		BPR5EIX	6597	
MC65	65			BP5ES	6511	0,6	BP5EVX	5470		BPR5EIX	6597	
80DS	80			B7HS	5110	0,6	B7HVX	7836	204	BR7HIX	7067	
X 90	90			BP5ES	6511	0,6	BP5EVX	5470		BPR5EIX	6597	
XZ 90	90			BP5ES	6511	0,6	BP5EVX	5470		BPR5EIX	6597	
Baja MSR	100			B8ES	2411	0,5	B8EVX	7051	201	BR8EIX	5044	
SR 100	100			B8ES	2411	0,5	B8EVX	7051	201	BR8EIX	5044	
M 125	125			BP5ES	6511	0,6	BP5EVX	5470		BPR5EIX	6597	
ML 125	125			BP5ES	6511	0,6	BP5EVX	5470		BPR5EIX	6597	
MLS 125	125			BP5ES	6511	0,6	BP5EVX	5470		BPR5EIX	6597	
Rapido	125			BP5ES	6511	0,6	BP5EVX	5470		BPR5EIX	6597	
SS 125	125			B9ES	2611	0,5	B9EVX	7254	202	BR9EIX	3981	
SX 125	125			B7ES	1111	0,5	B7EVX	6934				
SXT 125	125			B9ES	2611	0,5	B9EVX	7254	202	BR9EIX	3981	
SS 175	175			B9ES	2611	0,5	B9EVX	7254	202	BR9EIX	3981	
SX 175	175			B9ES	2611	0,5	B9EVX	7254	202	BR9EIX	3981	
MX 250	250					0,6	B10EVX	7335		BR10EIX	6801	
SS 250	250			B9ES	2611	0,5	B9EVX	7254	202	BR9EIX	3981	
SX 250	250			B9ES	2611	0,5	B9EVX	7254	202	BR9EIX	3981	
all models / Alle Modelle	350	73 -	74	B8ES	2411	0,5	B8EVX	7051	201	BR8EIX	5044	
All 883 models	883	85 -		DPR7EA-9	5129	0,9	DPR7EVX-9	7682	220	DPR7EIX-9	7803	
XL 53 C/ Custom 53	883	03.98 -		DPR7EA-9	5129	0,9	DPR7EVX-9	7682	220	DPR7EIX-9	7803	
XL-Modelle	900	-	71	B6L	3212	0,7						
XL	1000	71 -	78	B6L	3212	1,0						
XL	1000	79 -	85	BPR6HS-10	2633	1,0						
XL	1100	86 -	87	DCPR7E	3932	1,0				DCPR7EIX	6046	
XR	1100	83 -	85	BPR6ES-11	7822	1,0				BPR6EIX-11	3903	
VRSC- V-Rod	1130	02 -		DCPR8E	4339	1,0				DCPR8EIX	6546	
FL Shovel Head	1200	75 -	81	BPR5ES-11	4424	1,0				BPR5EIX-11	2115	
FL Shovel Head	1200	66 -	74	XR5	5953	0,7				XR5IX	7355	
FL Panhead	1200	48 -	65	XR5	5953	0,7				XR5IX	7355	
FX Shovel Head	1200	66 -	74	XR5	5953	0,7				XR5IX	7355	
FX Shovel Head	1200	75 -	81	BPR5ES-11	4424	1,0				BPR5EIX-11	2115	
FX Panhead	1200	48 -	65	XR5	5953	0,7				XR5IX	7355	

				Order No.		Gold-Palladium		Order No.	Quick-No.		Order No.
HARLEY-DAVIDSON											
XL V-2 Evolution	1200	86 -	DCPR7E	3932	1,0					DCPR7EIX	6046
XL 1200R Sportster Evolution	1200	04 -	DCPR7E	3932	1,0					DCPR7EIX	6046
FL Shovel Head	1340	82 - 84	BPR5ES-11	4424	1,0					BPR5EIX-11	2115
FL Shovel Head	1340	78 - 81	BPR5ES-11	4424	1,0					BPR5EIX-11	2115
FL V-2 Evolution	1340	84 - 00	BPR5ES-11	4424	1,0					BPR5EIX-11	2115
FX Shovel Head	1340	82 - 84	BPR5ES-11	4424	1,0					BPR5EIX-11	2115
FX Shovel Head	1340	78 - 81	BPR5ES-11	4424	1,0					BPR5EIX-11	2115
FX V-2 Evolution	1340	84 - 00	BPR5ES-11	4424	1,0					BPR5EIX-11	2115
FL TC 88	1450	98 -	DCPR7E	3932	1,0					DCPR7EIX	6046
FX TC 88	1450	98 -	DCPR7E	3932	1,0					DCPR7EIX	6046
HEINKEL											
Perle Moped			B8HS	5510	0,5	B8HVX	2634	205	BR8HIX		7001
HERCULES											
Saxnette	30	01.87 -	BP4	2911	0,5						
City Bike C1	50	10.72-08.78	B6HS	4510	0,7	B6HVX	7435	203	BR6HIX		3419
City Bike C2	50	10.72-08.78	B6HS	4510	0,7	B6HVX	7435	203	BR6HIX		3419
City Bike C3	50	09.74-08.78	B6HS	4510	0,7	B6HVX	7435	203	BR6HIX		3419
Hobby Rider HR 1	50	10.72-12.87	B6HS	4510	0,7	B6HVX	7435	203	BR6HIX		3419
Hobby Rider HR 2	50	10.72-12.87	B6HS	4510	0,7	B6HVX	7435	203	BR6HIX		3419
Jogging	50		B6HS	4510	0,5	B6HVX	7435	203	BR6HIX		3419
K 50	50	-08.78	B8HS	5510	0,7	B8HVX	2634	205	BR8HIX		7001
K 50 Ultra	50	-08.78	B8HS	5510	0,7	B8HVX	2634	205	BR8HIX		7001
K 50 Ultra II	50	-08.78	B8HS	5510	0,5	B8HVX	2634	205	BR8HIX		7001
K 50 Ultra LC	50	-08.78	B9ES	2611	0,5	B9EVX	7254	202	BR9EIX		3981
K 50 Ultra LC II	50	-08.78	B9ES	2611	0,5	B9EVX	7254	202	BR9EIX		3981
K 50 Ultra LC III	50	-08.78	B9ES	2611	0,5	B9EVX	7254	202	BR9EIX		3981
KX 5	50	01.86 -	BP7HS	5111	0,5	BP7HVX	7468		BPR7HIX		5944
Lastboy	50		B7HS	5110	0,5	B7HVX	7836	204	BR7HIX		7067
M1	50	10.72-12.77	B6HS	4510	0,5	B6HVX	7435	203	BR6HIX		3419
M2	50	10.72-12.77	B6HS	4510	0,5	B6HVX	7435	203	BR6HIX		3419
M4	50	09.74-12.78	B6HS	4510	0,5	B6HVX	7435	203	BR6HIX		3419
M5	50	09.74-12.78	B6HS	4510	0,5	B6HVX	7435	203	BR6HIX		3419
MK 1S	50	01.78-08.80	B6HS	4510	0,5	B6HVX	7435	203	BR6HIX		3419
MK 2S	50	01.78-08.80	B6HS	4510	0,5	B6HVX	7435	203	BR6HIX		3419
MP 2	50	10.72-12.77	B6HS	4510	0,5	B6HVX	7435	203	BR6HIX		3419
MP 4	50	10.72-12.77	B6HS	4510	0,5	B6HVX	7435	203	BR6HIX		3419
MX 1	50		B6HS	4510	0,5	B6HVX	7435	203	BR6HIX		3419
MX 1	50	01.89 -	B5HS	4210	0,5						
Optima 3	50	01.78 -	B6HS	4510	0,5	B6HVX	7435	203	BR6HIX		3419
Optima 50	50		BR8HS	4322	0,5	BR8HVX	6265	212	BR8HIX		7001
Prima 2	50		B6HS	4510	0,5	B6HVX	7435	203	BR6HIX		3419
Prima 2S	50	01.89 -	B5HS	4210	0,5						
Prima 3	50		B6HS	4510	0,5	B6HVX	7435	203	BR6HIX		3419
Prima 3S	50	01.89 -	B5HS	4210	0,5						
Prima 4	50		B6HS	4510	0,5	B6HVX	7435	203	BR6HIX		3419
Prima 4LN,5LN	50		B6HS	4510	0,5	B6HVX	7435	203	BR6HIX		3419
Prima 5	50		B6HS	4510	0,5	B6HVX	7435	203	BR6HIX		3419
Prima 5,5S,5SE	50	01.89 -	B5HS	4210	0,5						
Prima 6	50		B6HS	4510	0,5	B6HVX	7435	203	BR6HIX		3419

					Order No.		Gold-Palladium		Order No.	Quick-No.	Iridium		Order No.
HERCULES													
Prima G3	50		B6HS	4510	0,5	B6HVX	7435	203	BR6HIX			3419	
Prima GT	50	01.89 -	B5HS	4210	0,5								
Prima GT,GX	50		B6HS	4510	0,5	B6HVX	7435	203	BR6HIX			3419	
Prima Presto	50		B6HS	4510	0,5	B6HVX	7435	203	BR6HIX			3419	
Prima Pronto	50		B6HS	4510	0,5	B6HVX	7435	203	BR6HIX			3419	
Prima S	50		B6HS	4510	0,5	B6HVX	7435	203	BR6HIX			3419	
Prima SL	50		B6HS	4510	0,5	B6HVX	7435	203	BR6HIX			3419	
Prima SX	50		B6HS	4510	0,5	B6HVX	7435	203	BR6HIX			3419	
Sport Bike SB1	50	10.72 -08.74	B8HS	5510	0,5	B8HVX	2634	205	BR8HIX			7001	
Sport Bike SB2	50	10.72 -08.79	B6HS	4510	0,5	B6HVX	7435	203	BR6HIX			3419	
Sport Bike SB3	50	09.74 -08.79	B6HS	4510	0,5	B6HVX	7435	203	BR6HIX			3419	
Sport Bike SB5	50	09.74 -08.76	B8HS	5510	0,5	B8HVX	2634	205	BR8HIX			7001	
Supra 2D,3D	50	06.80 -	B6HS	4510	0,5	B6HVX	7435	203	BR6HIX			3419	
Supra 4	50	06.78 -	B7HS	5110	0,5	B7HVX	7836	204	BR7HIX			7067	
Supra 4GP	50	01.80 -	B6HS	4510	0,5	B6HVX	7435	203	BR6HIX			3419	
Supra Enduro	50	03.80 -	B6HS	4510	0,5	B6HVX	7435	203	BR6HIX			3419	
Ultra 50	50		B9ES	2611	0,5	B9EVX	7254	202	BR9EIX			3981	
XE 5	50	01.86 -	BP7HS	5111	0,5	BP7HVX	7468		BPR7HIX			5944	
ZX 1	50		B7ES	1111	0,5	B7EVX	6934						
RX 9	80		B8HS	5510	0,5	B8HVX	2634	205	BR8HIX			7001	
Ultra 80 LC	80		B8HS	5510	0,5	B8HVX	2634	205	BR8HIX			7001	
Ultra 80 AC	80	01.82 -	B7HS	5110	0,5	B7HVX	7836	204	BR7HIX			7067	
XE 9	80	01.82 -	B8HS	5510	0,5	B8HVX	2634	205	BR8HIX			7001	
K 100 X	100		B8HS	5510	0,5	B8HVX	2634	205	BR8HIX			7001	
K 125 BW Military	125	09.74 -	B8HS	5510	0,5	B8HVX	2634	205	BR8HIX			7001	
K 125 GS	125		B9ES	2611	0,5	B9EVX	7254	202	BR9EIX			3981	
K 125 MC	125		B9ES	2611	0,5	B9EVX	7254	202	BR9EIX			3981	
K 125 S	125	10.72 -08.79			0,5	B9EVX	7254		BR9EIX			3981	
K 125 T	125	10.72 -08.79			0,5	B9EVX	7254		BR9EIX			3981	
K 125 X	125		B8HS	5510	0,5	B8HVX	2634	205	BR8HIX			7001	
175 GS	175		B9ES	2611	0,5	B9EVX	7254	202	BR9EIX			3981	
250 GS	250		B9ES	2611	0,5	B9EVX	7254	202	BR9EIX			3981	
W 2000 (Wankel)	294		BR8ES	5422	0,5	BR8EVX	1262	207	BR8EIX			5044	
350 GS	350				0,5	B9EVX	7254		BR9EIX			3981	
HESKETH													
V 1000	1000		DR8ES	5423	0,7	DR8EVX	6354	217	DR8EIX			6681	
HIGHLAND													
450MX	450		CR8E	1275	0,6	CR8EVX	6487	226	CR8EIX			4218	
Allroad	450		CR8E	1275	0,6	CR8EVX	6487	226	CR8EIX			4218	
Outback	450		CR8E	1275	0,6	CR8EVX	6487	226	CR8EIX			4218	
Super Motard	450		CR8E	1275	0,6	CR8EVX	6487	226	CR8EIX			4218	
Dirt Trac	750		CR8E	1275	0,6	CR8EVX	6487	226	CR8EIX			4218	
Dessert Strom	950		CR8E	1275	0,6	CR8EVX	6487	226	CR8EIX			4218	
HM RACING													
Baja SX	50	98 -	B8ES	2411	0,5	B8EVX	7051	201	BR8EIX			5044	
CRX Junior & Senior	50	01 -	B8HS	5510	0,5	B8HVX	2634	205	BR8HIX			7001	
CRX Racing Junior & Senior	50	01 -	B8HS	5510	0,5	B8HVX	2634	205	BR8HIX			7001	
Derapage	50	98 -	B8ES	2411	0,5	B8EVX	7051	201	BR8EIX			5044	
MX Junior & Senior	50	01 -	B8HS	5510	0,5	B8HVX	2634	205	BR8HIX			7001	

								
	Order No.	U	Gold-Palladium	Platin	Order No.	Quick-No.	Iridium	Order No.
HM RACING								
Six	50	98 -	B8ES	2411	0,5	B8EVX	7051	201 BR8EIX 5044
HMZ								
Cruise 125	125	96 -	D8EA	2120	0,6	D8EVX	2850	216 DR8EIX 6681
HONDA								
Camino PA 50	50	01.75 -12.87	BPR6HS	7022	0,7	BPR6HVX	2740	214 BPR6HIX 4085
CB 50	50		CR6HS	7023	0,7			223 CR6HIX 7274
CB 50 Y	50	01.73 -01.83	CR6HS	7023	0,7			223 CR6HIX 7274
CY 50	50	01.81 -	CR6HS	7023	0,7			223 CR6HIX 7274
Elite 50/S	50		BPR6HSA	4632	0,7	BPR6HVX	2740	BPR6HIX 4085
MB 50 F (AC01)	50		BR8HS	4322	0,8	BR8HVX	6265	212 BR8HIX 7001
MB 50 S (AC01)	50		BR7HS	4122	0,8			211 BR7HIX 7067
MBX 50 M (AC05)	50		BR9ES	5722	0,8	BR9EVX	1265	208 BR9EIX 3981
MBX 50 S (AC05)	50		BR9ES	5722	0,7	BR9EVX	1265	208 BR9EIX 3981
MBX 50 SD (AC05)	50		BR6ES	4922	0,7			
MR 50	50		BR6HS	3922	0,7			209 BR6HIX 3419
MT 50 F (AD04)	50		BR8HS	4322	0,7	BR8HVX	6265	212 BR8HIX 7001
MT 50 S (AD04)	50		BR6ES	4922	0,7			
MTX 50 R	50		BR8ES	5422	0,7	BR8EVX	1262	207 BR8EIX 5044
MTX 50 S	50	86 -	BR7HS	4122	0,7			211 BR7HIX 7067
NC 50	50		BPR4HS	7823	0,7			
NE 50	50		BPR6HSA	4632	0,7	BPR6HVX	2740	BPR6HIX 4085
NE 50 Vision	50	90 -	BR6HSA	4296	0,7			210 BR6HIX 3419
NSR 50	50	89 -	BR5ES	4722	0,8			
NT 50	50		BPR6HSA	4632	0,7	BPR6HVX	2740	BPR6HIX 4085
NX 50	50		BPR5HS	6222	0,7			
NX 50 M	50		BPR5HS	6222	0,7			
PA 50	50	84 -	BP6HS	4511	0,7	BP6HVX	4635	BPR6HIX 4085
PF 50	50		BR6HS	3922	0,7			209 BR6HIX 3419
PK 50 DX (AB25)	50	95 -	BR6HSA	4296	0,7			210 BR6HIX 3419
PK 50 Wallaroo	50	90 -	BR6HSA	4296	0,7			210 BR6HIX 3419
PM 50	50		BR6HS	3922	0,7			209 BR6HIX 3419
PX 50	50	84 -	BPR5HS	6222	0,7			
PX 50 E	50	80 -	BPR5HS	6222	0,7			
PX 50 R	50	85 -	BPR5HS	6222	0,7			
PZ 50	50		BR6HS	3922	0,7			209 BR6HIX 3419
SA 50 (AF29)	50		BR6HSA	4296	0,7			210 BR6HIX 3419
SE 50	50		BPR6HSA	4632	0,7	BPR6HVX	2740	BPR6HIX 4085
SFX 50	50	96 -	BR6HSA	4296	0,6			210 BR6HIX 3419
SH 50	50	01.84 -	BR8HS	4322	0,7	BR8HVX	6265	212 BR8HIX 7001
SH 50 T (AF40)	50	97 -	BR6HSA	4296	0,7			210 BR6HIX 3419
SJ 50 Bali	50		BR6HSA	4296	0,6			210 BR6HIX 3419
SS 50 (Z)	50		C7HSA	4629	0,6	C7HVX	4533	CR7HIX 7544
ST 50 C (AB23) Dax	50		CR6HSA	2983	0,7			CR6HIX 7274
TLM 50	50		BR8ES	5422	0,8	BR8EVX	1262	207 BR8EIX 5044
XL 50	50	01.80 -	CR6HS	7023	0,7			223 CR6HIX 7274
XR 50	50	93 - 02	CR6HSA	2983	0,7			CR6HIX 7274
XR 50 R	50	03 -	CR6HSA	2983	0,7			CR6HIX 7274
Z 50 GZ (Monkey)	50	01.80 -12.84	CR6HS	7023	0,7			223 CR6HIX 7274
Z 50 J (Monkey)	50		CR6HS	7023	0,7			223 CR6HIX 7274
Z 50 R (Monkey)	50	94 -	CR6HSA	2983	0,7			CR6HIX 7274



Order No.



Gold-Palladium



Platin

Order No.

Quick-No.

Iridium



Order No.

HONDA

ZB 50 P (AB22)(Monkey)	50	88 -	CR6HSA	2983	0,7					CR6HIX	7274
CT 70	70	92 -	CR6HSA	2983	0,7					CR6HIX	7274
ST 70	70	94 -	CR6HSA	2983	0,7					CR6HIX	7274
NS-1	75	96 -	BR8ECS	3972	0,7						
CR 80 R	80	86 -	BR10EG	3830	0,6						
CR 80 R	80	- 85	BR9ES	5722	0,8	BR9EVX	1265	208		BR9EIX	3981
CY 80	80		CR7HS	7223	0,7					CR7HIX	7544
MB 80 (HC01)	80	01.80 -	BR8HS	4427	0,7	BR8HVX	6265	212		BR8HIX	7001
MBX 80 SWD/SW2D (HC04)	80	87 -	BR9ES	5722	0,8	BR9EVX	1265	208		BR9EIX	3981
MCX 80 (HC05)	80	01.80 -	BR9ES	5722	0,8	BR9EVX	1265	208		BR9EIX	3981
MT 80 F	80		BR9HS	4522	0,7						
MT 80 S (HD02)	80		BR8HS	4322	0,7	BR8HVX	6265	212		BR8HIX	7001
MTX 80 C	80	82 -	BR9HS	4522	0,7						
MTX 80 R (D) (HD08)	80		BR9ES	5722	0,7	BR9EVX	1265	208		BR9EIX	3981
MTX 80 R (F) (HD08)	80		BR8ES	5422	0,7	BR8EVX	1262	207		BR8EIX	5044
MTX 80 R II (HD09)	80	87 -	BR9ES	5722	0,8	BR9EVX	1265	208		BR9EIX	3981
MTX 80 RS (HD08)	80	83 - 85	BR9ES	5722	0,8	BR9EVX	1265	208		BR9EIX	3981
NSR 80	80		BR8ES	5422	0,8	BR8EVX	1262	207		BR8EIX	5044
SH 80 E Scoopy	80	84 -	BPR6HS	7022	0,7	BPR6HVX	2740	214		BPR6HIX	4085
XR 80R	80	92 -	CR7HSA	4549	0,7					CR7HIX	7544
CR 85 R	85	03 -	BR10EG	3830	0,6						
CR 85 R 2	85	03 -	BR10EG	3830	0,6						
EZ 90	90	93 -	BR7HS	4122	0,7			211		BR7HIX	7067
NH 90 M	90	93 -	BPR6HSA	4632	0,7	BPR6HVX	2740			BPR6HIX	4085
NH 90 Yuppy	90	90 -	BPR6HSA	4632	0,7	BPR6HVX	2740			BPR6HIX	4085
XR 100R	100	92 -	CR7HSA	4549	0,7					CR7HIX	7544
CG 110	110		DR8ESL	2923	0,7	DR8EVX	6354	218		DR8EIX	6681
CA 125 Rebel (JC24)	125	95 -	CR6HSA	2983	0,7					CR6HIX	7274
CA 125 C Rebel (JC26)	125	97 -	CR6HSA	2983	0,7					CR6HIX	7274
CB 125	125		DR8ES	5423	0,7	DR8EVX	6354	217		DR8EIX	6681
CB 125 K	125		D8HA	7012	0,7						
CB 125 T	125		CR8HS	7423	0,7	CR8HVX	7236			CR8HIX	7669
CB 125 Y	125		CR8HS	7423	0,7	CR8HVX	7236			CR8HIX	7669
CBR 125 R	125	04 -	CR9E	6263	0,7	CR9EVX	5943	227		CR9EIX	3521
CG 125 (JC27)	125	98 -	DPR8EA-9	4929	0,9	DPR8EVX-9	2872	221		DPR8EIX-9	2202
CG 125	125		DR8ESL	2923	0,6	DR8EVX	6354	218		DR8EIX	6681
CH 125	125		DPR7EA-9	5129	0,9	DPR7EVX-9	7682	220		DPR7EIX-9	7803
CLR 125 Cityfly (JD18A/B)	125	98 -	DPR8EA-9	4929	0,9	DPR8EVX-9	2872	221		DPR8EIX-9	2202
CM 125 (JC05)	125		CR7HS	7223	0,7					CR7HIX	7544
CM 125 C Custum	125	94 -	CR7HSA	4549	0,7					CR7HIX	7544
CR 125 R	125		BR9EG	3230	0,6	BR9EVX	1265			BR9EIX	3981
CR 125 R	125	03 -	BR9EG	3230	0,6	BR9EVX	1265			BR9EIX	3981
Italia 125 (I)	125		DR8ESL	2923	0,6	DR8EVX	6354	218		DR8EIX	6681
Lead 125 (JF01)	125		BPR6HS	7022	0,7	BPR6HVX	2740	214		BPR6HIX	4085
MBX 125 F	125		BR9ES	5722	0,7	BR9EVX	1265	208		BR9EIX	3981
MTX 125	125		BR9ES	5722	0,7	BR9EVX	1265	208		BR9EIX	3981
MTX 125 R (I)	125		BR8ES	5422	0,7	BR8EVX	1262	207		BR8EIX	5044
MTX 125 R2 (I)	125		BR9ES	5722	0,7	BR9EVX	1265	208		BR9EIX	3981
NS 125 F (I)	125		BR9ES	5722	0,6	BR9EVX	1265	208		BR9EIX	3981
NS 125 R (I)	125		BR9ES	5722	0,6	BR9EVX	1265	208		BR9EIX	3981
NSR 125 F	125		BR9ECS	3570	0,8						
NSR 125 R (JC22)	125		BR9ECS	3570	0,8						



Order No.



Gold-Palladium



Order No.

Quick-No.







Iridium



Order No.

HONDA

VT 250 F2	250		DPR8EA-9	4929	0,9	DPR8EVX-9	2872	221	DPR8EIX-9	2202
XL 250 R (MD11)	250	- 83	DR8ESL	2923	0,7	DR8EVX	6354	218	DR8EIX	6681
XL 250 R (MD11)	250	86 -	DPR9Z	4830	0,7					
XL 250 R (MD11)	250	84 - 85	DPR9Z	4830	0,8					
XL 250 S (MD11)	250	01.73-12.83	DR8ESL	2923	0,6	DR8EVX	6354	218	DR8EIX	6681
XR 250 L	250	92 -	DPR8Z	4730	0,7					
XR 250 R	250	- 83	DR8ESL	2923	0,6	DR8EVX	6354	218	DR8EIX	6681
XR 250 R / RN	250	84 -	DPR9Z	4830	0,7					
XL 350 R (ND03)	350	85 - 87	DPR8EA-9	4929	0,9	DPR8EVX-9	2872	221	DPR8EIX-9	2202
XR 350 R	350		DPR8EA-9	4929	0,9	DPR8EVX-9	2872	221	DPR8EIX-9	2202
400 Hawk (I)	400		DR8ES	5423	0,7	DR8EVX	6354	217	DR8EIX	6681
CB 400 A	400	01.79 -	DR8ES	5423	0,7	DR8EVX	6354	217	DR8EIX	6681
CB 400 N	400	01.78-12.84	DR8ES	5423	0,7	DR8EVX	6354	217	DR8EIX	6681
CB 400 T	400		DR8ES	5423	0,7	DR8EVX	6354	217	DR8EIX	6681
CB-1 (NC27)	400	91 -	CR8EH-9	5666	0,9	CR8EHVX-9	4546	228	CR8EHIX-9	3797
CBX 400 F	400		DPR9Z	4830	0,7					
CBX 400 F2	400		DPR9Z	4830	0,7					
CBX 400 SS (I)	400		DPR9Z	4830	0,7					
CM 400 T	400	01.80-12.84	DR8ES	5423	0,7	DR8EVX	6354	217	DR8EIX	6681
CX 400 C	400		DR8ESL	2923	0,7	DR8EVX	6354	218	DR8EIX	6681
CX 400 F2	400		DR8ESL	2923	0,7	DR8EVX	6354	218	DR8EIX	6681
NS 400	400		BR9ES	5722	0,8	BR9EVX	1265	208	BR9EIX	3981
NS 400 R (NC19)	400	85 -	BR9ES	5722	0,8	BR9EVX	1265	208	BR9EIX	3981
RVF 400 (NC35)	400		ER9EH	5869	0,6					
VF 400 F	400	01.85 -	DPR8EA-9	4929	0,9	DPR8EVX-9	2872	221	DPR8EIX-9	2202
VFR 400 R (NC24)	400	87 -	C8EH-9	7473	0,7	C8EHVX-9	4450		CR8EHIX-9	3797
VFR 400 R (NC30)	400	91 -	ER9EH	5869	0,7					
XL 400	400	01.84 -	DR8EA	7162	0,7	DR8EVX	6354		DR8EIX	6681
XR 400 R	400	96 -	DPR8Z	4730	0,7					
CB 450 N (PC14)	450	85 -	DR8ES	5423	0,7	DR8EVX	6354	217	DR8EIX	6681
CB 450 S (PC17)(D)	450	86 - 88	DR8ESL	2923	0,7	DR8EVX	6354	218	DR8EIX	6681
CB 450 S (PC17)(I)	450		DR8ES	5423	0,7	DR8EVX	6354	217	DR8EIX	6681
CMX 450 C	450		DPR8EA-9	4929	0,9	DPR8EVX-9	2872	221	DPR8EIX-9	2202
CRF 450 R 4T	450	02 -			1,1				IFR8H-11	5068
CRS R2 / R3	450	02 -			1,1				IFR9H-11	6588
CR 480 R	480		BR8EG	3130	0,5					
CB 500 (PC26)	500	94 -	CR9EH-9	7502	0,9	CR9EHVX-9	3872	229	CR9EHIX-9	6216
CB 500 (K1)	500	- 75			0,6	D7EVX	2734			
CB 500 (K3)	500	- 75	DR7ES	3123	0,6					
CB 500 (PC32)	500	96 -	CR8EH-9	5666	0,9	CR8EHVX-9	4546	228	CR8EHIX-9	3797
CB 500 R	500		BR8EG	3130	0,5					
CB 500 / S (PC32)	500	98 -	CR8EH-9	5666	0,9	CR8EHVX-9	4546	228	CR8EHIX-9	3797
CBF 500	500	04 -	CR8EH-9S		0,9					
CBR 500 F	500		DPR8EA-9	4929	0,9	DPR8EVX-9	2872	221	DPR8EIX-9	2202
CR 500	500		BR8EG	3130	0,5					
CX 500	500		DR8ESL	2923	0,7	DR8EVX	6354	218	DR8EIX	6681
CX 500 C (PC01)	500	01.79-12.84	DR8ESL	2923	0,7	DR8EVX	6354	218	DR8EIX	6681
CX 500 E (PC06)	500	01.79-12.84	DR8ESL	2923	0,6	DR8EVX	6354	218	DR8EIX	6681
CX 500 Turbo (PC03)	500	01.83 -			0,9	DPR8EVX-9	2872		DPR8EIX-9	2202
FT 500 (PC07)	500	01.82-12.85	DR8EA	7162	0,7	DR8EVX	6354		DR8EIX	6681
GB 500 (PC16)	500	92 -	DPR8EA-9	4929	0,9	DPR8EVX-9	2872	221	DPR8EIX-9	2202
GL 500 (PC02)	500	01.79-12.84	DR8ESL	2923	0,6	DR8EVX	6354	218	DR8EIX	6681

					Order No.		Platin 	Order No.	Quick-No.	Iridium 	Order No.
HONDA											
CB 650 SC (RC08)	650	01.80 -	DPR8EA-9	4929	0,9	DPR8EVX-9	2872	221	DPR8EIX-9	2202	
CB 650 Z	650		DR8ESL	2923	0,7	DR8EVX	6354	218	DR8EIX	6681	
CBX 650 E (RC13)	650	83 -	DPR9EA-9	5329	0,9	DPR9EVX-9	3854	222	DPR9EIX-9	5545	
CBX 650 Night Hawk(I)	650		DPR9EA-9	5329	0,9	DPR9EVX-9	3854	222	DPR9EIX-9	5545	
CX 650 C (RC11)	650	01.83 -	DPR8EA-9	4929	0,9	DPR8EVX-9	2872	221	DPR8EIX-9	2202	
CX 650 E (RC13)	650	01.83 -	DPR8EA-9	4929	0,9	DPR8EVX-9	2872	221	DPR8EIX-9	2202	
CX 650 Turbo (RC16)	650	01.82 -			0,9	DPR8EVX-9	2872		DPR8EIX-9	2202	
Deauville NT 650 V (RC47) (647cc)	650	98 -	DPR8EA-9	4929	0,9	DPR8EVX-9	2872	221	DPR8EIX-9	2202	
FMX 650	650	05 -	DPR8EA-9	4929	0,9	DPR8EVX-9	2872	221	DPR8EIX-9	2202	
GL 650 (RC10)	650	01.83 -	DPR8EA-9	4929	0,9	DPR8EVX-9	2872	221	DPR8EIX-9	2202	
NTV 650 (RC33)	650	88 -	DPR8EA-9	4929	0,9	DPR8EVX-9	2872	221	DPR8EIX-9	2202	
NTV 650 Revere (I)	650	01.88 -	DPR8EA-9	4929	0,9	DPR8EVX-9	2872	221	DPR8EIX-9	2202	
NX 650 (RD02)/Dominator	650	88 -	DPR8EA-9	4929	0,9	DPR8EVX-9	2872	221	DPR8EIX-9	2202	
NX 650 Dominator (RD08)(I)	650	01.88 -	DPR8EA-9	4929	0,9	DPR8EVX-9	2872	221	DPR8EIX-9	2202	
SLR 650 (RD09)	650	97 -	DPR8EA-9	4929	0,9	DPR8EVX-9	2872	221	DPR8EIX-9	2202	
XL 650L	650	94 -	DPR8EA-9	4929	0,9	DPR8EVX-9	2872	221	DPR8EIX-9	2202	
Transalp XL 650	650	94 -	DPR8EA-9	4929	0,9	DPR8EVX-9	2872	221	DPR8EIX-9	2202	
XR 650 R (R1)	650	00 -	BKR8E-11	6587	1,1						
XRV 650 (RD03)	650	88 -	DPR8EA-9	4929	0,9	DPR8EVX-9	2872	221	DPR8EIX-9	2202	
Deauville (680cc) 4Ventil	700	06 -	DPR8EA-9	4929	0,9	DPR8EVX-9	2872	221	DPR8EIX-9	2202	
Deauville (680cc) 3Ventil	700	05 -	DPR8EA-9	4929	0,9	DPR8EVX-9	2872	221	DPR8EIX-9	2202	
VT 700 C	700		DPR7EA-9	5129	0,9	DPR7EVX-9	7682	220	DPR7EIX-9	7803	
CB 750 (RC42)	750	92 -	DPR8EA-9	4929	0,9	DPR8EVX-9	2872	221	DPR8EIX-9	2202	
CB 750 (RC04)	750	01.82 -12.83	DR8EA	7162	0,7	DR8EVX	6354		DR8EIX	6681	
CB 750 C (RC06)	750	01.80 -	DR8ES	5423	0,7	DR8EVX	6354	217	DR8EIX	6681	
CB 750 F	750		DR8ES	5423	0,7	DR8EVX	6354	217	DR8EIX	6681	
CB 750 F2	750		DR8ES	5423	0,7	DR8EVX	6354	217	DR8EIX	6681	
CB 750 F2N / FI	750	91 -	DPR8EA-9	4929	0,9	DPR8EVX-9	2872	221	DPR8EIX-9	2202	
CB 750 FA (I)	750		DR8ES	5423	0,7	DR8EVX	6354	217	DR8EIX	6681	
CB 750 Four (I)	750		DR8ESL	2923	0,7	DR8EVX	6354	218	DR8EIX	6681	
CB 750 FZ	750		DR8ESL	2923	0,7	DR8EVX	6354	218	DR8EIX	6681	
CB 750 K	750	01.82 -12.83	DR8ES	5423	0,7	DR8EVX	6354	217	DR8EIX	6681	
CB 750 KZ	750		DR8ESL	2923	0,9	DR8EVX	6354	218	DR8EIX	6681	
CB Seven Fifty	750		DPR8EA-9	4929	0,9	DPR8EVX-9	2872	221	DPR8EIX-9	2202	
CBX 750 F (RC17)	750	84 - 86	DPR8EA-9	4929	0,9	DPR8EVX-9	2872	221	DPR8EIX-9	2202	
CBX 750 F2	750		DPR9EA-9	5329	0,9	DPR9EVX-9	3854	222	DPR9EIX-9	5545	
NR 750 (RC40)	750	93 -	CR9EH-9	7502	0,9	CR9EHVX-9	3872	229	CR9EHIX-9	6216	
RVF (RC45)	750	94 -			0,9	CR9EHVX-9	3872		CR9EHIX-9	6216	
Shadow 750	750	04 -	DPR8EA-9	4929	0,9	DPR8EVX-9	2872	221	DPR8EIX-9	2202	
VF 750 C	750	95 - 00	CR8EH-9	5666	0,9	CR8EHVX-9	4546	228	CR8EHIX-9	3797	
VF 750 C Magna	750	94 - 95	CR8EH-9	5666	0,9	CR8EHVX-9	4546	228	CR8EHIX-9	3797	
VF 750 C (RC09)	750	82 - 84	DPR8EA-9	4929	0,9	DPR8EVX-9	2872	221	DPR8EIX-9	2202	
VF 750 C (RC09)	750	86 - 94	DPR9EA-9	5329	0,9	DPR9EVX-9	3854	222	DPR9EIX-9	5545	
VF 750 C (RC44)	750	97 - 00	DPR9EA-9	5329	0,9	DPR9EVX-9	3854	222	DPR9EIX-9	5545	
VF 750 F (RC15)	750	83 - 84	DPR8EA-9	4929	0,9	DPR8EVX-9	2872	221	DPR8EIX-9	2202	
VF 750 S (RC07)	750	82 - 83	DPR8EA-9	4929	0,9	DPR8EVX-9	2872	221	DPR8EIX-9	2202	
VFR 750 F	750	94 -	CR8EH-9	5666	0,9	CR8EHVX-9	4546	228	CR8EHIX-9	3797	
VFR 750 F (I)	750		DPR9EA-9	5329	0,9	DPR9EVX-9	3854	222	DPR9EIX-9	5545	
VFR 750 F (RC24)	750	86 - 87	DPR8EA-9	4929	0,9	DPR8EVX-9	2872	221	DPR8EIX-9	2202	
VFR 750 F (RC24)	750	88 - 89	DPR9EA-9	5329	0,9	DPR9EVX-9	3854	222	DPR9EIX-9	5545	
VFR 750 F (RC36)	750	90 - 94	CR8EH-9	5666	0,9	CR8EHVX-9	4546	228	CR8EHIX-9	3797	
VFR 750 FJ (I)	750		DPR9EA-9	5329	0,9	DPR9EVX-9	3854	222	DPR9EIX-9	5545	



Order No.



Gold-Palladium



Platin

Order No.

Quick-No.







Iridium









Order No.

HONDA

VFR 750 R (RC30)	750	88 -	CR9EH-9	7502	0,9	CR9EHVX-9	3872	229	CR9EHIX-9	6216
VT 750 Black Widow (RC48)	750	00 -	DPR8EA-9	4929	0,9	DPR8EVX-9	2872	221	DPR8EIX-9	2202
VT 750 C (RC29)	750	87 -	DPR8EA-9	4929	0,9	DPR8EVX-9	2872	221	DPR8EIX-9	2202
VT 750 C/C2V (RC44)	750	97 -	DPR8EA-9	4929	0,9	DPR8EVX-9	2872	221	DPR8EIX-9	2202
XLV 750 R (RD01)	750	83 -	DPR8EA-9	4929	0,9	DPR8EVX-9	2872	221	DPR8EIX-9	2202
XRV 750 (RD04)	750	90 - 92	DPR8EA-9	4929	0,9	DPR8EVX-9	2872	221	DPR8EIX-9	2202
XRV 750 (RD07)	750	93 -	DPR8EA-9	4929	0,9	DPR8EVX-9	2872	221	DPR8EIX-9	2202
PC 800 Pacific Coast	800	98 -	DPR7EA-9	5129	0,9	DPR7EVX-9	7682	220	DPR7EIX-9	7803
VFR / VFR ABS	800	02 -			0,9				IMR9B-9H	4888
VFR 800 FI W (RC46)	800	98 -	CR9EH-9	7502	0,9	CR9EHVX-9	3872	229	CR9EHIX-9	6216
CB 900 F	900	01.79 -	DR8ES	5423	0,7	DR8EVX	6354	217	DR8EIX	6681
CB 900 F2	900	01.79 - 12.83	DR8ES	5423	0,7	DR8EVX	6354	217	DR8EIX	6681
CBR 900 RR (SC33)	900	96 -	CR9EH-9	7502	0,9	CR9EHVX-9	3872	229	CR9EHIX-9	6216
CBR 900 RR (SC28)	900	91 -	CR9EH-9	7502	0,9	CR9EHVX-9	3872	229	CR9EHIX-9	6216
CBR 900 RRY (Fireblade)(SC44)	900	00 -			0,9				CR9EH-9	6419
Hornet 900	900	02 -	CR8EH-9	5666	0,9	CR8EHVX-9	4546	228	CR8EHIX-9	3797
CBR 900 RR Fireblade 2002 (SC50)	950	02 -			0,9				IMR9C-9H	6777
CB 1000 F (SC30)	1000	93 - 00	DPR9EA-9	5329	0,9	DPR9EVX-9	3854	222	DPR9EIX-9	5545
CBF 1000	1000	06 -	CR8EH-9	5666	0,9	CR8EHVX-9	4546	228	CR8EHIX-9	3797
CBR 1000 RR Fireblade	1000	04 -			0,9				IMR9C-9HES	5766
CBR 1000 F (SC24)	1000	95 - 00	DPR9EA-9	5329	0,9	DPR9EVX-9	3854	222	DPR9EIX-9	5545
CBR 1000 F (SC21)	1000	87 - 88	DPR9EA-9	5329	0,9	DPR9EVX-9	3854	222	DPR9EIX-9	5545
CBR 1000 F (SC24)	1000	89 - 92	DPR9EA-9	5329	0,9	DPR9EVX-9	3854	222	DPR9EIX-9	5545
CBR 1000 Fireblade (G)	1000	04 -			0,9				IMR9C-9HES	5766
CBR 1000 K (I)	1000		DPR9EA-9	5329	0,9	DPR9EVX-9	3854	222	DPR9EIX-9	5545
GL 1000 (GL1)	1000		DR8ESL	2923	0,7	DR8EVX	6354	218	DR8EIX	6681
Varadero 1000 (SD02)	1000	03 -			0,9				IJR8B-9	4873
Varadero XL 1000 V X (SD01)	1000	99 -			0,9	DPR8EVX-9	2872		DPR8EIX-9	2202
Varadero XL 1000 V (G)(SD02) 69kW	1000	03 -			0,9				IJR8B-9	4873
VF 1000 Bol D'Dor(I)	1000		DPR9EA-9	5329	0,9	DPR9EVX-9	3854	222	DPR9EIX-9	5545
VF 1000 F	1000	- 86	DPR9EA-9	5329	0,9	DPR9EVX-9	3854	222	DPR9EIX-9	5545
VF 1000 F (SC15)	1000	87 -	DPR8EA-9	4929	0,9	DPR8EVX-9	2872	221	DPR8EIX-9	2202
VF 1000 F2 (SC15)	1000	85 -	DPR9EA-9	5329	0,9	DPR9EVX-9	3854	222	DPR9EIX-9	5545
VF 1000 R (SC16)	1000	84 - 86	DPR8EA-9	4929	0,9	DPR8EVX-9	2872	221	DPR8EIX-9	2202
VTR 1000 F (SC36)	1000	97 -			0,9	DPR9EVX-9	3854		DPR9EIX-9	5545
VTR1000 SP-1	1000	00 - 01			1,1				FR9BI-11	4709
VTR1000 SP-2	1000	02 -			1,1				IFR9H-11	6588
CBX 1000 (CB1)	1050		DR8ESL	2923	0,7	DR8EVX	6354	218	DR8EIX	6681
CB 1100 F (SC11)	1100		DR8ES	5423	0,7	DR8EVX	6354	217	DR8EIX	6681
CB 1100 R (SC08)	1100		DR8ES	5423	0,7	DR8EVX	6354	217	DR8EIX	6681
CBR 1100 XX Super Blackbird	1100	01 -			0,9				IMR9C-9H	6777
CBR 1100 XX (SC35)	1100	97 - 00			0,9	CR9EHVX-9	3872		CR9EHIX-9	6216
GL 1100 (SC02)	1100	82 -	DPR8EA-9	4929	0,9	DPR8EVX-9	2872	221	DPR8EIX-9	2202
GL 1100 (SC02)	1100	- 81	DR8ESL	2923	0,7	DR8EVX	6354	218	DR8EIX	6681
GL 1100 DX (SC02)	1100	82 -	DPR8EA-9	4929	0,9	DPR8EVX-9	2872	221	DPR8EIX-9	2202
GL 1100 DX (SC02)	1100	- 81	DR8ESL	2923	0,7	DR8EVX	6354	218	DR8EIX	6681
GL 1100 R	1100		DR8ES	5423	0,7	DR8EVX	6354	217	DR8EIX	6681
ST 1100 CBS	1100	96 -	CR8EH-9	5666	0,8	CR8EHVX-9	4546	228	CR8EHIX-9	3797
ST 1100 (SC26)	1100	90 -	CR8EH-9	5666	0,9	CR8EHVX-9	4546	228	CR8EHIX-9	3797
ST 1100 AN (SC26)	1100	92 -	CR8EH-9	5666	0,9	CR8EHVX-9	4546	228	CR8EHIX-9	3797
VF 1100 C (SC12)	1100	83 -	DPR8EA-9	4929	0,9	DPR8EVX-9	2872	221	DPR8EIX-9	2202
VT 1100 C3 W Shadow Aero(SC39A/E/C)	1100	98 - 00	DPR7EA-9	5129	0,9	DPR7EVX-9	7682	220	DPR7EIX-9	7803

					Order No.		Gold-Palladium	Platin 	Order No.	Quick-No.	Iridium 	Order No.
HONDA												
VT 1100 C	1100	95 - 00	DPR7EA-9	5129	0,9	DPR7EVX-9	7682	220	DPR7EIX-9	7803		
VT 1100 C (SC23)	1100	88 - 95	DPR7EA-9	5129	0,9	DPR7EVX-9	7682	220	DPR7EIX-9	7803		
VT 1100 C (SC23)	1100	94 - 95	DPR8EA-9	4929	0,9	DPR8EVX-9	2872	221	DPR8EIX-9	2202		
VT 1100 C2 (SC32)	1100	95 -	DPR7EA-9	5129	0,9	DPR7EVX-9	7682	220	DPR7EIX-9	7803		
X-Eleven	1100	00 -			0,9	CR8EHVX-9	4546		CR8EHIH-9	3797		
GL 1200 (SC14)	1200	84 - 87	DPR8EA-9	4929	0,9	DPR8EVX-9	2872	221	DPR8EIX-9	2202		
CB 1300	1300	03 -	DPR9EA-9	5329	0,9	DPR9EVX-9	3854	222	DPR9EIX-9	5545		
CB 1300 S	1300	05 -	DPR8EA-9	4929	0,9	DPR8EVX-9	2872	221	DPR8EIX-9	2202		
Pan European (SC51)	1300	02 -	CR8EH-9	5666	0,9	CR8EHVX-9	4546	228	CR8EHIH-9	3797		
VTX 1300	1300	03 -	DCPR6E	3481	0,8							
VTX 1300S	1300	03 -	DCPR6E	3481	0,8							
X 4	1300	97 -	DPR9EA-9	5329	0,9	DPR9EVX-9	3854	222	DPR9EIX-9	5545		
F 6 C	1500	11.96 -	DPR7EA-9	5129	0,9	DPR7EVX-9	7682	220	DPR7EIX-9	7803		
GL 1500 (SC22)	1500	89 - 93	DPR7EA-9	5129	0,9	DPR7EVX-9	7682	220	DPR7EIX-9	7803		
GL 1500 C F6C (SC34)	1500	97 -	DPR7EA-9	5129	0,9	DPR7EVX-9	7682	220	DPR7EIX-9	7803		
GL 1500 C (SC34)	1500	97 -	DPR7EA-9	5129	0,9	DPR7EVX-9	7682	220	DPR7EIX-9	7803		
GL 1500 SE.A	1500	95 -	DPR7EA-9	5129	0,9	DPR7EVX-9	7682	220	DPR7EIX-9	7803		
GL 1500A/SE	1500	94 - 94	DPR6EA-9	5531	0,9							
VTX 1500 (Twinspark)	1500	03 -			1,1				IFR6L11	3687		
Gold Wing (GL1800)	1800	01 -	BKR6E-11	2756	1,1	BKR6EVX-11	3540		BKR6EIX-11	3764		
VTX 1800	1800	01 -			1,1				IFR6L-11	3678		
HOREX												
Regina 400	400	53 - 56	B8HS	5510	0,6	B8HVX	2634	205	BR8HIX	7001		
HRD												
Slide Sonic Supermotorrad	50	98 -	BR8ES	5422	0,6	BR8EVX	1262	207	BR8EIX	5044		
GS Enduro	50	98 - 99	BR8ES	5422	0,6	BR8EVX	1262	207	BR8EIX	5044		
Sonic 2 SM	50	99 -	BR8ES	5422	0,6	BR8EVX	1262	207	BR8EIX	5044		
Sonic 2 Trail	50	99 -	BR8ES	5422	0,6	BR8EVX	1262	207	BR8EIX	5044		
Super Mot. Cabr.	125	99 -	CR9EB	6955	0,7				CR9EIX	3521		
Trail Cabr.	125	99 -	CR9EB	6955	0,7				CR9EIX	3521		
HUSABERG												
FE 350	350	91 - 99	C8E	7471	0,7	CR8EVX	6487		CR8EIX	4218		
MC 350	350	- 99	C8E	7471	0,7	CR8EVX	6487		CR8EIX	4218		
400	400	03 -			0,6	DCPR8EVX	2265					
FC 400	400	97 - 99	C8E	7471	0,7	CR8EVX	6487		CR8EIX	4218		
FE 400	400	97 - 99	C8E	7471	0,7	CR8EVX	6487		CR8EIX	4218		
FE 400 e	400	00 - 02	DCPR8E	4179	0,6	DCPR8EVX	2265		DCPR8EIX	6546		
FS 400 c	400	00 - 02	DCPR8E	4179	0,6	DCPR8EVX	2265		DCPR8EIX	6546		
FS 400 e	400	00 - 02	DCPR8E	4179	0,6	DCPR8EVX	2265		DCPR8EIX	6546		
450	450	03 -			0,6	DCPR8EVX	2265					
FC 470/6	470	00 - 02	DCPR8E	4179	0,6	DCPR8EVX	2265		DCPR8EIX	6546		
FX 470 e	470	00 - 02	DCPR8E	4179	0,6	DCPR8EVX	2265		DCPR8EIX	6546		
FC 499MX	499	95 - 99	C8E	7471	0,7	CR8EVX	6487		CR8EIX	4218		
FE 500	500	91 - 94	C8E	7471	0,7	CR8EVX	6487		CR8EIX	4218		
FE 500	500	91 - 99	C8E	7471	0,7	CR8EVX	6487		CR8EIX	4218		
FE 501 e	500	00 -	DCPR8E	4179	0,6	DCPR8EVX	2265		DCPR8EIX	6546		
MC 501	500	- 99	C8E	7471	0,7	CR8EVX	6487		CR8EIX	4218		
501	501	03 -			0,6	DCPR8EVX	2265					
FC 501	501	95 - 99	C8E	7471	0,7	CR8EVX	6487		CR8EIX	4218		

					Order No.		Platin 	Order No.	Quick-No. 	Iridium	Order No.
HUSABERG											
FE 501 E	501	93 - 99	C8E	7471	0,7	CR8EVX	6487		CR8EIX		4218
FE 501	501	93 - 99	C8E	7471	0,7	CR8EVX	6487		CR8EIX		4218
FX 501	501	97 - 99	C8E	7471	0,7	CR8EVX	6487		CR8EIX		4218
FX 501	501	97 - 99	C8E	7471	0,7	CR8EVX	6487		CR8EIX		4218
550	550	03 -			0,6	DCPR8EVX	2265				
FC 550/4	550	00 -	DCPR8E	4179	0,6	DCPR8EVX	2265		DCPR8EIX		6546
FC 550/6	550	00 -	DCPR8E	4179	0,6	DCPR8EVX	2265		DCPR8EIX		6546
FC 600	600	92 - 99	C8E	7471	0,7	CR8EVX	6487		CR8EIX		4218
FE 600	600	92 - 99	C8E	7471	0,7	CR8EVX	6487		CR8EIX		4218
FES 600 E	600	98 - 99	C8E	7471	0,7	CR8EVX	6487		CR8EIX		4218
FX 600	600	97 - 99	C8E	7471	0,7	CR8EVX	6487		CR8EIX		4218
FX 600	600	97 - 99	C8E	7471	0,7	CR8EVX	6487		CR8EIX		4218
FX 600 E	600	97 - 99	C8E	7471	0,7	CR8EVX	6487		CR8EIX		4218
MC 600	600	- 99	C8E	7471	0,7	CR8EVX	6487		CR8EIX		4218
650	650	03 -			0,6	DCPR8EVX	2265				
FE 650 e	650	00 -	DCPR8E	4179	0,6	DCPR8EVX	2265		DCPR8EIX		6546
FS 650 c	650	00 -	DCPR8E	4179	0,6	DCPR8EVX	2265		DCPR8EIX		6546
FS 650 e	650	00 -	DCPR8E	4179	0,6	DCPR8EVX	2265		DCPR8EIX		6546
FX 650 e	650	00 -	DCPR8E	4179	0,6	DCPR8EVX	2265		DCPR8EIX		6546
HUSQVARNA											
Husky boy junior	50	01 -	B6HS	4510	0,5	B6HVX	7435	203	BR6HIX		3419
Husky boy senior	50	01 -	B6HS	4510	0,5	B6HVX	7435	203	BR6HIX		3419
Husky boy racing	50	01 -	B6HS	4510	0,5	B6HVX	7435	203	BR6HIX		3419
Husky boy basic	50	01 -	B8HS	5510	0,5	B8HVX	2634	205	BR8HIX		7001
SM 50	50	02 -	BR9ES	5722	0,6	BR9EVX	1265	208	BR9EIX		3981
WRE 50	50	02 -	BR9ES	5722	0,6	BR9EVX	1265	208	BR9EIX		3981
125 CR	125	92 - 94			0,5	B10EGV	5927				
125 CR	125	90 - 91			0,6	B10EGV	5927				
125 CR	125	97 -			0,5	B10EGV	5927				
CR 125	125	01 -			0,5	BR9EG	3230				
125 CR	125	99 - 00			0,5	BR9EG	3230				
125 NWR	125	99 -			0,5	B95EGV	2145				
125 SM	125	99 -	BR9EG	3230	0,5	BR9EVX	1265		BR9EIX		3981
125 WER	125	99 -	BR9EG	3230	0,5	BR9EVX	1265		BR9EIX		3981
125 WR	125	93 - 94			0,5	B9EGV	5827				
125 WR	125	95 - 00			0,5	B10EGV	5927				
125 WR	125	90 - 92			0,5	B95EGV	2145				
125 WRE	125	98 - 01	B9EG	3530	0,7	B9EGV	5827		BR9EIX		3981
SM 125 / S	125	02 -			0,5	BR9EG	3230				
TC 125	125		BR9EG	3230	0,5	BR9EVX	1265		BR9EIX		3981
WR 125	125	01 -			0,5	BR9EG	3230				
WRE 125	125	02 -	B9EG	3530	0,7	B9EGV	5827		BR9EIX		3981
250 CR	250	90 -			0,5	B9EGV	5827				
250 CR	250	95 - 00			0,5	B9EGV	5827				
250 CR	250	92 - 92			0,5	B9EGV	5827				
250 CR	250	93 - 94			0,6	B10EGV	5927				
250 CR	250	01 -	BR8EG	3130	0,8						
250 WR	250	92 - 95			0,5	B9EGV	5827				
250 WR (5A00)	250	96 - 99			0,6	B9EGV	5827				
250 WR	250	99 -	B8EG	3430	0,5	B8EGV	5627				
260 WR	250	90 -			0,5	B9EGV	5827				



Order No.



Gold-Palladium



Platin

Order No.

Quick-No.

Iridium









Order No.







HUSQVARNA







CR 250	250	01 -	BR8EG	3130	0,6					
TC 250	250	01 -	CR8EB	7784	0,6	CR8EVX	6487		CR8EIX	4218
TE 250 / R	250	01 -	CR8EB	7784	0,6	CR8EVX	6487		CR8EIX	4218
WR 250	250	01 -	B8EG	3430	0,5	B8EGV	5627			
350 TE	350	90 -	C7E	5096	0,7				CR7EIX	7385
350 TE	350	95 -	C7E	5096	0,7				CR7EIX	7385
360 CR	360	91 -			0,5	B8EGV	5627			
360 WR	360	91 - 97			0,5	B8EGV	5627			
360 WR	360	98 - 00	B8EG	3430	0,5	B8EGV	5627			
360 WXC	360	98 -	B8EG	3430	0,5	B8EGV	5627			
WR 360	360	01 -	B8EG	3430	0,5	B8EGV	5627			
390 MX	390		B9ES	2611	0,5	B9EVX	7254	202	BR9EIX	3981
400 MX	400		B9ES	2611	0,5	B9EVX	7254	202	BR9EIX	3981
410 TE (2AA)	400	96 - 00	C7E	5096	0,6				CR7EIX	7385
SM / R 400 R	400	01 -	CR8EB	7784	0,6	CR8EVX	6487		CR8EIX	4218
TE 400 R	400	01 -	CR8EB	7784	0,6	CR8EVX	6487		CR8EIX	4218
TE 410	400	01 -	C7E	5096	0,6				CR7EIX	7385
410 TE	410	95 - 96	C7E	5096	0,7				CR7EIX	7385
430 CR	430		B9ES	2611	0,5	B9EVX	7254	202	BR9EIX	3981
450 SMR	450	04 -	CR8EB	7784	0,6	CR8EVX	6487		CR8EIX	4218
SM 450 R	450	03 -	CR8EB	7784	0,6	CR8EVX	6487		CR8EIX	4218
SMR 450	450	03 -	CR7EB	4663	0,6					
TC 450	450	01 -	CR8EB	7784	0,6	CR8EVX	6487		CR8EIX	4218
TE 450	450	03 -	CR8EB	7784	0,6	CR8EVX	6487		CR8EIX	4218
TE 510	450	03 -	CR8EB	7784	0,6	CR8EVX	6487		CR8EIX	4218
510 TE/AC	510		DP8EA-9	5829	0,9	DPR8EVX-9	2872		DPR8EIX-9	2202
510 TE/TC	510	87 - 90	C7E	5096	0,7				CR7EIX	7385
SM 510 R	510		CR8EB	7784	0,6	CR8EVX	6487		CR8EIX	4218
TC 510	510		CR8EB	7784	0,6	CR8EVX	6487		CR8EIX	4218
TE 510 Centennial	510		CR8EB	7784	0,6	CR8EVX	6487		CR8EIX	4218
SM 570 R	570	01 -	C7E	5096	0,7				CR7EIX	7385
SMR 570	570	03 -	CR7EB	4663	0,6					
SMR 570 NOX	570	02 -	R0045J-10	7400						
SM / R 570	576	07.01 -	CR7EB	4663	0,6					
TC 570	576	07.01 -	CR7EB	4663	0,7					
TE 570	576	07.01 -	CR7EB	4663	0,7					
610 e TE/TC	610	98 -	C7E	5096	0,7				CR7EIX	7385
610 TE/TC	610	91 -	C7E	5096	0,7				CR7EIX	7385
SM 610	610	06 -	CPR8E	7411	0,7					
SM 610 e	610	98 -	C7E	5096	0,7				CR7EIX	7385
SM 610 S	610	03 -	C7E	5096	0,7				CR7EIX	7385
TE 610	610		CPR8E	7411	0,7					
SMR 630	630	04 -	R0045J-10	7400						







HYOSUNG

Aquila (GV125)	125	00 -	CR8E	1275	0,6	CR8EVX	6487	226	CR8EIX	4218
Cruise 125 I (GA125)	125	97 -	DR8EA	7162	0,6	DR8EVX	6354		DR8EIX	6681
Cruise 125 II (GA125F)	125	97 -	CR8EH-9	5666	0,7	CR8EHVX-9	4546	228	CR8EHIX-9	3797
Cruise 125 I (GA125)	125	96 - 96	D8EA	2120	0,6	D8EVX	2850	216	DR8EIX	6681
Cruise 125 II Classic (GA125F-CLS)	125	99 -	CR8EH-9	5666	0,7	CR8EHVX-9	4546	228	CR8EHIX-9	3797
GF 125 (GF125)	125	98 -	CR8EH-9	5666	0,8	CR8EHVX-9	4546	228	CR8EHIX-9	3797
GT 125 (GF125)	125	05 -	CR8EH-9	5666	0,8	CR8EHVX-9	4546	228	CR8EHIX-9	3797

							Order No.		Gold-Palladium	Platin 	Order No.	Quick-No.	Iridium 	Order No.					
HYOSUNG																			
GS 125 (GS125)	125	97 -	DR8EA	7162	0,6	DR8EVX	6354						DR8EIX	6681					
Hyper 125 (GPS125)	125	98 -	DR8EA	7162	0,6	DR8EVX	6354						DR8EIX	6681					
Karion 125	125	02 -	CR8EH-9	5666	0,8	CR8EHVX-9	4546	228					CR8EHIX-9	3797					
Naked 125	125	01 -	CR8E	1275	0,6	CR8EVX	6487	226					CR8EIX	4218					
XRX 125 (RX125)	125	99 -	CR8EH-9	5666	0,8	CR8EHVX-9	4546	228					CR8EHIX-9	3797					
Aquila (GV250) 8V	250	00 -	CR8E	1275	0,6	CR8EVX	6487	226					CR8EIX	4218					
GT 250	250	05 -	CR8E	1275	0,7	CR8EVX	6487	226					CR8EIX	4218					
650 Naked	650	04 -	CR8E	1275	0,6	CR8EVX	6487	226					CR8EIX	4218					
GT 650	650	05 -	CR8E	1275	0,7	CR8EVX	6487	226					CR8EIX	4218					
GT 650 R	650	05 -	CR8E	1275	0,7	CR8EVX	6487	226					CR8EIX	4218					
GT 650 S	650	05 -	CR8E	1275	0,7	CR8EVX	6487	226					CR8EIX	4218					
INDIAN																			
all models / Alle Modelle V-Twin		36 - 53	B7HS	5110	0,6	B7HVX	7836	204					BR7HIX	7067					
Chief	1450	99 - 01	BPR5ES-11	4424	1,1	BPR5EVX-11	2738						BPR5EIX-11	2115					
Scout	1450	01 -	BPR5ES-11	4424	1,1	BPR5EVX-11	2738						BPR5EIX-11	2115					
Spirit	1450	01 -	BPR5ES-11	4424	1,1	BPR5EVX-11	2738						BPR5EIX-11	2115					
Chief	1650	02 -	BPR5ES-11	4424	1,1	BPR5EVX-11	2738						BPR5EIX-11	2115					
ISCH																			
Jupitter 20,6kW	346		BP6HS	4511	0,7	BP6HVX	4635						BPR6HIX	4085					
Jupitter 13,2kW	346		BP6HS	4511	0,7	BP6HVX	4635						BPR6HIX	4085					
6.113.6.114 17,7kW	347		BP6HS	4511	0,7	BP6HVX	4635						BPR6HIX	4085					
6.113-01 17,7kW	347		BP6HS	4511	0,7	BP6HVX	4635						BPR6HIX	4085					
7.107 16,2kW	347		BP7HS	5111	0,7	BP7HVX	7468						BPR7HIX	5944					
Planeta 14,7kW	347		BP7HS	5111	0,7	BP7HVX	7468						BPR7HIX	5944					
Planeta 13,2kW	347		BP7HS	5111	0,7	BP7HVX	7468						BPR7HIX	5944					
ITALJET																			
Pirana, Pulce	50		B6HS	4510	0,5	B6HVX	7435	203					BR6HIX	3419					
Tiffany, Winner	50		B5HS	4210	0,5														
Super Range	125		B7HS	5110	0,5	B7HVX	7836	204					BR7HIX	7067					
JAWA																			
05	50		B6HS	4510	0,6	B6HVX	7435	203					BR6HIX	3419					
20	50		B6HS	4510	0,6	B6HVX	7435	203					BR6HIX	3419					
21 Sport	50		B6HS	4510	0,6	B6HVX	7435	203					BR6HIX	3419					
23 Mustang	50		B6HS	4510	0,6	B6HVX	7435	203					BR6HIX	3419					
207 Babetta	50		B4H	4110	0,6														
210	50	01.85 -	B6HS	4510	0,5	B6HVX	7435	203					BR6HIX	3419					
210 Babetta	50		B5HS	4210	0,6														
215	50	01.86 -	B6HS	4510	0,5	B6HVX	7435	203					BR6HIX	3419					
Moped	50		B8HS	5510	0,5	B8HVX	2634	205					BR8HIX	7001					
Betka 125	125	06 -	C7HSA	4629	0,6	C7HVX	4533	216					CR7HIX	7544					
CZ 125	125	84 -	B8HS	5510	0,5	B8HVX	2634	205					BR8HIX	7001					
CZ 125 De Luxe	125	- 84	B8HS	5510	0,5	B8HVX	2634	205					BR8HIX	7001					
Dakar 125	125	03 -	D8EA	2120	0,7	D8EVX	2850	216					DR8EIX	6681					
Dandy 125	125		DR8ES	5423	0,8	DR8EVX	6354	217					DR8EIX	6681					
Dandy 125	125	99 -	D8EA	2120	0,7	D8EVX	2850	216					DR8EIX	6681					
Sport 125	125	03 -	D8EA	2120	0,7	D8EVX	2850	216					DR8EIX	6681					
CZ 175	175	84 -	B8HS	5510	0,5	B8HVX	2634	205					BR8HIX	7001					
CZ 175 De Luxe	175	- 84	B8HS	5510	0,5	B8HVX	2634	205					BR8HIX	7001					

					Order No.		Gold-Palladium		Order No.	Quick-No.		Order No.
JAWA												
CZ 250	250	84 -	B8HS	5510	0,5	B8HVX	2634	205	BR8HIX			7001
CZ 250 Single/De Luxe	250	- 84	B8HS	5510	0,5	B8HVX	2634	205	BR8HIX			7001
350 Gespann	350	01.87 -	B6HS	4510	0,5	B6HVX	7435	203	BR6HIX			3419
350/640 Black Style	350	93 -	B8HS	5510	0,5	B8HVX	2634	205	BR8HIX			7001
634	350		B6HS	4510	0,6	B6HVX	7435	203	BR6HIX			3419
638	350		B6HS	4510	0,6	B6HVX	7435	203	BR6HIX			3419
638.5 Gespann	350	01.85 -	B6HS	4510	0,5	B6HVX	7435	203	BR6HIX			3419
639	350		B6HS	4510	0,6	B6HVX	7435	203	BR6HIX			3419
640	350		B6HS	4510	0,6	B6HVX	7435	203	BR6HIX			3419
Chopper 350	350		B8HS	5510	0,5	B8HVX	2634	205	BR8HIX			7001
CZ 350	350	84 -	B8HS	5510	0,5	B8HVX	2634	205	BR8HIX			7001
CZ 350 De Luxe	350	- 84	B8HS	5510	0,5	B8HVX	2634	205	BR8HIX			7001
Sabater 350	350		B8HS	5510	0,5	B8HVX	2634	205	BR8HIX			7001
Style 350	350		B8HS	5510	0,5	B8HVX	2634	205	BR8HIX			7001
TS 350	350	09.86 -	B6HS	4510	0,5	B6HVX	7435	203	BR6HIX			3419
Twin Sport	350		B8HS	5510	0,5	B8HVX	2634	205	BR8HIX			7001
GS 360	360	01.74 -12.85	B9HS	5810	0,7	B9HVX	2254					
500 DT Speedway	500				0,5	B9EVX	7254			BR9EIX		3981
500 R	500		D8EA	2120	0,5	D8EVX	2850	216	DR8EIX			6681
500 R Spezial	500				0,5	D8EVX	2850			DR8EIX		6681
Classic 650	650	04 -	DR8EA	7162	0,7	DR8EVX	6354			DR8EIX		6681
Dakar 650	650	06 -	DR8EA	7162	0,7	DR8EVX	6354			DR8EIX		6681
Style 650	650	04 -	DR8EA	7162	0,7	DR8EVX	6354			DR8EIX		6681
JCM												
125 Trail	125		BP6ES	7811	0,7	BP6EVX	5832			BPR6EIX		6637
240 Trail	240		BP7ES	2412	0,5	BP7EVX	7270	206	BPR7EIX			4055
333 Trail	333		BP7ES	2412	0,5	BP7EVX	7270	206	BPR7EIX			4055
KAWASAKI												
AE 50	50	83 -	B8ES	2411	0,8	B8EVX	7051	201	BR8EIX			5044
AE 50	50	- 82	B6ES	7310	0,8	B6EVX	5136					
AR 50	50	93 -	BR8ES	5422	0,8	BR8EVX	1262	207	BR8EIX			5044
AR 50	50	- 82	B6ES	7310	0,8	B6EVX	5136					
AR 50	50	83 - 92	B8ES	2411	0,8	B8EVX	7051	201	BR8EIX			5044
AV 50	50	- 83	D8EA	2120	0,7	D8EVX	2850	216	DR8EIX			6681
AV 50	50	84 -	C6HSA	3228	0,7					CR6HIX		7274
KH 50	50		B6ES	7310	0,8	B6EVX	5136					
KMX 50 (KSR-1)	50	93 -	BR8ES	5422	0,8	BR8EVX	1262	207	BR8EIX			5044
KX 60	60	- 92	B9EG	3530	0,6	B9EGV	5827			BR9EIX		3981
KX 60	60	93 -	BR9EG	3230	0,7	BR9EVX	1265			BR9EIX		3981
KX 65	65		BR10EG	3830	0,6							
AE 80	80	- 82	BP7ES	2412	0,8	BP7EVX	7270	206	BPR7EIX			4055
AE 80	80	83 -	BPR8ES	3923	0,8	BPR8EVX	5573	213				
AN 80	80		C6HSA	3228	0,7					CR6HIX		7274
AR 80	80	83 -	BPR8ES	3923	0,8	BPR8EVX	5573	213				
AR 80	80	- 82	BP7ES	2412	0,8	BP7EVX	7270	206	BPR7EIX			4055
DX 80	80		B8ES	2411	0,8	B8EVX	7051	201	BR8EIX			5044
KD 80	80		B7ES	1111	0,7	B7EVX	6934					
KDX 80	80		B8ES	2411	0,8	B8EVX	7051	201	BR8EIX			5044
KH 80	80		B7ES	1111	0,8	B7EVX	6934					
KMX 80 (KSR-2)	80	93 -	BR8ES	5422	0,8	BR8EVX	1262	207	BR8EIX			5044

					Order No.		Platin 	Order No.	Quick-No. 	Iridium	Order No.
KAWASAKI											
KX 80	80	-	80	B8ES	2411	0,8	B8EVX	7051	201	BR8EIX	5044
KX 80	80	81 -	82	B9ES	2611	0,6	B9EVX	7254	202	BR9EIX	3981
KX 80	80	83 -	91	B9EG	3530	0,6	B9EGV	5827		BR9EIX	3981
KX 80 (KX80S7)	80	97 -		R6252K-105	2741	0,6					
KX 80 (KX80V7)	80	97 -		R6252K-105	2741	0,6					
KX 80 /80-2	80	92 -		R6252K-105	2741	0,6					
KX 85	85	01 -		R6252K-105	2741	0,8					
KX 85-II	85	01 -		R6252K-105	2741	0,8					
KC 90	90			B8ES	2411	0,8	B8EVX	7051	201	BR8EIX	5044
KC 90 A	90			B8ES	2411	0,8	B8EVX	7051	201	BR8EIX	5044
KC 90 C	90			B8HS	5510	0,7	B8HVX	2634	205	BR8HIX	7001
KC 90 D	90			B8HS	5510	0,7	B8HVX	2634	205	BR8HIX	7001
KE 90	90			B8ES	2411	0,8	B8EVX	7051	201	BR8EIX	5044
KH 90	90			B8ES	2411	0,8	B8EVX	7051	201	BR8EIX	5044
KM 90	90			B7HS	5110	0,7	B7HVX	7836	204	BR7HIX	7067
KC 100	100	80 -		B8ES	2411	0,8	B8EVX	7051	201	BR8EIX	5044
KD 100	100			B7HS	5110	0,7	B7HVX	7836	204	BR7HIX	7067
KE 100	100	93 -		BR8ES	5422	0,8	BR8EVX	1262	207	BR8EIX	5044
KE 100	100	01.76 -12.79		B8ES	2411	0,8	B8EVX	7051	201	BR8EIX	5044
KH 100	100			B8ES	2411	0,8	B8EVX	7051	201	BR8EIX	5044
KM 100	100	01.79 -12.81		B7HS	5110	0,7	B7HVX	7836	204	BR7HIX	7067
KV 100	100			B7HS	5110	0,7	B7HVX	7836	204	BR7HIX	7067
KX 100	100	92 -		R6252K-105	2741	0,6					
KAZE 110	110	95 -		C6HSA	3228	0,7				CR6HIX	7274
AR 125	125	01.82 -		BR8ES	5422	0,8	BR8EVX	1262	207	BR8EIX	5044
BN125A Eliminator	125	97 -		CR8E	1275	0,6	CR8EVX	6487	226	CR8EIX	4218
DX 125	125					0,6	B9EVX	7254		BR9EIX	3981
KC 125	125			B6HS	4510	0,7	B6HVX	7435	203	BR6HIX	3419
KD 125	125			B8HS	5510	0,7	B8HVX	2634	205	BR8HIX	7001
KDX 125 SR	125			BR8ES	5422	0,8	BR8EVX	1262	207	BR8EIX	5044
KE 125	125	01.76 -12.83		B8HS	5510	0,8	B8HVX	2634	205	BR8HIX	7001
KH 125	125	93 -		BR8ES	5422	0,8	BR8EVX	1262	207	BR8EIX	5044
KH 125	125	01.77 -12.81		BR8ES	5422	0,8	BR8EVX	1262	207	BR8EIX	5044
KMX 125	125	01.86 -		BR8ES	5422	0,7	BR8EVX	1262	207	BR8EIX	5044
KS 125	125	01.73 -12.76		B8HS	5510	0,7	B8HVX	2634	205	BR8HIX	7001
KX 125	125	91 -	99	R6252K-105	2741	0,6					
KX 125	125	90 -	91	R6254E-105	3949	0,6					
KX 125	125	85 -	90			0,6	B10EVX	7335		BR10EIX	6801
KX 125	125	82 -	84			0,6	B9EVX	7254		BR9EIX	3981
KX 125	125	03 -								BR9EIX	3981
KX 125	125	00 -				0,8	BR9EVX	1265		BR9EIX	3981
KX 125	125	04 -		R6918B-9	2954	0,7					
KX 125 (KX125K4)	125	97 -				0,6	BR9EVX	1265		BR9EIX	3981
KD 175	175			B9HS	5810	0,7	B9HVX	2254			
KDX 175	175	01.80 -12.84				0,6	BR9EVX	1265		BR9EIX	3981
KE 175	175	-	80	B9HS	5810	0,7	B9HVX	2254			
KE 175	175	81 -		B7ES	1111	0,8	B7EVX	6934			
KE 175 B	175			B9HS	5810	0,7	B9HVX	2254			
KE 175 D	175			B7ES	1111	0,8	B7EVX	6934			
KDX 200 H	200	95 -		BR8ES	5422	0,8	BR8EVX	1262	207	BR8EIX	5044
KDX 200	200	93 -	94	BR9ES	5722	0,8	BR9EVX	1265	208	BR9EIX	3981
KMX 200	200	01.88 -	92	BR8ES	5422	0,8	BR8EVX	1262	207	BR8EIX	5044

					Order No.		Platin 	Order No.	Quick-No.	Iridium 	Order No.
KAWASAKI											
Z 200	200	01.77 - 12.79	B8ES	2411	0,8	B8EVX	7051	201	BR8EIX	5044	
BJ 250A (Estrella)	250	93 - 96	DR8ES	5423	0,7	DR8EVX	6354	217	DR8EIX	6681	
BJ 250 C(Estrella)	250	97 -	DR9EA	3437	0,7	DR9EVX	6361	219	DR9EIX	4772	
EL 250/E/F/Eliminator LX/SE	250	89 -	CR8HSA	2086	0,7	CR8HVX	7236		CR8HIX	7669	
EX 250 F (GPX 250 R)	250	93 - 93	C8HA	2168	0,7	C8HVX	2672		CR8HIX	7669	
EX 250 H (ZZ-R 250)	250	93 -	CR8HSA	2086	0,7	CR8HVX	7236		CR8HIX	7669	
GPX 250 R	250		CR8HSA	2086	0,7	CR8HVX	7236		CR8HIX	7669	
GPZ 250 Belt Drive	250		DPR8EA-9	4929	0,9	DPR8EVX-9	2872	221	DPR8EIX-9	2202	
GPZ 250 R	250		CR8HS	7423	0,7	CR8HVX	7236		CR8HIX	7669	
KE 250	250		B8ES	2411	0,8	B8EVX	7051	201	BR8EIX	5044	
KH 250	250	01.73 - 12.79	B9HS	5810	0,7	B9HVX	2254				
KL 250 (A)	250	01.79 - 12.83	BR7ES	5122	0,8	BR7EVX	4556				
KL 250 (KLR 250)	250	01.83 - 91	DPR9EA-9	5329	0,9	DPR9EVX-9	3854	222	DPR9EIX-9	5545	
KLX 250	250	01.80 - 12.84	B7ES	1111	0,8	B7EVX	6934				
KLX 250 (KLX250E)	250	93 -	CR8E	1275	0,8	CR8EVX	6487	226	CR8EIX	4218	
KR-1R	250		BR10ES	4832	0,8	BR10EVX	3788		BR10EIX	6801	
KR-1S	250		BR10ES	4832	0,8	BR10EVX	3788		BR10EIX	6801	
KSF 250 A (SQ)	250	87 -	DPR8EA-9	4929	0,9	DPR8EVX-9	2872	221	DPR8EIX-9	2202	
KT 250	250		B7HS	5110	0,7	B7HVX	7836	204	BR7HIX	7067	
KX 250	250	92 -	R6252E-9	4741	0,9						
KX 250	250	- 91	B9EG	3530	0,6	B9EGV	5827		BR9EIX	3981	
KX 250	250	03 -							BR8EIX	5044	
KX 250 F (KX250T6F)	250	04 -	CR8E	1275	0,8	CR8EVX	6487	226	CR8EIX	4218	
KX 250 (KX250K4)	250	97 -				BR8EVX	1262		BR8EIX	5044	
KX 250 F	250	04 - 05	CR8EB	7784	0,6	CR8EVX	6487		CR8EIX	4218	
KX 250R	250	05 -			0,8	BR8ECMVX	5567				
LTD 250 Belt Drive	250		DR8ES	5423	0,7	DR8EVX	6354	217	DR8EIX	6681	
LX 250	250		BR7ES	5122	0,8	BR7EVX	4556				
Z 250	250		BR7ES	5122	0,8	BR7EVX	4556				
Z 250 A	250	01.80 -	DR8ES	5423	0,7	DR8EVX	6354	217	DR8EIX	6681	
Z 250 B	250		DR8ES	5423	0,7	DR8EVX	6354	217	DR8EIX	6681	
Z 250 Belt Drive	250		DPR8EA-9	4929	0,9	DPR8EVX-9	2872	221	DPR8EIX-9	2202	
Z 250 C	250	01.80 -	B7ES	1111	0,8	B7EVX	6934				
Z 250 D	250		B7ES	1111	0,8	B7EVX	6934				
Z 250 G	250		B7ES	1111	0,8	B7EVX	6934				
Z 250 J	250		DR8ES	5423	0,7	DR8EVX	6354	217	DR8EIX	6681	
Z 250 LTD	250	01.81 -	BR8ES	5422	0,8	BR8EVX	1262	207	BR8EIX	5044	
Z 250 T	250		DPR9EA-9	5329	0,9	DPR9EVX-9	3854	222	DPR9EIX-9	5545	
ZR 250 (Balius)	250	93 -	CR9E	6263	0,8	CR9EVX	5943	227	CR9EIX	3521	
ZX 250 (ZXR 250)	250	93 -	CR9E	6263	0,8	CR9EVX	5943	227	CR9EIX	3521	
KLX 300 R (LX300B5)	300	01 -	CR9E	6263	0,6	CR9EVX	5943	227	CR9EIX	3521	
KVF 300 A&B	300	99 - 02	DR8EA	7162	0,7	DR8EVX	6354		DR8EIX	6681	
MULE 500/ KAF 300 A&B (UV)	300	92 - 96	BPR5ES	7422	0,8	BPR5EVX	4875		BPR5EIX	6597	
GPZ 305 Belt Drive	305	01.83 -	DPR9EA-9	5329	0,9	DPR9EVX-9	3854	222	DPR9EIX-9	5545	
Z 305	305		D8EA	2120	0,7	D8EVX	2850	216	DR8EIX	6681	
EN 400 A	400		DR8ES	5423	0,7	DR8EVX	6354	217	DR8EIX	6681	
GPZ 400	400		DPR9EA-9	5329	0,9	DPR9EVX-9	3854	222	DPR9EIX-9	5545	
GPZ 400 F	400		DPR9EA-9	5329	0,9	DPR9EVX-9	3854	222	DPR9EIX-9	5545	
GPZ 400 F II	400		DPR9EA-9	5329	0,9	DPR9EVX-9	3854	222	DPR9EIX-9	5545	
KH 400	400		B8HS	5510	0,7	B8HVX	2634	205	BR8HIX	7001	
KLE 400	400	93 -	DR8EA	7162	0,7	DR8EVX	6354		DR8EIX	6681	
KX 400	400				0,6	B9EVX	7254		BR9EIX	3981	



Order No.



Gold-Palladium



Platin

Order No.

Quick-No.

Iridium



Order No.

KAWASAKI

LTD 400	400		DR8ES	5423	0,7	DR8EVX	6354	217	DR8EIX	6681
Z 400	400	01.76 - 12.81	BR7ES	5122	0,8	BR7EVX	4556			
Z 400 A/B/C/D/G/H	400		B7ES	1111	0,8	B7EVX	6934			
Z 400 F	400		DPR9EA-9	5329	0,9	DPR9EVX-9	3854	222	DPR9EIX-9	5545
Z 400 F	400	83 -	DR8ES	5423	0,7	DR8EVX	6354	217	DR8EIX	6681
Z 400 F-II	400		DPR9EA-9	5329	0,9	DPR9EVX-9	3854	222	DPR9EIX-9	5545
Z 400 J	400		DR8EA	7162	0,7	DR8EVX	6354		DR8EIX	6681
Z 400 J (I)	400		D8EA	2120	0,7	D8EVX	2850	216	DR8EIX	6681
Z 400 K	400		DR7ES	3123	0,7					
Z 400 LTD	400		BR7ES	5122	0,8	BR7EVX	4556			
Z 400 M	400		DR8EA	7162	0,7	DR8EVX	6354		DR8EIX	6681
ZL 400 (Eliminator 400SE)	400	93 -	DR8ES	5423	0,7	DR8EVX	6354	217	DR8EIX	6681
ZR 400	400	- 83	DR7ES	3123	0,7					
ZR 400	400	84 -	DR8ESL	2923	0,7	DR8EVX	6354	218	DR8EIX	6681
ZR 400-C (Zephyr 400)	400	93 -	DPR9EA-9	5329	0,9	DPR9EVX-9	3854	222	DPR9EIX-9	5545
ZR 400-D (Xanthus)	400	93 -	CR9EK	4548	0,8			230	CR9EIX	3521
ZX 400 (Z 400-F2)	400	93 -	DPR9EA-9	5329	0,9	DPR9EVX-9	3854	222	DPR9EIX-9	5545
ZX 400 (ZXR400R,ZZR400)	400	93 -	CR9EK	4548	0,8			230	CR9EIX	3521
ZXR 400	400		CR9EK	4548	0,8			230	CR9EIX	3521
Z 440	440	01.80 - 12.85	BR7ES	5122	0,8	BR7EVX	4556			
Z 440 H (I)	440		BR7ES	5122	0,8	BR7EVX	4556			
EN 450 A (I)	450		DR8ES	5423	0,7	DR8EVX	6354	217	DR8EIX	6681
KX 450 F (KX450T6F)	450	06 -	CPR8EB-9	6607	0,9					
LTD 450	450	01.85 -	DR8ES	5423	0,7	DR8EVX	6354	217	DR8EIX	6681
Mule 1000 / KAF 450B (UV)	450	90 - 95	D6EA	7512	0,7					
EN 500	500	90 -	DR9EA	3437	0,7	DR9EVX	6361	219	DR9EIX	4772
ER-5 (ER500A1)(ER500C1)	500	97 -	DR9EA	3437	0,7	DR9EVX	6361	219	DR9EIX	4772
ER-5 (ER500B1)(ER500D1)	500	97 -	DR9EA	3437	0,7	DR9EVX	6361	219	DR9EIX	4772
EX 500 (GPZ 500S EN 500)	500	93 -	DR8ES	5423	0,7	DR8EVX	6354	217	DR8EIX	6681
GPX 500 R	500	01.89 -	DR8ES	5423	0,7	DR8EVX	6354	217	DR8EIX	6681
GPZ 500 R	500		DR8ES	5423	0,7	DR8EVX	6354	217	DR8EIX	6681
GPZ 500 S	500		DR8ES	5423	0,7	DR8EVX	6354	217	DR8EIX	6681
GPZ 500 S (EX500E4)	500	97 -	DR9EA	3437	0,7	DR9EVX	6361	219	DR9EIX	4772
GPZ 500 S (EX500D)	500	94 -	DR9EA	3437	0,7	DR9EVX	6361	219	DR9EIX	4772
GPZ 500 S (I)	500		D9EA	2420	0,7	D9EVX	2834		DR9EIX	4772
GRZ 500 S (EX500E)	500		D9EA	2420	0,7	D9EVX	2834		DR9EIX	4772
KH 500	500		B9HS-10	3626	1,0					
KLE 500	500	90 - 04	DR9EA	3437	0,7	DR9EVX	6361	219	DR9EIX	4772
KLE 500	500	05 -	DR9EA	3437	0,7	DR9EVX	6361	219	DR9EIX	4772
KLR 500	500		DPR8EA-9	4929	0,9	DPR8EVX-9	2872	221	DPR8EIX-9	2202
KX 500	500	93 -	BR8EG	3130	0,6					
LE 500 A	500		DR9EA	3437	0,8	DR9EVX	6361	219	DR9EIX	4772
Z 500	500		DR8EA	7162	0,7	DR8EVX	6354		DR8EIX	6681
ZL 500	500		DR8ES	5423	0,7	DR8EVX	6354	217	DR8EIX	6681
ZR 500	500		DR8ESL	2923	0,7	DR8EVX	6354	218	DR8EIX	6681
ZZ-R 500	500		CR9E	6263	0,8	CR9EVX	5943	227	CR9EIX	3521
Mule 2010 / KAF 540C (UV)	540	90 - 93	BPR5ES	7422	0,6	BPR5EVX	4875		BPR5EIX	6597
GPZ 550	550		DPR9EA-9	5329	0,9	DPR9EVX-9	3854	222	DPR9EIX-9	5545
GPZ 550 Unitrack (I)	550		D8EA	2120	0,7	D8EVX	2850	216	DR8EIX	6681
GT 550	550	01.83 -	DR8ES	5423	0,7	DR8EVX	6354	217	DR8EIX	6681
LTD 550	550	01.80 - 12.85	DR8ES	5423	0,7	DR8EVX	6354	217	DR8EIX	6681
Z 550	550		DR8ES	5423	0,7	DR8EVX	6354	217	DR8EIX	6681



Order No.



Gold-Palladium



Platin

Order No.

Quick-No.









Iridium

Order No.

KAWASAKI

Zephyr (ZR550B8)	550	97 -	DR9EA	3437	0,7	DR9EVX	6361	219	DR9EIX	4772
ZR 550 B Zephyr	550	91 -	DR9EA	3437	0,8	DR9EVX	6361	219	DR9EIX	4772
ZX 550 A1	550		DPR9EA-9	5329	0,9	DPR9EVX-9	3854	222	DPR9EIX-9	5545
Eliminator 600 (ZL600B)	600	95 -	DR9EA	3437	0,7	DR9EVX	6361	219	DR9EIX	4772
GPX 600	600		DR8ES	5423	0,8	DR8EVX	6354	217	DR8EIX	6681
GPZ 600	600		DR8ES	5423	0,7	DR8EVX	6354	217	DR8EIX	6681
GPZ 600 R (I)	600		D9EA	2420	0,7	D9EVX	2834		DR9EIX	4772
KL 600	600		DPR8EA-9	4929	0,9	DPR8EVX-9	2872	221	DPR8EIX-9	2202
KL 600 R-Al (I)	600		D8EA	2120	0,7	D8EVX	2850	216	DR8EIX	6681
KLR 600	600	- 84	DR8ES	5423	0,7	DR8EVX	6354	217	DR8EIX	6681
KLR 600	600	85 -	DPR8EA-9	4929	0,9	DPR8EVX-9	2872	221	DPR8EIX-9	2202
KLR 600 EL (I)	600		DP9EA-9	6629	0,9	DP9EVX-9	3331		DP9EIX-9	5545
ZL 600	600	01.86 -	DR8ES	5423	0,7	DR8EVX	6354	217	DR8EIX	6681
ZL 600 (ZL600B/B1)	600	95 -	DR9EA	3437	0,7	DR9EVX	6361	219	DR9EIX	4772
ZX 600 A (I)	600		D9EA	2420	0,7	D9EVX	2834		DR9EIX	4772
ZX-6R Ninja (ZX600F1/F3)	600	95 -	CR9E	6263	0,8	CR9EVX	5943	227	CR9EIX	3521
ZX-6R Ninja (ZX 600 G)	600	98 -	CR9E	6263	0,7	CR9EVX	5943	227	CR9EIX	3521
ZX-6R Ninja (ZX 600 H Kat)	600	98 -	CR9E	6263	0,7	CR9EVX	5943	227	CR9EIX	3521
ZX-6R Ninja (Kat.) (Zx600J1H)	600	00 -	CR9E	6263	0,8	CR9EVX	5943	227	CR9EIX	3521
ZX-6R Ninja (Kat.)	600	03 -	CR9E	6263	0,8	CR9EVX	5943	227	CR9EIX	3521
ZX-6RR	600	04 -	CR9E	6263	0,8	CR9EVX	5943	227	CR9EIX	3521
ZZ-R 600	600	90 -	CR9E	6263	0,8	CR9EVX	5943	227	CR9EIX	3521
ZZ-R 600 (ZX600E9)	600	01 -	CR9E	6263	0,7	CR9EVX	5943	227	CR9EIX	3521
ZZ-R 600 (ZX600E/E5)	600	93 -	CR9E	6263	0,8	CR9EVX	5943	227	CR9EIX	3521
Mule 2510 / KAF 620A&C (UV)	620	93 - 02	BMR2A	7677	0,6					
Mule 3010 / KAF 620E&G (UV)	620	01 -	BPR2ES	2264	0,6					
ZX-6R	636	05 -	CR9E	6263	0,8	CR9EVX	5943	227	CR9EIX	3521
Ninja ZX-6R (ZX636A)	636		CR9E	6263	0,8	CR9EVX	5943	227	CR9EIX	3521
Ninja ZX-6R (ZX636B)	636	03 -	CR9E	6263	0,8	CR9EVX	5943	227	CR9EIX	3521
ZX-6RR	636	05 -	CR9E	6263	0,8	CR9EVX	5943	227	CR9EIX	3521
Ninja ZX-6RR (ZX600K)	636	03 -	CR9E	6263	0,8	CR9EVX	5943	227	CR9EIX	3521
ER-6f (EX650A6F / B6F)	650	06 -			0,9				CR9EIA-9	6289
ER-6n (ER650A6S / B6F)	650	06 -			0,9				CR9EIA-9	6289
KL 650 (KLR 650/Tengai)	650	93 -	DPR8EA-9	4929	0,9	DPR8EVX-9	2872	221	DPR8EIX-9	2202
KLR 650	650	09.86 - 94	DPR8EA-9	4929	0,9	DPR8EVX-9	2872	221	DPR8EIX-9	2202
KLR 650 (KL650C1/C3)	650	95 -	DPR8EA-9	4929	0,9	DPR8EVX-9	2872	221	DPR8EIX-9	2202
KLX 650 (KLX650C)	650	93 -	DPR8EA-9	4929	0,9	DPR8EVX-9	2872	221	DPR8EIX-9	2202
KLX 650 R	650	98 -	DPR8EA-9	4929	0,9	DPR8EVX-9	2872	221	DPR8EIX-9	2202
KLX 650 R (KLX650A)	650	93 - 96	DPR8EA-9	4929	0,9	DPR8EVX-9	2872	221	DPR8EIX-9	2202
Versys 650	650	06 -			0,9				CR9EIA-9	6289
W 650 (EJ650A1)	650	99 -	CR9E	6263	0,8	CR9EVX	5943	227	CR9EIX	3521
Z 650	650		BR7ES	5122	0,8	BR7EVX	4556			
Z 650 F-B	650		B8ES	2411	0,7	B8EVX	7051	201	BR8EIX	5044
LTD 700	700		BR8ES	5422	0,8	BR8EVX	1262	207	BR8EIX	5044
Z 700	700		BR8ES	5422	0,8	BR8EVX	1262	207	BR8EIX	5044
750 Turbo	750	01.73 -12.86			0,6	BR9EVX	1265		BR9EIX	3981
GPX 750 R	750	01.87 -	DR8ES	5423	0,7	DR8EVX	6354	217	DR8EIX	6681
GPX 750 R (I)	750		DR8ESL	2923	0,7	DR8EVX	6354	218	DR8EIX	6681
GPZ 750	750	01.82 -	BR9ES	5722	0,8	BR9EVX	1265	208	BR9EIX	3981
GPZ 750 R	750	01.85 -	DR8ES	5423	0,7	DR8EVX	6354	217	DR8EIX	6681
GT 750	750	01.82 -12.87	BR8ES	5422	0,8	BR8EVX	1262	207	BR8EIX	5044
LTD 750 4 Cyl.	750	01.82 -12.87	BR8ES	5422	0,8	BR8EVX	1262	207	BR8EIX	5044

					Order No.		Gold-Palladium		Order No.	Quick-No.	Iridium		Order No.
KAWASAKI													
VN 750 Twin	750			DPR7EA-9	5129	0,9	DPR7EVX-9	7682	220	DPR7EIX-9	7803		
VN 750 Vulcan	750			DPR7EA-9	5129	0,9	DPR7EVX-9	7682	220	DPR7EIX-9	7803		
Z 2	750			B8ES	2411	0,8	B8EVX	7051	201	BR8EIX	5044		
Z 750	750			BR8ES	5422	0,8	BR8EVX	1262	207	BR8EIX	5044		
Z 750	750	04 -		CR9EK	4548	0,7			230	CR9EIX	3521		
Z 750 (GT750)	750	93 -		DR8ES	5423	0,7	DR8EVX	6354	217	DR8EIX	6681		
Z 750 B	750			BR8ES	5422	0,8	BR8EVX	1262	207	BR8EIX	5044		
Z 750 D	750			B8ES	2411	0,8	B8EVX	7051	201	BR8EIX	5044		
Z 750 E	750			BR8ES	5422	0,8	BR8EVX	1262	207	BR8EIX	5044		
Z 750 GP	750			BR8ES	5422	0,8	BR8EVX	1262	207	BR8EIX	5044		
Z 750 H	750			BR8ES	5422	0,8	BR8EVX	1262	207	BR8EIX	5044		
Z 750 L	750			BR8ES	5422	0,8	BR8EVX	1262	207	BR8EIX	5044		
Z 750 LTD	750			BR8ES	5422	0,8	BR8EVX	1262	207	BR8EIX	5044		
Z 750 LTD Belt Drive	750			BPR6ES	7822	0,8	BPR6EVX	6764		BPR6EIX	6637		
Z 750 LTD Twin.	750			BPR6ES	7822	0,8	BPR6EVX	6764		BPR6EIX	6637		
Z 750 M	750			BR6ES	4922	0,8							
Z 750 S	750			BR6ES	4922	0,8							
ZR-7 (ZR750F1)	750	99 -		DR9EA	3437	0,7	DR9EVX	6361	219	DR9EIX	4772		
ZR 750 C Zephyr	750	91 -	00	DR8ES	5423	0,7	DR8EVX	6354	217	DR8EIX	6681		
ZR 750 S	750	05 -		CR9EK	4548	0,7			230	CR9EIX	3521		
ZR 750 D1/2 Zephyr	750	96 -	00	DR9EA	3437	0,7	DR9EVX	6361	219	DR9EIX	4772		
ZR-7S (ZR750F1)(ZR750-H1)	750	99 -		DR9EA	3437	0,7	DR9EVX	6361	219	DR9EIX	4772		
ZX 750 J	750			CR9E	6263	0,8	CR9EVX	5943	227	CR9EIX	3521		
ZX 750 N1 Ninja ZX-7RR	750	96 -		CR9E	6263	0,8	CR9EVX	5943	227	CR9EIX	3521		
ZX 750 P1/P2 Ninja ZX-7R	750	96 -		CR9E	6263	0,8	CR9EVX	5943	227	CR9EIX	3521		
ZX-7R Ninja (ZX750P6)	750	00 -		CR9E	6263	0,7	CR9EVX	5943	227	CR9EIX	3521		
ZXR 750	750	09.88 -		CR9E	6263	0,8	CR9EVX	5943	227	CR9EIX	3521		
ZXR 750 R	750	90 -		CR9E	6263	0,8	CR9EVX	5943	227	CR9EIX	3521		
ZXR 750 R (ZX750L/M)	750	93 -		CR9E	6263	0,8	CR9EVX	5943	227	CR9EIX	3521		
VN 800 Drifter (VN800C1)	800	99 -	00	CR8E	1275	0,8	CR8EVX	6487	226	CR8EIX	4218		
VN 800 Drifter (VN800E1)	800	01 -		CR7E	4578	0,8			225	CR7EIX	7385		
VN 800 (VN800A)	800	95 -		CR8E	1275	0,8	CR8EVX	6487	226	CR8EIX	4218		
VN 800 (VN800A3)	800	97 -		CR8E	1275	0,8	CR8EVX	6487	226	CR8EIX	4218		
VN 800 B1/B2	800	96 -		CR8E	1275	0,8	CR8EVX	6487	226	CR8EIX	4218		
Vulcan 800	800	95 -		CR8E	1275	0,8	CR8EVX	6487	226	CR8EIX	4218		
GPZ 900 R	900			DR8ES	5423	0,7	DR8EVX	6354	217	DR8EIX	6681		
GPZ 900 R (I)	900			D9EA	2420	0,6	D9EVX	2834		DR9EIX	4772		
Ninja ZX-9R	900	98 -		CR9EK	4548	0,7			230	CR9EIX	3521		
VN 900 Classic	900	06 -		CPR7EA-9									
Z 1	900			B8ES	2411	0,8	B8EVX	7051	201	BR8EIX	5044		
Z 900	900	01.73 -	12.76	B8ES	2411	0,8	B8EVX	7051	201	BR8EIX	5044		
ZX 900 C (Ninja ZX-9R)	900	98 -	99	CR9EK	4548	0,7			230	CR9EIX	3521		
ZX 900 B/B4 (Ninja ZX-9R)	900	94 -	97	CR9EK	4548	0,7			230	CR9EIX	3521		
ZX 900 D (Kat.) (Ninja ZX-9R)	900	98 -	99	CR9EK	4548	0,7			230	CR9EIX	3521		
ZX-9R	900	03 -		CR9EK	4548	0,7			230	CR9EIX	3521		
ZX 900 E1H (Kat.) (Ninja ZX-9R)	900	00 -		CR9EK	4548	0,7			230	CR9EIX	3521		
1000 GTR	1000			DR8ES	5423	0,7	DR8EVX	6354	217	DR8EIX	6681		
1000 GTR (ZG1000A12)	1000	97 -		DR9EA	3437	0,7	DR9EVX	6361	219	DR9EIX	4772		
1000 GTR (ZGT00A)	1000	94 -		DR9EA	3437	0,7	DR9EVX	6361	219	DR9EIX	4772		
1000 GTR (I)	1000			D9EA	2420	0,7	D9EVX	2834		DR9EIX	4772		
A 1000 R1	1000			BR8ES	5422	0,8	BR8EVX	1262	207	BR8EIX	5044		
GPZ 1000 AZ (I)	1000			B8ES	2411	0,7	B8EVX	7051	201	BR8EIX	5044		



Order No.



Gold-Palladium



Platin

Order No.

Quick-No.

Iridium









Order No.







KAWASAKI







GPZ 1000 R (I)	1000		D9EA	2420	0,7	D9EVX	2834		DR9EIX	4772
GPZ 1000 RX	1000		DR8ES	5423	0,7	DR8EVX	6354	217	DR8EIX	6681
GPZ 1000 RX (I)	1000		D9EA	2420	0,7	D9EVX	2834		DR9EIX	4772
KLV 1000	1000	04 -	CR8EK	3478	0,7				CR8EIX	4218
KZ 1000 Police	1000	93 -	BR8ES	5422	0,8	BR8EVX	1262	207	BR8EIX	5044
ST 1000 (I)	1000		B8ES	2411	0,7	B8EVX	7051	201	BR8EIX	5044
Z 1000	1000	- 80	B8ES	2411	0,8	B8EVX	7051	201	BR8EIX	5044
Z 1000	1000	81 -	BR8ES	5422	0,8	BR8EVX	1262	207	BR8EIX	5044
Z 1000	1000	03 -	CR9EK	4548	0,8			230	CR9EIX	3521
Z 1000 ES (I)	1000		B8ES	2411	0,8	B8EVX	7051	201	BR8EIX	5044
Z 1000 J (I)	1000		BR8ES	5422	0,8	BR8EVX	1262	207	BR8EIX	5044
Z1R 1000 (I)	1000		B8ES	2411	0,7	B8EVX	7051	201	BR8EIX	5044
ZL 1000	1000	09.86 -	DR8ES	5423	0,7	DR8EVX	6354	217	DR8EIX	6681
ZX 10	1000	87 - 90	CR9E	6263	0,8	CR9EVX	5943	227	CR9EIX	3521
ZX-10 R Ninja	1000	04 -			0,9				CR9EIA-9	6289
ZX-10 R Ninja (ZX100D6F)	1000	06 -			0,9				CR9EIA-9	6289
ZZR 1100 Kat (ZX1100G)	1052	98 -	CR9E	6263	0,7	CR9EVX	5943	227	CR9EIX	3521
GPZ 1100	1100		BR8ES	5422	0,8	BR8EVX	1262	207	BR8EIX	5044
GPZ 1100 (ZX1100E1E1H)	1100	95 -	CR9EK	4548	0,8			230	CR9EIX	3521
GPZ 1100 ABS (ZX1100F1)	1100	97 -	CR9EK	4548	0,8			230	CR9EIX	3521
LTD 1100	1100		BR8ES	5422	0,8	BR8EVX	1262	207	BR8EIX	5044
Z 1100	1100		BR8ES	5422	0,8	BR8EVX	1262	207	BR8EIX	5044
Zephyr 1100 (ZR1100A)	1100		CR9E	6263	0,8	CR9EVX	5943	227	CR9EIX	3521
Zephyr 1100 (ZRT10A)	1100	92 -	CR9E	6263	0,8	CR9EVX	5943	227	CR9EIX	3521
ZRX 1100 (ZR1100C1)(ZRT10C)	1100	97 - 00	CR9EK	4548	0,8			230	CR9EIX	3521
Zephyr (ZR 1100 B1)	1100	96 -	CR9E	6263	0,8	CR9EVX	5943	227	CR9EIX	3521
ZX 1100 F1	1100	96 -	CR9EK	4548	0,8			230	CR9EIX	3521
ZZR 1100 (ZXT10C)	1100	90 - 92	CR9E	6263	0,8	CR9EVX	5943	227	CR9EIX	3521
ZZR 1100 (ZX1100D5)	1100	97 -	CR9E	6263	0,8	CR9EVX	5943	227	CR9EIX	3521
ZZR 1100 (ZXT10D)	1100	93 - 96	CR9E	6263	0,8	CR9EVX	5943	227	CR9EIX	3521
ZG 1200 (Voyager XII)	1200	93 -	DPR8EA-9	4929	0,9	DPR8EVX-9	2872	221	DPR8EIX-9	2202
ZRX 1200 (ZR1200C1P)	1200	01 -	CR9EK	4548	0,7			230	CR9EIX	3521
ZRX 1200 R (ZR1200C1P)	1200	01 -	CR9EK	4548	0,7			230	CR9EIX	3521
ZRX 1200 S (ZR1200C1P)	1200	01 -	CR9EK	4548	0,7			230	CR9EIX	3521
ZX-12R Ninja (Kat.) (ZX1200A1H)	1200	00 -	CR9EKPA	7785	0,7					
ZZ-R 1200 (ZX1200C1)	1200	02 -	CR9E	6263	0,7	CR9EVX	5943	227	CR9EIX	3521
Z 1300	1300	79 -	B8ES	2411	0,8	B8EVX	7051	201	BR8EIX	5044
Z 1300	1300	80 -	BPR6ES	7822	0,8	BPR6EVX	6764		BPR6EIX	6637
ZZR 1400	1400	06 -			0,9				CR9EIA-9	6289
VN 1500F Classic	1471	98 - 00	DPR5EA-9	2887	0,9					
VN 1500 Mean Streak (P1)	1500	02 -	DPR6EA-9	5531	0,9					
VN 1500 Drifter (VN1500R1)	1500	01 -	DPR6EA-9	5531	0,9					
VN 1500 Drifter (VN1500J1)	1500	99 - 00	DPR5EA-9	2887	0,9					
VN-15 A/B (VN-1500/SE/C/D2)	1500		DPR7EA-9	5129	0,9	DPR7EVX-9	7682	220	DPR7EIX-9	7803
VN 1600 Mean Streak	1600	04 -	DPR6EA-9	5531	0,9					
VN 1600 Classic Tourer	1600	05 -	DPR6EA-9	5531	0,9					
VN 1600 Classic	1600	03 -	DPR6EA-9	5531	0,9					
VN 2000	2053	04 -	IZFR6F-11	4095	1,1					

KRAMER

250	250		B9ES	2611	0,6	B9EVX	7254	202	BR9EIX	3981
-----	-----	--	------	------	-----	-------	------	-----	--------	------

					Order No.		Platin 	Order No.	Quick-No.	Iridium 	Order No.
KREIDLER											
Flory 12yl.4Takt	50	05 -	C7HSA	4629	0,6	C7HVX	4533		CR7HIX	7544	
J 50 Junior	50		B6HS	4510	0,6	B6HVX	7435	203	BR6HIX	3419	
J 51 Junior	50		B6HS	4510	0,6	B6HVX	7435	203	BR6HIX	3419	
K 50	50		B7HS	5110	0,6	B7HVX	7836	204	BR7HIX	7067	
K 51	50		B7HS	5110	0,6	B7HVX	7836	204	BR7HIX	7067	
K 52 Amazone	50		B7HS	5110	0,6	B7HVX	7836	204	BR7HIX	7067	
K 52/2 Amazone	50		B7HS	5110	0,6	B7HVX	7836	204	BR7HIX	7067	
K 53 Florett Motorrad	50		B7HS	5110	0,6	B7HVX	7836	204	BR7HIX	7067	
K 53/1 Florett Mokick	50		B6HS	4510	0,6	B6HVX	7435	203	BR6HIX	3419	
K 54 Florett Motorrad	50		B7HS	5110	0,6	B7HVX	7836	204	BR7HIX	7067	
K 54/0(M) Florett Mokick	50		B6HS	4510	0,6	B6HVX	7435	203	BR6HIX	3419	
K 54/319 Florett LF	50		B6HS	4510	0,5	B6HVX	7435	203	BR6HIX	3419	
K 54/32 D-A(B) Florett LF/LH	50		B6HS	4510	0,6	B6HVX	7435	203	BR6HIX	3419	
K 54/404 Florett RMC	50		B6HS	4510	0,5	B6HVX	7435	203	BR6HIX	3419	
K 54/410 Florett RMC	50		B6HS	4510	0,6	B6HVX	7435	203	BR6HIX	3419	
K 54/42 D Florett RM	50		B6HS	4510	0,5	B6HVX	7435	203	BR6HIX	3419	
K 54/421 Florett RMC	50		B6HS	4510	0,6	B6HVX	7435	203	BR6HIX	3419	
K 54/540 Florett RMC/S	50		B6HS	4510	0,5	B6HVX	7435	203	BR6HIX	3419	
K54/2(A) Florett Super 4	50		B8HS	5510	0,6	B8HVX	2634	205	BR8HIX	7001	
K54/2(B) Florett Motorrad	50		B8HS	5510	0,6	B8HVX	2634	205	BR8HIX	7001	
K54/2(C) Florett Motorrad	50		B8HS	5510	0,6	B8HVX	2634	205	BR8HIX	7001	
K54/3 Florett Motorrad	50		B8HS	5510	0,6	B8HVX	2634	205	BR8HIX	7001	
K54/3 Florett RS	50		B8HS	5510	0,6	B8HVX	2634	205	BR8HIX	7001	
K54/4 Florett Motorrad	50		B8HS	5510	0,6	B8HVX	2634	205	BR8HIX	7001	
K54/5 Florett Super 5/TS	50		B8HS	5510	0,6	B8HVX	2634	205	BR8HIX	7001	
K54/503 Florett RS L	50		B8HS	5510	0,6	B8HVX	2634	205	BR8HIX	7001	
K54/511 Florett RS	50		B8HS	5510	0,6	B8HVX	2634	205	BR8HIX	7001	
K54/512 Mustang / Cross	50		B8HS	5510	0,6	B8HVX	2634	205	BR8HIX	7001	
K54/52 Florett GT	50		B8HS	5510	0,6	B8HVX	2634	205	BR8HIX	7001	
K54/53 (B) Florett RS	50		B8HS	5510	0,6	B8HVX	2634	205	BR8HIX	7001	
K54/54 Florett TM	50		B8HS	5510	0,6	B8HVX	2634	205	BR8HIX	7001	
LF 50	50		B6HS	4510	0,6	B6HVX	7435	203	BR6HIX	3419	
R 50	50		B7HS	5110	0,6	B7HVX	7836	204	BR7HIX	7067	
Enduro	125	00 -	DP7EA-9	5629	0,9	DPR7EVX-9	7682		DPR7EIX-9	7803	
Mustang	125		DR8EA	7162	0,7	DR8EVX	6354		DR8EIX	6681	
KTM											
50 GP	50	10.81 -	B7HS	5110	0,6	B7HVX	7836	204	BR7HIX	7067	
50 GXE	50		B9EG	3530	0,6	B9EGV	5827		BR9EIX	3981	
50 GXR	50				0,6	B9EVX	7254		BR9EIX	3981	
50 SX Pro Junior LC Beta Engine	50	03 -	BR8ECM	3035	0,6	BR8ECMVX	5567				
50 Junior Adventure	50	02 -	BR8HS	4322	0,6	BR8HVX	6265	212	BR8HIX	7001	
50 ME	50	10.81 -	B7HS	5110	0,6	B7HVX	7836	204	BR7HIX	7067	
50 Mini Adventure	50	02 -	BR8HS	4322	0,6	BR8HVX	6265	212	BR8HIX	7001	
50 Mini Adventure GS getrennte Schmierung	50	02 -	BR8HS	4322	0,6	BR8HVX	6265	212	BR8HIX	7001	
50 Mini Adventure	50	01 - 01	B8HS	5510	0,6	B8HVX	2634	205	BR8HIX	7001	
50 MLS	50		B6HS	4510	0,6	B6HVX	7435	203	BR6HIX	3419	
50 MMS	50		B7HS	5110	0,6	B7HVX	7836	204	BR7HIX	7067	
50 MS	50	10.81 -	B6HS	4510	0,6	B6HVX	7435	203	BR6HIX	3419	
50 RSL	50		B7HS	5110	0,6	B7HVX	7836	204	BR7HIX	7067	
50 SX Pro Senior LC	50	03 -	BR8ECM	3035	0,6	BR8ECMVX	5567				

					Order No.		Platin 	Order No.	Quick-No.	Iridium 	Order No.	KTM
50 Senior	50	03 -	BR8ECM	3035	0,6	BR8ECMVX	5567					
50 Senior Adventure	50	02 - 02	BR8HS	4322	0,6	BR8HVX	6265	212	BR8HIX	7001		
50 SX Junior	50	01 - 01	B8HS	5510	0,6	B8HVX	2634	205	BR8HIX	7001		
50 SX Senior	50	01 - 01	B8HS	5510	0,6	B8HVX	2634	205	BR8HIX	7001		
50 SX Senior LC	50	02 - 02	BR10EG	3830	0,6							
50 SX Junior LC	50	02 - 02	BR10EG	3830	0,6							
50 SXR Adventure	50	98 - 01	B8HS	5510	0,6	B8HVX	2634	205	BR8HIX	7001		
50 SXR Pro Senior	50	98 - 01	B8HS	5510	0,6	B8HVX	2634	205	BR8HIX	7001		
50 XR Pro Junior	50	98 - 01	B8HS	5510	0,6	B8HVX	2634	205	BR8HIX	7001		
Bora 25	50	10.81 -	BP6HS	4511	0,6	BP6HVX	4635		BPR6HIX	4085		
Bora 50	50		B6HS	4510	0,6	B6HVX	7435	203	BR6HIX	3419		
Comet	50	09.76 -	B6HS	4510	0,6	B6HVX	7435	203	BR6HIX	3419		
Crazy (CH)	50		BP5HS	4111	0,6							
Foxi	50		B5HS	4210	0,6							
Foxi (DK)	50		B7HS	5110	0,6	B7HVX	7836	204	BR7HIX	7067		
Hobby	50	10.81 -	BP6ES	7811	0,6	BP6EVX	5832		BPR6EIX	6637		
Pony	50	10.81 -	B5HS	4210	0,6							
Pony (CH)	50	10.81 -	B7HS	5110	0,6	B7HVX	7836	204	BR7HIX	7067		
Postmofa	50		BP6ES	7811	0,6	BP6EVX	5832		BPR6EIX	6637		
S5-E	50	99 -	B8HS	5510	0,6	B8HVX	2634	205	BR8HIX	7001		
S5-GS Pro Junior	50	99 -	B8HS	5510	0,6	B8HVX	2634	205	BR8HIX	7001		
S5-GS Pro Senior	50	99 -	B8HS	5510	0,6	B8HVX	2634	205	BR8HIX	7001		
SM 25	50		BP6HS	4511	0,6	BP6HVX	4635		BPR6HIX	4085		
Squadra	50		BP6ES	7811	0,6	BP6EVX	5832		BPR6EIX	6637		
60 SX	60	98 -	R7234-10	5558	0,6							
65 SX	65	98 - 00	R7234-10	5558	0,6							
65 SX	65	01 - 02			0,6	BR10EG	4832					
65 SX Beta Engine	65	03 -	BR8ECM	3035	0,6	BR8ECMVX	5567					
80 Chopper	80		B9HS	5810	0,6	B9HVX	2254					
80 Enduro	80		B10EG	3630	0,6	B10EGV	5927					
80 IGS	80				0,6	B10EGV	5927					
80 IMX	80				0,6	B10EGV	5927					
80 PL	80	06.83 -12.84	B8HS	5510	0,6	B8HVX	2634	205	BR8HIX	7001		
80 RL	80	10.81 -	B8HS	5510	0,6	B8HVX	2634	205	BR8HIX	7001		
80 RLS	80	10.81 -	B9HS	5810	0,6	B9HVX	2254					
80 RLW	80	10.81 -	B9HS	5810	0,6	B9HVX	2254					
80 RS	80	10.81 -	B8HS	5510	0,6	B8HVX	2634	205	BR8HIX	7001		
Bora 80	80	10.81 -	B8HS	5510	0,6	B8HVX	2634	205	BR8HIX	7001		
85 IGS	85				0,6	B10EGV	5927					
85 IMX	85				0,6	B10EGV	5927					
85 SX	85	04 -			0,6	BR10ECMVX	2457					
GS 100	100	08.73 -08.76	B9HCS	2721	0,6							
MC 100	100	08.73 -08.76	B9HCS	2721	0,6							
105 SX	105	04 -			0,7	BR10ECMVX	2457					
125 EGS	125	93 -			0,6	B10EGV	5927					
125 EGS	125	98 -	R6918B-8	4492	0,6							
125 EGS	125	99 -	R6918B-8	4492	0,6							
125 Enduro	125		B10EG	3630	0,6	B10EGV	5927					
125 EXC	125	98 - 99	R6918B-8	4492	0,6							
125 EXC	125	08.97 - 98	R6918B-8	4492	0,6							
125 EXC	125	93 - 95			0,6	B10EGV	5927					
125 EXC	125	96 -08.97			0,6	B10EGV	5927					

					Order No.		Platin 	Order No.	Quick-No. 	Iridium	Order No.
KTM											
125 EXC	125	99 - 00	R6918B-8	4492	0,6						
125 EXC	125	01 -			0,6	BR9EVX	1265		BR9EIX		3981
125 EXE	125	99 -	BR8HS	4322	0,6	BR8HVX	6265	212	BR8HIX		7001
125 LC 2 (Langgewinde)	125	96 - 00	BR9ES	5722	0,6	BR9EVX	1265	208	BR9EIX		3981
125 LC2 (Kurzgewinde)	125	00 -	BR8HS	4322	0,6	BR8HVX	6265	212	BR8HIX		7001
125 MX	125				0,6	B10EGV	5927				
125 Sting	125	98 -	BR8ES	5422	0,7	BR8EVX	1262	207	BR8EIX		5044
125 Supermoto	125	99 -	BR8HS	4322	0,6	BR8HVX	6265	212	BR8HIX		7001
125 SX	125	96-08.97	BR10EG	3830	0,6						
125 SX (98er)	125	08.97 - 98	R6918B-8	4492	0,6						
125 SX	125	93 - 95			0,6	B10EGV	5927				
125 SX	125	02 -			0,6	BR9EVX	1265		BR9EIX		3981
125 SX	125	01 - 01			0,7	BR8EVX	1262		BR8EIX		5044
125 SX	125	99 - 00	R6918B-8	4492	0,6						
125 TXC	125				0,6	B10EGV	5927				
GS 125 12,7 mm	125		B8HS	5510	0,6	B8HVX	2634	205	BR8HIX		7001
GS 125 19,0 mm	125				0,6	B10EGV	5927				
MC 125 12,7 mm	125		B8HS	5510	0,6	B8HVX	2634	205	BR8HIX		7001
MC 125 19,0 mm	125		B9EG	3530	0,6	B9EGV	5827		BR9EIX		3981
MC 125 GP	125		B10HS	2399	0,6	B10HVX	2940				
GS 175	175		B8HS	5510	0,6	B8HVX	2634	205	BR8HIX		7001
MC 175	175		B8HS	5510	0,6	B8HVX	2634	205	BR8HIX		7001
200 EGS	200	98 -	BR8EG	3130	0,6						
200 EGS	200	99 -	BR8EG	3130	0,6						
200 EXC	200	98 - 99	BR8EG	3130	0,6						
200 EXC	200	02 -	BR8EG	3130	0,6						
200 EXC	200	99 - 01	BR9EG	3230	0,6	BR9EVX	1265		BR9EIX		3981
200 MXC	200	99 -	BR8EG	3130	0,6						
200 SX	200	03 -			0,6	BR9EVX	1265		BR9EIX		3981
250 DXC	250				0,6	B9EGV	5827				
250 EGS	250	97 -	BR8ECM	3035	0,6	BR8ECMVX	5567				
250 EGS	250	98 -	BR8ECM	3035	0,6	BR8ECMVX	5567				
250 EGS	250	93 - 95			0,6	B9EGV	5827				
250 EGS	250	99 -	BR8ECM	3035	0,6	BR8ECMVX	5567				
250 Enduro	250		B10EG	3630	0,6	B10EGV	5927				
250 EXC	250	97 - 98	BR8ECM	3035	0,6	BR8ECMVX	5567				
250 EXC / Sixt Days	250	98 - 01	BR8ECM	3035	0,8	BR8ECMVX	5567				
250 EXC	250	96 - 96			0,6	B8EGV	5627				
250 EXC	250	93 - 95			0,6	B9EGV	5827				
250 EXC Enduro Competition	250	03 -	BR7ES	5122	0,6	BR7EVX	4556				
250 EXC Racing GS	250	03 -	DCPR8E	4179	0,6	DCPR8EVX	2265		DCPR8EIX		6546
250 EXC Racing	250	03 -	DCPR8E	4179	0,6	DCPR8EVX	2265		DCPR8EIX		6546
250 EXC Racing / Sixt Days	250	02 - 02	CR8EK	3478	0,6				CR8EIX		4218
250 EXC Racing	250	02 - 02	CR8EK	3478	0,6				CR8EIX		4218
250 MX	250				0,6	B9EGV	5827				
250 SX	250	98 - 99	BR8ECM	3035	0,8	BR8ECMVX	5567				
250 SX	250	93 - 95			0,6	B9EGV	5827				
250 SX	250	96 -	BR8EG	3130	0,6						
250 SX	250	97 - 98	BR8ECM	3035	0,6	BR8ECMVX	5567				
250 SX	250	99 -	BR8ECM	3035	0,6	BR8ECMVX	5567				
250 SX 4Takt	250	05 -	CR9EKB		0,7				CR9EIX		3521
250 SXC	250	99 -	BR8ECM	3035	0,6	BR8ECMVX	5567				



Order No.



Gold-Palladium



Platin

Order No.

Quick-No.







Iridium



Order No.

KTM

250 SXF	250	05 -	CR9EKB		0,7				CR9EIX	3521
250 TXC	250				0,6	B9EGV	5827			
GS 250 12,7 mm	250		B9HS	5810	0,6	B9HVX	2254			
GS 250 19,0 mm	250				0,6	B9EGV	5827			
MC 250 12,7 mm	250		B9HS	5810	0,6	B9HVX	2254			
MC 250 19,0 mm	250		B9EG	3530	0,6	B9EGV	5827	BR9EIX		3981
MC 250 GP 12,7 mm	250		B9HS	5810	0,6	B9HVX	2254			
MC 250 GP 19,0 mm	250		B9EG	3530	0,6	B9EGV	5827	BR9EIX		3981
300 DXC	300	90 - 95			0,6	B9EGV	5827			
300 EGS	300	97 -	BR8ECM	3035	0,6	BR8ECMVX	5567			
300 EGS	300	93 - 95			0,6	B9EGV	5827			
300 EGS	300	99 -	BR8ECM	3035	0,6	BR8ECMVX	5567			
300 EXC	300	93 - 95			0,6	B9EGV	5827			
300 EXC	300	97 - 98	BR8ECM	3035	0,6	BR8ECMVX	5567			
300 EXC	300	96 - 96			0,6	B8EGV	5627			
300 EXC / Sixt Days	300	99 -	BR8ECM	3035	0,6	BR8ECMVX	5567			
300 EXC Enduro Competition	300	03 -	BR7ES	5122	0,6	BR7EVX	4556			
300 GS	300	90 - 95			0,6	B9EGV	5827			
300 LC (I)	300		B10EG	3630	0,6	B10EGV	5927			
300 MX	300	- 95			0,6	B9EGV	5827			
300 MXC	300	97 - 02	BR8ECM	3035	0,6	BR8ECMVX	5567			
300 MXC	300	03 -	BR7ES	5122	0,6	BR7EVX	4556			
300 SX	300	93 - 95			0,6	B9EGV	5827			
300 SX	300	99 -	BR8ECM	3035	0,6	BR8ECMVX	5567			
300 TXC	300	- 95			0,6	B9EGV	5827			
350 GS	350				0,6	B9EVX	7254	BR9EIX		3981
350 MX	350				0,6	B9EVX	7254	BR9EIX		3981
LC4 18kW	350	- 93	D8EA	2120	0,6	D8EVX	2850	216	DR8EIX	6681
LC4 30kW	350	- 93	D8EA	2120	0,6	D8EVX	2850	216	DR8EIX	6681
LC4 350 EGS	350	93 -	D8EA	2120	0,6	D8EVX	2850	216	DR8EIX	6681
LC4 350 EXC	350	93 -	D8EA	2120	0,6	D8EVX	2850	216	DR8EIX	6681
360 EGS	360	97 -	BR8ECM	3035	0,6	BR8ECMVX	5567			
360 EXC	360	97 -	BR8ECM	3035	0,6	BR8ECMVX	5567			
360 MXC	360	97 -	BR8ECM	3035	0,6	BR8ECMVX	5567			
360 SX	360	96 -	BR8EG	3130	0,6					
360 SX	360	97 -	BR8ECM	3035	0,6	BR8ECMVX	5567			
380 Enduro	380	98 -	BR8ECM	3035	0,6	BR8ECMVX	5567			
380 EGS	380	98 -	BR8ECM	3035	0,8	BR8ECMVX	5567			
380 EGS	380	99 -	BR8ECM	3035	0,6	BR8ECMVX	5567			
380 EXC	380	98 -	BR8ECM	3035	0,8	BR8ECMVX	5567			
380 SX	380	99 -	BR8ECM	3035	0,6	BR8ECMVX	5567			
390	390		B9EG	3530	0,6	B9EGV	5827	BR9EIX		3981
400 Enduro-E	400	98 -	D8EA	2120	0,6	D8EVX	2850	216	DR8EIX	6681
400 EGS	400	97 -	D8EA	2120	0,6	D8EVX	2850	216	DR8EIX	6681
400 EGS-E	400	97 -	DR8EA	7162	0,6	DR8EVX	6354		DR8EIX	6681
400 EXC Racing	400	99-04.02	CR8EK	3478	0,7				CR8EIX	4218
400 EXC Racing	400	03 -	DCPR8E	4179	0,6	DCPR8EVX	2265		DCPR8EIX	6546
400 EXC Racing	400	05.02 -	DCPR8E	4179	0,6	DCPR8EVX	2265		DCPR8EIX	6546
400 LC4-E	400	99-04.02	DR8EA	7162	0,7	DR8EVX	6354		DR8EIX	6681
400 LC4	400	99-04.02	DR8EA	7162	0,7	DR8EVX	6354		DR8EIX	6681
400 LS-E	400	97-04.02	DR8EA	7162	0,6	DR8EVX	6354		DR8EIX	6681
400 SC	400	96 -	D8EA	2120	0,6	D8EVX	2850	216	DR8EIX	6681

					Order No.		Gold-Palladium	Platin 	Order No.	Quick-No.	Iridium 	Order No.
KTM												
400 SC	400	98 -	D8EA	2120	0,6	D8EVX	2850	216	DR8EIX	6681		
400 Supercompetition	400	97 -	D8EA	2120	0,6	D8EVX	2850	216	DR8EIX	6681		
400 SX Racing / Six Days	400	99-04.02	CR8EK	3478	0,7				CR8EIX	4218		
400 SX	400	98-04.02	D8EA	2120	0,6	D8EVX	2850	216	DR8EIX	6681		
400 SX Racing	400	05.02 -	DCPR8E	4179	0,6	DCPR8EVX	2265		DCPR8EIX	6546		
400 SXC	400	98-04.02	D8EA	2120	0,6	D8EVX	2850	216	DR8EIX	6681		
400 SXC	400	99-04.02	D8EA	2120	0,6	D8EVX	2850	216	DR8EIX	6681		
400 SXC 20kW	400	99-04.02	D8EA	2120	0,6	D8EVX	2850	216	DR8EIX	6681		
GS 400	400		B9HS	5810	0,6	B9HVX	2254					
LC4- E 400 Enduro	400	01 -	DR8EA	7162	0,7	DR8EVX	6354		DR8EIX	6681		
LC4 400	400	98 -	DR8EA	7162	0,7	DR8EVX	6354		DR8EIX	6681		
LC4 400 EGS	400	93 -	D8EA	2120	0,6	D8EVX	2850	216	DR8EIX	6681		
LC4 400 EXC	400	93 -	D8EA	2120	0,6	D8EVX	2850	216	DR8EIX	6681		
LC4 Competition	400	98 -	DR8EA	7162	0,7	DR8EVX	6354		DR8EIX	6681		
LC4-E	400	05.02 -	DCPR8E	4179	0,6	DCPR8EVX	2265		DCPR8EIX	6546		
MC 400	400		B9HS	5810	0,6	B9HVX	2254					
MC 400 GP	400		B9HS	5810	0,6	B9HVX	2254					
420	420		B9EG	3530	0,6	B9EGV	5827		BR9EIX	3981		
440 EXC	440	94 -			0,6	B85EGV	7498					
440 SX	440	94 -			0,6	B85EGV	7498					
450 EXC Racing	450	03 -	DCPR8E	4179	0,6	DCPR8EVX	2265		DCPR8EIX	6546		
450 EXC Racing GS	450	03 -	DCPR8E	4179	0,6	DCPR8EVX	2265		DCPR8EIX	6546		
450 MXC Dessert	450	03 -	DCPR8E	4179	0,6	DCPR8EVX	2265		DCPR8EIX	6546		
450 MXC GS	450	03 -	DCPR8E	4179	0,6	DCPR8EVX	2265		DCPR8EIX	6546		
450 SMR	450	05 -	DCPR8E	4179	0,6	DCPR8EVX	2265		DCPR8EIX	6546		
450 SX Racing	450	03 -	DCPR8E	4179	0,6	DCPR8EVX	2265		DCPR8EIX	6546		
495	495		B9EG	3530	0,6	B9EGV	5827		BR9EIX	3981		
500 4 TGS	500		DP9EA-9	6629	0,9	DP9EVX-9	3331		DPR9EIX-9	5545		
500 4 TXC	500		DP9EA-9	6629	0,9	DP9EVX-9	3331		DPR9EIX-9	5545		
500 DXC	500		B9ES	2611	0,6	B9EVX	7254	202	BR9EIX	3981		
500 EXC	500		B9ES	2611	0,6	B9EVX	7254	202	BR9EIX	3981		
500 MX	500				0,6	B9EVX	7254		BR9EIX	3981		
500 SX	500	93 -	B10ES	7928	0,6	B10EVX	7335		BR10EIX	6801		
GS 500 2Stroke	500		B10EG	3630	0,6	B10EGV	5927					
GS 500 4Stroke	500		D8EA	2120	0,6	D8EVX	2850	216	DR8EIX	6681		
MC 500 2Stroke	500		B10EG	3630	0,6	B10EGV	5927					
MC 500 4Stroke	500		D8EA	2120	0,6	D8EVX	2850	216	DR8EIX	6681		
520 EXC Racing / Six Days	520	99-04.02	CR8EK	3478	0,7				CR8EIX	4218		
520 EXC Racing	520	05.02 -	DCPR8E	4179	0,6	DCPR8EVX	2265		DCPR8EIX	6546		
520 SX Racing	520	99-04.02	CR8EK	3478	0,7				CR8EIX	4218		
520 SX Racing	520	05.02 -	DCPR8E	4179	0,6	DCPR8EVX	2265		DCPR8EIX	6546		
525 EXC Racing	525	03 -	DCPR8E	4179	0,6	DCPR8EVX	2265		DCPR8EIX	6546		
525 EXC Racing GS	525	03 -	DCPR8E	4179	0,6	DCPR8EVX	2265		DCPR8EIX	6546		
525 MXC	525	03 -	DCPR8E	4179	0,6	DCPR8EVX	2265		DCPR8EIX	6546		
525 MXC Desert Racing	525	05 -	DCPR8E	4179	0,6	DCPR8EVX	2265		DCPR8EIX	6546		
525 SMR	525	05 -	DCPR8E	4179	0,6	DCPR8EVX	2265		DCPR8EIX	6546		
525 SX Racing	525	03 -	DCPR8E	4179	0,6	DCPR8EVX	2265		DCPR8EIX	6546		
540 DXC	540				0,6	B10EGV	5927					
540 MX	540		B9ES	2611	0,6	B9EVX	7254	202	BR9EIX	3981		
540 SXC	540	98 -	D8EA	2120	0,6	D8EVX	2850	216	DR8EIX	6681		
540 SXC	540	99 -	D8EA	2120	0,6	D8EVX	2850	216	DR8EIX	6681		
540 SXC 20kW	540	99 -	D8EA	2120	0,6	D8EVX	2850	216	DR8EIX	6681		



Order No.



Gold-Palladium



Platin

Order No.

Quick-No.



Iridium

Order No.

KTM

540 SXS Racing	540	02 -	CR8EK	3478	0,7					CR8EIX	4218
600 4 TGS	600		DP9EA-9	6629	0,9	DP9EVX-9	3331			DPR8EIX-9	5545
600 4 TMX	600		DP9EA-9	6629	0,9	DP9EVX-9	3331			DPR8EIX-9	5545
600 4 TXC	600		DP9EA-9	6629	0,9	DP9EVX-9	3331			DPR8EIX-9	5545
600 Country	600		D8EA	2120	0,6	D8EVX	2850	216		DR8EIX	6681
600 Enduro	600		D8EA	2120	0,6	D8EVX	2850	216		DR8EIX	6681
600 MX	600		D8EA	2120	0,6	D8EVX	2850	216		DR8EIX	6681
LC4 Enduro 17kW	600	- 87	D8EA	2120	0,6	D8EVX	2850	216		DR8EIX	6681
LC4 Enduro 36kW	600	- 87	D8EA	2120	0,6	D8EVX	2850	216		DR8EIX	6681
LC4 600 EGS	600	93 -	D8EA	2120	0,6	D8EVX	2850	216		DR8EIX	6681
LC4 600 EXC	600	93 -	D8EA	2120	0,6	D8EVX	2850	216		DR8EIX	6681
620 Duke	609	94 -	D8EA	2120	0,6	D8EVX	2850	216		DR8EIX	6681
LC4 620 Supercompetition	609	01-04.02	DR8EA	7162	0,7	DR8EVX	6354			DR8EIX	6681
LC4 620 SC Supermoto	609	01-04.02	DR8EA	7162	0,7	DR8EVX	6354			DR8EIX	6681
LC4 612 EGS	612	93 -	D8EA	2120	0,6	D8EVX	2850	216		DR8EIX	6681
LC4 612 EXC	612	93 -	D8EA	2120	0,6	D8EVX	2850	216		DR8EIX	6681
620 Duke-E	620	97 -	DR8EA	7162	0,6	DR8EVX	6354			DR8EIX	6681
620 EGS	620	97 -	D8EA	2120	0,6	D8EVX	2850	216		DR8EIX	6681
620 EGS-E	620	97 -	DR8EA	7162	0,6	DR8EVX	6354			DR8EIX	6681
620 LS4 Rally	620	97 -	D8EA	2120	0,6	D8EVX	2850	216		DR8EIX	6681
620 LS-E	620	97 -	DR8EA	7162	0,6	DR8EVX	6354			DR8EIX	6681
620 SC	620	96 -	D8EA	2120	0,6	D8EVX	2850	216		DR8EIX	6681
620 SC	620	98 -	D8EA	2120	0,6	D8EVX	2850	216		DR8EIX	6681
620 Supercompetition	620	97-04.02	D8EA	2120	0,6	D8EVX	2850	216		DR8EIX	6681
620 SX	620	96 -	D8EA	2120	0,6	D8EVX	2850	216		DR8EIX	6681
620 SX	620	99 -	D8EA	2120	0,6	D8EVX	2850	216		DR8EIX	6681
LC4 620 EGS	620	94 -	D8EA	2120	0,6	D8EVX	2850	216		DR8EIX	6681
LC4 620 EXC	620	94 -	D8EA	2120	0,6	D8EVX	2850	216		DR8EIX	6681
LC4 620 SX	620	94 -	D8EA	2120	0,6	D8EVX	2850	216		DR8EIX	6681
LC4 Super Competition	620	00-04.02	DPR8EA-9	4929	0,9	DPR8EVX-9	2872	221		DPR8EIX-9	2202
LC 4 Supercopetition Supermoto	620	05.02 -	DCPR8E	4179	0,6	DCPR8EVX	2265			DCPR8EIX	6546
Supermoto Competition 620	620	98 - 00	D8EA	2120	0,6	D8EVX	2850	216		DR8EIX	6681
625 SC	625	02 -	DPR8EA-9	4929	0,9	DPR8EVX-9	2872	221		DPR8EIX-9	2202
625 SMC	625	05 -	DCPR8E	4179	0,6	DCPR8EVX	2265			DCPR8EIX	6546
625 SXC Hard Enduro	625	03 -	DCPR8E	4179	0,6	DCPR8EVX	2265			DCPR8EIX	6546
625 SXC Super Moto	625	02 -	DCPR8E	4179	0,6	DCPR8EVX	2265			DCPR8EIX	6546
640 Duke	625	05 -	DCPR8E	4179	0,6	DCPR8EVX	2265			DCPR8EIX	6546
640 Duke 2	625	02-04.02	DPR8EA-9	4929	0,9	DPR8EVX-9	2872	221		DPR8EIX-9	2202
640 LC4 SM	625	05 -	DCPR8E	4179	0,6	DCPR8EVX	2265			DCPR8EIX	6546
640 Supermoto Spezial Edition	625	03 -	DCPR8E	4179	0,6	DCPR8EVX	2265			DCPR8EIX	6546
Adventure R 640	625	98 - 01	DR8EA	7162	0,7	DR8EVX	6354			DR8EIX	6681
Duke 2	625	00-04.02	DPR8EA-9	4929	0,9	DPR8EVX-9	2872	221		DPR8EIX-9	2202
Duke 640	625	98 - 01	DR8EA	7162	0,7	DR8EVX	6354			DR8EIX	6681
Duke II	625	05.02 -	DCPR8E	4179	0,6	DCPR8EVX	2265			DCPR8EIX	6546
Duke II	625	99 - 01	DR8EA	7162	0,7	DR8EVX	6354			DR8EIX	6681
LC 4 E Supermoto	625	05.02 - 02	DCPR8E	4179	0,6	DCPR8EVX	2265			DCPR8EIX	6546
LC4 640	625	98 - 00	DR8EA	7162	0,7	DR8EVX	6354			DR8EIX	6681
LC4 Adventure	625	00 - 00	DPR8EA-9	4929	0,9	DPR8EVX-9	2872	221		DPR8EIX-9	2202
LC4- E	625	00 - 00	DPR8EA-9	4929	0,9	DPR8EVX-9	2872	221		DPR8EIX-9	2202
LC4 640 Duke II	625	03 -	DCPR8E	4179	0,6	DCPR8EVX	2265			DCPR8EIX	6546
LC4- E Supermoto	625	00 - 00	DPR8EA-9	4929	0,9	DPR8EVX-9	2872	221		DPR8EIX-9	2202
LC4 Prestige Supermoto	625	03 -	DCPR8E	4179	0,6	DCPR8EVX	2265			DCPR8EIX	6546

					Order No.		Gold-Palladium		Platin	Order No.	Quick-No.		Iridium	Order No.
KTM														
LC 4 Adventure R	625	05.02 -	DCPR8E	4179	0,6	DCPR8EVX	2265					DCPR8EIX	6546	
LC4-640 Hard Enduro	625	03 -	DCPR8E	4179	0,6	DCPR8EVX	2265					DCPR8EIX	6546	
640 LC4	625	02-04.02	DPR8EA-9	4929	0,9	DPR8EVX-9	2872	221				DPR8EIX-9	2202	
640 LC4 Adventure	625	02-04.02	DPR8EA-9	4929	0,9	DPR8EVX-9	2872	221				DPR8EIX-9	2202	
640 LC4 Super Moto	625	02-04.02	DPR8EA-9	4929	0,9	DPR8EVX-9	2872	221				DPR8EIX-9	2202	
640 LC4-E SM Prestige	625	02-04.02	DPR8EA-9	4929	0,9	DPR8EVX-9	2872	221				DPR8EIX-9	2202	
640 LC4	625	99-01	DR8EA	7162	0,7	DR8EVX	6354					DR8EIX	6681	
LC4- 640 Adventure	625	01-04.02	DR8EA	7162	0,7	DR8EVX	6354					DR8EIX	6681	
LC4- E 640 Enduro	625	01 - 01	DR8EA	7162	0,7	DR8EVX	6354					DR8EIX	6681	
LC 4 E	625	05.02 -	DCPR8E	4179	0,6	DCPR8EVX	2265					DCPR8EIX	6546	
640 LC4-E Six Days	625	02-04.02	DPR8EA-9	4929	0,9	DPR8EVX-9	2872	221				DPR8EIX-9	2202	
LC4- E 640 Supermoto	625	01 - 01	DR8EA	7162	0,7	DR8EVX	6354					DR8EIX	6681	
660 Rallye	650	02-04.02	DR9EA	3437	0,6	DR9EVX	6361	219				DR9EIX	4772	
660 Super Moto Factory Replica	650	02 -	DR9EA	3437	0,6	DR9EVX	6361	219				DR9EIX	4772	
LC4 660	650	03 -	DR9EA	3437	0,6	DR9EVX	6361	219				DR9EIX	4772	
660 LC4 Rallye	650	99 - 01	DR8EA	7162	0,6	DR8EVX	6354					DR8EIX	6681	
Rallye	650	00 - 01	DPR8EA-9	4929	0,9	DPR8EVX-9	2872	221				DPR8EIX-9	2202	
Rallye	650	05.02 - 02	DCPR8E	4179	0,6	DCPR8EVX	2265					DCPR8EIX	6546	
660 SMC	660	05 -	DCPR8E	4179	0,6	DCPR8EVX	2265					DCPR8EIX	6546	
950 Supermoto	950	05 -	CR8EK	3478	0,7							CR8EIX	4218	
950 Super Enduro	950	06 -	CR8EK	3478	0,7							CR8EIX	4218	
950 Adventure	950	03 -	CR8EK	3478	0,7							CR8EIX	4218	
950 Adventure S	950	03 -	CR8EK	3478	0,7							CR8EIX	4218	
LC8 950 Rally	950	03 -	CR8EK	3478	0,7							CR8EIX	4218	
990 Adventure S	1000	06 -	DCPR8E	4179	0,6	DCPR8EVX	2265					DCPR8EIX	6546	
990 Duke	1000	09.04 -	DCPR8E	4179	0,6	DCPR8EVX	2265					DCPR8EIX	6546	
990 Superduke	1000	05 -	DCPR8E	4179	0,6	DCPR8EVX	2265					DCPR8EIX	6546	
KUANG YANG														
GS7E - Movie	50		BP6HSA	1046	0,6							BPR6HIX	4085	
KA 50	50		BP6HSA	1046	0,6							BPR6HIX	4085	
KA 50G	50		BP6HSA	1046	0,6							BPR6HIX	4085	
KYMCO														
Tomos TX 50	50	01 -	B6HS	4510	0,6	B6HVX	7435	203				BR6HIX	3419	
CK 125	125	04 -	DR8EA	7162	0,7	DR8EVX	6354					DR8EIX	6681	
Hipster 125 2Ventil	125		DR8EA	7162	0,7	DR8EVX	6354					DR8EIX	6681	
Hipster 125 4Takt/4Ventil	125	01 -	CR8E	1275	0,6	CR8EVX	6487	226				CR8EIX	4218	
Pulsar 125 4Takt	125	01 -	DR8EA	7162	0,7	DR8EVX	6354					DR8EIX	6681	
Stryker 125	125	99 -	DR8EA	7162	0,7	DR8EVX	6354					DR8EIX	6681	
Stryker 125 II	125	02 -	DR8EA	7162	0,7	DR8EVX	6354					DR8EIX	6681	
Zing 125	125	99 -	DR8EA	7162	0,7	DR8EVX	6354					DR8EIX	6681	
Venox 250 4Takt	250	01 -	DPR7EA-9	5129	0,9	DPR7EVX-9	7682	220				DPR7EIX-9	7803	
LAMBRETTA														
3V77/4V/5V	50		B6HS	4510	0,5	B6HVX	7435	203				BR6HIX	3419	
Puma Cross,Trial	50		B6HS	4510	0,5	B6HVX	7435	203				BR6HIX	3419	
125,Lince,Linea,SX	125		B7ES	1111	0,5	B7EVX	6934							
150 GP	150		B7ES	1111	0,5	B7EVX	6934							
Spezial 150	150		B7ES	1111	0,5	B7EVX	6934							
200 GP	200		B7ES	1111	0,5	B7EVX	6934							
200,Jet,Lince,Mensa-Expres	200		B7ES	1111	0,5	B7EVX	6934							



Order No.



Gold-Palladium



Platin

Order No.

Quick-No.

Iridium









Order No.







LAMBRETTA







Pony,SX	200		B7ES	1111	0,5	B7EVX	6934			
LAVERDA										
CU125 Ride, GS125 Lesmo	125		B8ES	2411	0,5	B8EVX	7051	201	BR8EIX	5044
Custom, Strada	125		B9ES	2611	0,5	B9EVX	7254	202	BR9EIX	3981
LB125 Uno	125		B8ES	2411	0,5	B8EVX	7051	201	BR8EIX	5044
350 Alpino	350		D9EA	2420	0,5	D9EVX	2834		DR9EIX	4772
500 Alpino/Montjuich	500		D9EA	2420	0,5	D9EVX	2834		DR9EIX	4772
OR600 Atlas	600		D8EA	2120	0,6	D8EVX	2850	216	DR8EIX	6681
650 Ghost	668	96 -	DCPR9E	2641	0,6	DCPR9EVX	6436		DCPR9EIX	2316
650 Ghost Strike	668	96 -	DCPR9E	2641	0,6	DCPR9EVX	6436		DCPR9EIX	2316
650 Ghost Legend	668	96 -	DCPR9E	2641	0,6	DCPR9EVX	6436		DCPR9EIX	2316
650 Sport	668	95 -	DCPR9E	2641	0,6	DCPR9EVX	6436		DCPR9EIX	2316
668	668	96 -	DCPR9E	2641	0,6	DCPR9EVX	6436		DCPR9EIX	2316
668	668	97 -	DCPR9E	2641	0,6	DCPR9EVX	6436		DCPR9EIX	2316
668	668		DCPR9E	2641	0,6	DCPR9EVX	6436		DCPR9EIX	2316
750 S Formula	750	98 -	DCPR9E	2641	0,6	DCPR9EVX	6436		DCPR9EIX	2316
750/GS/GT/S/SFC/SF-2D	750		BP8ES	2912	0,5	BP8EVX	2671			
770 GTL	750		BP7ES	2412	0,5	BP7EVX	7270	206	BPR7EIX	4055
SF,SF Competizione/SS	750		B10EGV	5927	0,5	B10EVX	7335			
SF2-10, SF3	750		B8ES	2411	0,5	B8EVX	7051	201	BR8EIX	5044
1000 RGS	1000		B8ES	2411	0,6	B8EVX	7051	201	BR8EIX	5044
1000/Jarama/Jota/SC/CE/CL	1000		B8ES	2411	0,6	B8EVX	7051	201	BR8EIX	5044
1200/Mirage/TS	1200		B8ES	2411	0,6	B8EVX	7051	201	BR8EIX	5044







LEM







2001 Bay	50		BP6ES	7811	0,5	BP6EVX	5832		BPR6EIX	6637
2001 Matic	50		BP6ES	7811	0,5	BP6EVX	5832		BPR6EIX	6637
2001 Variant	50		BP6ES	7811	0,5	BP6EVX	5832		BPR6EIX	6637
Cayman	50		B7HS	5110	0,5	B7HVX	7836	204	BR7HIX	7067
Cayman LC	50		B7HS	5110	0,5	B7HVX	7836	204	BR7HIX	7067
Chembol Form	50		B6ES	7310	0,5	B6EVX	5136			
Chembol Raid	50		B6ES	7310	0,5	B6EVX	5136			
Cinno Corsa 8 / 10	50		B6HS	4510	0,5	B6HVX	7435	203	BR6HIX	3419
Condor	50		B7HS	5110	0,5	B7HVX	7836	204	BR7HIX	7067
Convert	50		B5HS	4210	0,5					
CR 3	50	97 -	B7HS	5110	0,5	B7HVX	7836	204	BR7HIX	7067
L 2	50		B7HS	5110	0,5	B7HVX	7836	204	BR7HIX	7067
LX 1	50		B8HS	5510	0,6	B8HVX	2634	205	BR8HIX	7001
LX 2	50	97 -	B7HS	5110	0,5	B7HVX	7836	204	BR7HIX	7067
LX 2-S Sport	50	97 -	B7HS	5110	0,5	B7HVX	7836	204	BR7HIX	7067
LX 2-SR	50		B7HS	5110	0,5	B7HVX	7836	204	BR7HIX	7067
LX 4 New	50		B9ES	2611	0,6	B9EVX	7254	202	BR9EIX	3981
Piesse	50		B5HS	4210	0,5					
Pizeta	50		B5HS	4210	0,5					
Pratikal Kit SL	50		B5HS	4210	0,5					
R 2 Air	50					B10EGV	5927			
R 3 Air	50					B10EGV	5927			
R 3 Usa	50					B10EGV	5927			
SK 6	50		B7HS	5110	0,5	B7HVX	7836	204	BR7HIX	7067
SM 2	50		B7HS	5110	0,5	B7HVX	7836	204	BR7HIX	7067
SM 3	50					B10EGV	5927			







					Order No.		Platin 	Order No.	Quick-No.	Iridium 	Order No.
LEM											
Stratos			B6ES	7310	0,5	B6EVX	5136				
Stratos Matic	50		B5HS	4210	0,5						
MAGNI											
Sfida	1000		BP6ES	7811	0,6	BP6EVX	5832			BPR6EIX	6637
MAICO											
MC 125-490		71 - 97			0,6	B9EVX	7254			BR9EIX	3981
GS 125-490		71 - 97			0,6	B9EVX	7254			BR9EIX	3981
GS 125-360		- 70			0,7	B9HVX	2264				
MC 125-360		- 70			0,7	B9HVX	2264				
MD 50	50				0,7	B9HVX	2264				
Wiesel	50				0,7	B6HVX	7435			BR6HIX	3419
Mofa	50				0,7	B6HVX	7435			BR6HIX	3419
MD 125	125				0,7	B9HVX	2264				
M 125 / 126	125				0,7	B6HVX	7435			BR6HIX	3419
GS 125	125		B9ES	2611	0,5	B9EVX	7254	202		BR9EIX	3981
MC 125	125		B9ES	2611	0,5	B9EVX	7254	202		BR9EIX	3981
SG 125	125		B9ES	2611	0,5	B9EVX	7254	202		BR9EIX	3981
M 150 / 151	150				0,7	B6HVX	7435			BR6HIX	3419
Macomobil MB 150	150				0,7	B7HVX	7736			BR7HIX	7067
M 175	175				0,7	B7HVX	7736			BR7HIX	7067
Maicoletta 175	175				0,7	B8HVX	2634			BR8HIX	7001
M 175 SS	175				0,7	B9HVX	2264				
M 200	200				0,7	B7HVX	7736			BR7HIX	7067
Macomobil MB 2000	200				0,7	B7HVX	7736			BR7HIX	7067
M 250 S / 2 Blizzard	250				0,7	B8HVX	2634			BR8HIX	7001
M 250	250				0,7	B8HVX	2634			BR8HIX	7001
M 250 B (Behördenausführung)	250				0,7	B8HVX	2634			BR8HIX	7001
Maicoletta 250	250				0,7	B8HVX	2634			BR8HIX	7001
M 250 S / 1 Blizzard	250				0,7	B7HVX	7736			BR7HIX	7067
M 250 SS	250				0,7	B9HVX	2264				
M 250 M Military	250				0,6	B9EVX	7254			BR9EIX	3981
MD 250	250				0,6	B9EVX	7254			BR9EIX	3981
MD 250 wk	250				0,6	B9EVX	7254			BR9EIX	3981
250	250	94 -	B9ES	2611	0,5	B9EVX	7254	202		BR9EIX	3981
GM Star 250	250		B9ES	2611	0,5	B9EVX	7254	202		BR9EIX	3981
GM Star E 250	250		B9ES	2611	0,5	B9EVX	7254	202		BR9EIX	3981
GS 250	250		B9ES	2611	0,5	B9EVX	7254	202		BR9EIX	3981
GSE 250	250	-05.83	B9ES	2611	0,5	B9EVX	7254	202		BR9EIX	3981
MC 250	250		B9ES	2611	0,5	B9EVX	7254	202		BR9EIX	3981
M 277	277				0,7	B8HVX	2634			BR8HIX	7001
Maicoletta 277	277				0,7	B8HVX	2634			BR8HIX	7001
320	320	94 -	B9ES	2611	0,6	B9EVX	7254	202		BR9EIX	3981
Taifun 350	350				0,7	B8HVX	2634			BR8HIX	7001
Taifun 400	400				0,7	B8HVX	2634			BR8HIX	7001
GS 400	400	01.74 -05.83	B9ES	2611	0,5	B9EVX	7254	202		BR9EIX	3981
MC 400	400		B9ES	2611	0,5	B9EVX	7254	202		BR9EIX	3981
440	440	94 -	B9ES	2611	0,6	B9EVX	7254	202		BR9EIX	3981
GSE 490	490	-05.83	B9ES	2611	0,5	B9EVX	7254	202		BR9EIX	3981
MC 490	490	-05.83	B9ES	2611	0,5	B9EVX	7254	202		BR9EIX	3981
500	500	94 -	B9ES	2611	0,5	B9EVX	7254	202		BR9EIX	3981







					Order No.		Gold-Palladium	Platin 	Order No.	Quick-No.	Iridium 	Order No.
MAICO												
GS 500	500		B9ES	2611	0,5	B9EVX	7254	202	BR9EIX	3981		
GS Star 500	500		B9ES	2611	0,5	B9EVX	7254	202	BR9EIX	3981		
GS Star E 500	500		B9ES	2611	0,5	B9EVX	7254	202	BR9EIX	3981		
MC 500	500		B9ES	2611	0,5	B9EVX	7254	202	BR9EIX	3981		
685 Gespann	685	94 -			0,6	B10EVX	7335					
MALAGUTI												
Custon Fox	50		B6HS	4510	0,5	B6HVX	7435	203	BR6HIX	3419		
Fifty Top	50		B9ES	2611	0,5	B9EVX	7254	202	BR9EIX	3981		
Grizzly RCW4/RCW50/RCX10	50		B6HS	4510	0,5	B6HVX	7435	203	BR6HIX	3419		
Grizzly RCX50,Ranocchio	50		B6HS	4510	0,5	B6HVX	7435	203	BR6HIX	3419		
RCX 4	50		B8HS	5510	0,5	B8HVX	2634	205	BR8HIX	7001		
RCX 10 Automatic	50		B6HS	4510	0,5	B6HVX	7435	203	BR6HIX	3419		
RCX 12 Automatic	50		B8HS	5510	0,5	B8HVX	2634	205	BR8HIX	7001		
Dune Enduro 75	75		B7ES	1111	0,5	B7EVX	6934					
RST 75 Turismo	75		B7ES	1111	0,5	B7EVX	6934					
Runner 125 Rally	125		B9ES	2611	0,5	B9EVX	7254	202	BR9EIX	3981		
Runner 125 YLC	125		B8ES	2411	0,5	B8EVX	7051	201	BR8EIX	5044		
MARS												
M 25	25		B5HS	4210	0,8							
Enduro Dakarino	50		B8HCS	2621	0,6							
M 25 Mini Califo	50		B5HS	4210	0,8							
M 50	50		B5HS	4210	0,8							
MK 50	50		BPR6HSA	4632	0,6	BPR6HVX	2740		BPR6HIX	4085		
MBK												
41	49		B6HS	4510	0,5	B6HVX	7435	203	BR6HIX	3419		
50 EV	49		B6HS	4510	0,5	B6HVX	7435	203	BR6HIX	3419		
50 EW	49		B6HS	4510	0,5	B6HVX	7435	203	BR6HIX	3419		
50 L	49		B6HS	4510	0,5	B6HVX	7435	203	BR6HIX	3419		
50 S	49		B6HS	4510	0,5	B6HVX	7435	203	BR6HIX	3419		
50 VL	49		B6HS	4510	0,5	B6HVX	7435	203	BR6HIX	3419		
50 VS	49		B6HS	4510	0,5	B6HVX	7435	203	BR6HIX	3419		
51 New West	49		B6HS	4510	0,5	B6HVX	7435	203	BR6HIX	3419		
51 S	49		B6HS	4510	0,5	B6HVX	7435	203	BR6HIX	3419		
51 SL	49		B6HS	4510	0,5	B6HVX	7435	203	BR6HIX	3419		
51 Super	49		B6HS	4510	0,5	B6HVX	7435	203	BR6HIX	3419		
51 Super Special	49		B6HS	4510	0,5	B6HVX	7435	203	BR6HIX	3419		
51 V	49		B6HS	4510	0,5	B6HVX	7435	203	BR6HIX	3419		
51 VL	49		B6HS	4510	0,5	B6HVX	7435	203	BR6HIX	3419		
88	49		B6HS	4510	0,5	B6HVX	7435	203	BR6HIX	3419		
88 IP	49		B6HS	4510	0,5	B6HVX	7435	203	BR6HIX	3419		
88 IU	49		B6HS	4510	0,5	B6HVX	7435	203	BR6HIX	3419		
89	49		B6HS	4510	0,5	B6HVX	7435	203	BR6HIX	3419		
Active	49		BPR7HS	6422	0,7	BPR7HVX	2938	215	BPR7HIX	5944		
AV 40	49		B6HS	4510	0,5	B6HVX	7435	203	BR6HIX	3419		
AV 42	49		B6HS	4510	0,5	B6HVX	7435	203	BR6HIX	3419		
AV 44	49		B6HS	4510	0,5	B6HVX	7435	203	BR6HIX	3419		
AV 46	49		B6HS	4510	0,5	B6HVX	7435	203	BR6HIX	3419		
AV 48	49		B6HS	4510	0,5	B6HVX	7435	203	BR6HIX	3419		
AV 56	49		B6HS	4510	0,5	B6HVX	7435	203	BR6HIX	3419		







					Order No.		Platin 	Order No.	Quick-No. 	Iridium	Order No.
MBK											
AV 59		49	B6HS	4510	0,5	B6HVX	7435	203	BR6HIX		3419
AV 65		49	B6HS	4510	0,5	B6HVX	7435	203	BR6HIX		3419
AV 68		49	B6HS	4510	0,5	B6HVX	7435	203	BR6HIX		3419
AV 76		49	B6HS	4510	0,5	B6HVX	7435	203	BR6HIX		3419
AV 79		49	B6HS	4510	0,5	B6HVX	7435	203	BR6HIX		3419
AV 85		49	B6HS	4510	0,5	B6HVX	7435	203	BR6HIX		3419
AV 88		49	B6HS	4510	0,5	B6HVX	7435	203	BR6HIX		3419
AV 89		49	B6HS	4510	0,5	B6HVX	7435	203	BR6HIX		3419
AV 92		49	B6HS	4510	0,5	B6HVX	7435	203	BR6HIX		3419
AV 98		49	B6HS	4510	0,5	B6HVX	7435	203	BR6HIX		3419
Cady		49	B6HS	4510	0,5	B6HVX	7435	203	BR6HIX		3419
CF		49	B6HS	4510	0,5	B6HVX	7435	203	BR6HIX		3419
Champ		49	B6HS	4510	0,5	B6HVX	7435	203	BR6HIX		3419
Daytona Beach		49	B6HS	4510	0,5	B6HVX	7435	203	BR6HIX		3419
Daytona Cruiser		49	B6HS	4510	0,5	B6HVX	7435	203	BR6HIX		3419
FXK		49	B8ES	2411	0,5	B8EVX	7051	201	BR8EIX		5044
G 40		49	B6HS	4510	0,5	B6HVX	7435	203	BR6HIX		3419
G 50		49	B6HS	4510	0,5	B6HVX	7435	203	BR6HIX		3419
Hobby IV		49	BP6ES	7811	0,5	BP6EVX	5832		BPR6EIX		6637
KW Magnum		49	B6HS	4510	0,5	B6HVX	7435	203	BR6HIX		3419
M 1		49	B6HS	4510	0,5	B6HVX	7435	203	BR6HIX		3419
M 1L		49	B6HS	4510	0,5	B6HVX	7435	203	BR6HIX		3419
M 1P		49	B6HS	4510	0,5	B6HVX	7435	203	BR6HIX		3419
M 1PR		49	B6HS	4510	0,5	B6HVX	7435	203	BR6HIX		3419
M 1PRT		49	B6HS	4510	0,5	B6HVX	7435	203	BR6HIX		3419
M 1PRTS		49	B6HS	4510	0,5	B6HVX	7435	203	BR6HIX		3419
Mobylett		49	B6HS	4510	0,5	B6HVX	7435	203	BR6HIX		3419
N 40		49	B6HS	4510	0,5	B6HVX	7435	203	BR6HIX		3419
N 50		49	B6HS	4510	0,5	B6HVX	7435	203	BR6HIX		3419
Rock		49	B6HS	4510	0,5	B6HVX	7435	203	BR6HIX		3419
SP 50		49	B6HS	4510	0,5	B6HVX	7435	203	BR6HIX		3419
SP 92		49	B6HS	4510	0,5	B6HVX	7435	203	BR6HIX		3419
SP 93		49	B6HS	4510	0,5	B6HVX	7435	203	BR6HIX		3419
SP 94		49	B6HS	4510	0,5	B6HVX	7435	203	BR6HIX		3419
SP 98		49	B6HS	4510	0,5	B6HVX	7435	203	BR6HIX		3419
SP 99		49	B6HS	4510	0,5	B6HVX	7435	203	BR6HIX		3419
Weekly		49	B7HS	5110	0,5	B7HVX	7836	204	BR7HIX		7067
X 1		49	B6HS	4510	0,5	B6HVX	7435	203	BR6HIX		3419
X 1L		49	B6HS	4510	0,5	B6HVX	7435	203	BR6HIX		3419
X 7L		49	B6HS	4510	0,5	B6HVX	7435	203	BR6HIX		3419
X 7S		49	B6HS	4510	0,5	B6HVX	7435	203	BR6HIX		3419
X 7VL		49	B6HS	4510	0,5	B6HVX	7435	203	BR6HIX		3419
X 7VS		49	B6HS	4510	0,5	B6HVX	7435	203	BR6HIX		3419
ZX		49	BR7HS	4122	0,5			211	BR7HIX		7067
151 L		50	01.79 -07.83	B6HS	4510	0,5	B6HVX	7435	203	BR6HIX	3419
151 LB		50	01.79 -07.83	B6HS	4510	0,5	B6HVX	7435	203	BR6HIX	3419
151 LC		50	01.79 -07.83	B6HS	4510	0,5	B6HVX	7435	203	BR6HIX	3419
50 R		50		B7HS	5110	0,5	B7HVX	7836	204	BR7HIX	7067
50 VL		50	01.71 -12.80	B6HS	4510	0,5	B6HVX	7435	203	BR6HIX	3419
50 VLC		50	01.71 -12.80	B6HS	4510	0,5	B6HVX	7435	203	BR6HIX	3419
51 SU		50	01.81 -07.83	B6HS	4510	0,5	B6HVX	7435	203	BR6HIX	3419
89		50	-07.83	B7HS	5110	0,5	B7HVX	7836	204	BR7HIX	7067



					Order No.		Platin 	Order No.	Quick-No.	Iridium 	Order No.
MBK											
93		50		B7HS	5110	0,5	B7HVX	7836	204	BR7HIX	7067
98		50	-07.83	B7HS	5110	0,5	B7HVX	7836	204	BR7HIX	7067
99		50		B7HS	5110	0,5	B7HVX	7836	204	BR7HIX	7067
D50		50		B7HS	5110	0,5	B7HVX	7836	204	BR7HIX	7067
Monty MB3V		50	01.77 -07.83	BP6ES	7811	0,5	BP6EVX	5832		BPR5EIX	6597
Monty SP3V		50	12.81 -	B6HS	4510	0,5	B6HVX	7435	203	BR6HIX	3419
Monty SP3V		50	-11.81	BP6ES	7811	0,6	BP6EVX	5832		BPR6EIX	6637
SP 94 TT		50		B7HS	5110	0,5	B7HVX	7836	204	BR7HIX	7067
X power		50	03 -	BR9ES	5722	0,8	BR9EVX	1265	208	BR9EIX	3981
D75		75		B8HS	5510	0,5	B8HVX	2634	205	BR8HIX	7001
125 12,7 mm		125		B8HS	5510	0,5	B8HVX	2634	205	BR8HIX	7001
125 19,0 mm		125		B8ES	2411	0,5	B8EVX	7051	201	BR8EIX	5044
250		250		B8ES	2411	0,5	B8EVX	7051	201	BR8EIX	5044
350		350	04.73 -04.79	B8ES	2411	0,5	B8EVX	7051	201	BR8EIX	5044
350 E		350		B8ES	2411	0,5	B8EVX	7051	201	BR8EIX	5044
350 Injection		350		B8ES	2411	0,5	B8EVX	7051	201	BR8EIX	5044
MECATECNO											
Chic,Funny,2,Cuc		50		B6HS	4510	0,5	B6HVX	7435	203	BR6HIX	3419
Dragon Fly School Boy		50		B6HS	4510	0,5	B6HVX	7435	203	BR6HIX	3419
Grac,Hobby,Huracan		50		B6HS	4510	0,5	B6HVX	7435	203	BR6HIX	3419
Micro GP,Mini 4		50		B6HS	4510	0,5	B6HVX	7435	203	BR6HIX	3419
Racing CR-7		50		B9ES	2611	0,5	B9EVX	7254	202	BR9EIX	3981
Tanga		50		BP6ES	7811	0,5	BP6EVX	5832		BPR6EIX	6637
Dragon Fly,Sky Walker		330		BP5ES	6511	0,5	BP5EVX	5470		BPR5EIX	6597
MR 326 Trial		330		BP5ES	6511	0,5	BP5EVX	5470		BPR5EIX	6597
MERLIN											
DG1,DG2/T		50		B5HS	4210	0,5					
DG7		125		BP5ES	6511	0,5	BP5EVX	5470		BPR5EIX	6597
DG3 350/Cresta/Trial/GR		350		BP5ES	6511	0,5	BP5EVX	5470		BPR5EIX	6597
DG3 350/FIUS		350		BP5ES	6511	0,5	BP5EVX	5470		BPR5EIX	6597
Nomada 500		500		D8EA	2120	0,5	D8EVX	2850	216	DR8EIX	6681
METEORIT / A . T . U											
Cruiser 125		125		DR8EA	7162	0,7	DR8EVX	6354		DR8EIX	6681
MIDWEST											
JC50Q-9		50	00 -	CR6HSA	2983	0,7				CR6HIX	7274
JC70Y		70	00 -	CR6HSA	2983	0,7				CR6HIX	7274
JS70Y		70	00 -	CR6HSA	2983	0,7				CR6HIX	7274
JS90Y		90	00 -	CR6HSA	2983	0,7				CR6HIX	7274
JC150Y		150	00 -	DR7EA	7839	0,7					
JS200Y		200	00 -	DR7EA	7839	0,7					
MINARELLI											
50 Cross		50				0,5	B10SEGV	2171			
50 Trial		50				0,5	B9SEGV	2145			
C2,E2,G1,V2,C3PK 12,7mm		50		B6HS	4510	0,5	B6HVX	7435	203	BR6HIX	3419
C2,E2,G1,V2,C3PK 19,0mm		50		B6ES	7310	0,5	B6EVX	5136			
C3KS		50		B6ES	7310	0,5	B6EVX	5136			
H3,P4E		50		B6HS	4510	0,5	B6HVX	7435	203	BR6HIX	3419

				Order No.		Platin 	Order No.	Quick-No.	Iridium 	Order No.			
MINARELLI													
P 6 Competizione	50				0,5	B95EGV	2145						
P 6 Super	50		B8HS	5510	0,5	B8HVX	2634	205	BR8HIX			7001	
P3N,P3A,P3S	50		B6HS	4510	0,5	B6HVX	7435	203	BR6HIX			3419	
P4, A, P6, E	50		B6HS	4510	0,5	B6HVX	7435	203	BR6HIX			3419	
P4CS, CSA, P4R	50		B7ES	1111	0,5	B7EVX	6934						
P6CS, CSA, P6R	50		B7ES	1111	0,5	B7EVX	6934						
RV4, A	50		B7ES	1111	0,5	B7EVX	6934						
V1,V1A,V1KS,VIP 12,7mm	50		B6HS	4510	0,5	B6HVX	7435	203	BR6HIX			3419	
V1,V1A,V1KS,VIP 19,0mm	50		B6ES	7310	0,5	B6EVX	5136						
V1H,V1HLE,V1L	50		B6HS	4510	0,5	B6HVX	7435	203	BR6HIX			3419	
W3 QM	60		B6HS	4510	0,5	B6HVX	7435	203	BR6HIX			3419	
Trial	75		B9EG	3530	0,5	B9EGV	5827		BR9EIX			3981	
MR 6/80	80				0,5	B11EGV	5831						
P 680	80		B6HS	4510	0,5	B6HVX	7435	203	BR6HIX			3419	
125 Cross	125				0,5	B95EGV	2145						
125 Regolarità	125				0,5	B95EGV	2145						
125 YPVS (Yamaha)	125		B8ES	2411	0,5	B8EVX	7051	201	BR8EIX			5044	
125/5	125		B8ES	2411	0,5	B8EVX	7051	201	BR8EIX			5044	
125/5 Cross	125				0,5	B10EGV	5927						
125/5 Regolarità	125				0,5	B10EGV	5927						
MINSK													
MMB3-3.112 7,3kW	125		BP7HS	5111	0,7	BP7HVX	7468		BPR7HIX			5944	
MMB3-3.113 7,3kW	125		BP7HS	5111	0,7	BP7HVX	7468		BPR7HIX			5944	
MMB3-3.1131 7,3kW	125		BP7HS	5111	0,7	BP7HVX	7468		BPR7HIX			5944	
MMB3-3.11311 7,3kW	125		BP7HS	5111	0,7	BP7HVX	7468		BPR7HIX			5944	
Mototeleschka C-3.901 7,3kW	125		BP7HS	5111	0,7	BP7HVX	7468		BPR7HIX			5944	
MONDIAL													
Cross Spezial	50		B7HS	5110	0,5	B7HVX	7836	204	BR7HIX			7067	
Mondialino	50		B7HS	5110	0,5	B7HVX	7836	204	BR7HIX			7067	
Radial	50		B8HS	5510	0,5	B8HVX	2634	205	BR8HIX			7001	
Regolarità	50		B8HS	5510	0,5	B8HVX	2634	205	BR8HIX			7001	
Spezial V4 Record	50		B7ES	1111	0,5	B7EVX	6934						
Touring	50		B8HS	5510	0,5	B8HVX	2634	205	BR8HIX			7001	
Tourismo	50		B7HS	5110	0,5	B7HVX	7836	204	BR7HIX			7067	
Cross Radial v6	125		B7HS	5110	0,5	B7HVX	7836	204	BR7HIX			7067	
175 SS	175		B9HS	5810	0,5	B9HVX	2254						
Piega VTR 1000 SP	1000	03 -							FR9B1-11			4709	
MONTESA													
Brio,Cirlo,Fura,Mini Cota	50		B7HS	5110	0,5	B7HVX	7836	204	BR7HIX			7067	
Cota 25A/25C/49,Mini Mont.	50		B7HS	5110	0,5	B7HVX	7836	204	BR7HIX			7067	
Scorpion 50R	50		B7HS	5110	0,5	B7HVX	7836	204	BR7HIX			7067	
Cota 74 /74T /80	75		B7ES	1111	0,5	B7EVX	6934						
Crono 75	75		B7ES	1111	0,5	B7EVX	6934						
Enduro 75 H6 /H7/ L	75		B7ES	1111	0,5	B7EVX	6934						
Cota 123/C/T, Cota 125	123		B8ES	2411	0,5	B8EVX	7051	201	BR8EIX			5044	
MH 123	123		BPR7ES	2023	0,6	BPR7EVX	5565		BPR7EIX			4055	
Cappra 125 MX	125		B8HS	5510	0,5	B8HVX	2634	205	BR8HIX			7001	
Cappra 125 VA/VB/VE/VF	125		B10ES	7928	0,5	B10EVX	7335		BR10EIX			6801	
Crono 125D	125		B8ES	2411	0,5	B8EVX	7051	201	BR8EIX			5044	

					Order No.		Gold-Palladium	Platin 	Order No.	Quick-No.	Iridium 	Order No.
MONTESA												
Enduro 125 H6/H7/L	125		B8ES	2411	0,5	B8EVX	7051	201	BR8EIX		5044	
Cota 172/200	175		B7ES	1111	0,5	B7EVX	6934					
Impala /2/Sport	175		B7HS	5110	0,5	B7HVX	7836	204	BR7HIX		7067	
Impala 175 Comando/Turismo	175		B6HS	4510	0,5	B6HVX	7435	203	BR6HIX		3419	
Kenya 175, Texas 175	175		B6HS	4510	0,5	B6HVX	7435	203	BR6HIX		3419	
MH 200	200		BPR7ES	2023	0,6	BPR7EVX	5565		BPR7EIX		4055	
Cappra MX	250		B8HS	5510	0,6	B8HVX	2634	205	BR8HIX		7001	
Cappra VA/B/E/F/G/R	250		B9ES	2611	0,5	B9EVX	7254	202	BR9EIX		3981	
Cappra 250 /GP/MX	250		B8HS	5510	0,5	B8HVX	2634	205	BR8HIX		7001	
Cappra 250 CA/VB/VE	250		B9ES	2611	0,5	B9EVX	7254	202	BR9EIX		3981	
Cappra 250 VF/VG/VR	250		B9ES	2611	0,5	B9EVX	7254	202	BR9EIX		3981	
Cota 242 /304 /307	250		BP7ES	2412	0,5	BP7EVX	7270	206	BPR7EIX		4055	
Cota 247 /C/T	250		B8HS	5510	0,5	B8HVX	2634	205	BR8HIX		7001	
Cota 248	250		BP5ES	6511	0,5	BP5EVX	5470		BPR5EIX		6597	
Cota 4RT	250	05 -	CR6EH-9	2688	0,6							
Enduro 250 H6	250		B8ES	2411	0,5	B8EVX	7051	201	BR8EIX		5044	
Enduro 250 H7	250		B10EG	3630	0,5	B10EGV	5927					
Impala	250		B8HS	5510	0,6	B8HVX	2634	205	BR8HIX		7001	
Impala 250 King	250		B8HS	5510	0,5	B8HVX	2634	205	BR8HIX		7001	
Impala 250 Scorpion/Sport	250		B8HS	5510	0,5	B8HVX	2634	205	BR8HIX		7001	
K.Scorpion	250		B8HS	5510	0,6	B8HVX	2634	205	BR8HIX		7001	
Enduro Rapita 250 Automix	250		B8ES	2411	0,5	B8EVX	7051	201	BR8EIX		5044	
Cota 309	260		BPR7ES	2023	0,6	BPR7EVX	5565		BPR7EIX		4055	
Cota 310/Evasion	260		BPR7ES	2023	0,6	BPR7EVX	5565		BPR7EIX		4055	
Cota 311	260		BPR5ES	7422	0,6	BPR5EVX	4875		BPR5EIX		6597	
Cota 348,Trial	310		BP5ES	6511	0,5	BP5EVX	5470		BPR5EIX		6597	
315R	315	97 -	BR6ES	4922	0,8							
Cota 330,Trial	330		BP5ES	6511	0,5	BP5EVX	5470		BPR5EIX		6597	
MH 349	349		BPR5ES	7422	0,6	BPR5EVX	4875		BPR5EIX		6597	
Cota 335/335E/349/349T/350	350		BP5ES	6511	0,5	BP5EVX	5470		BPR5EIX		6597	
Crono 350	350		B7ES	1111	0,5	B7EVX	6934					
Enduro 360 H6/H7/H7S/L	350		B7ES	1111	0,5	B7EVX	6934					
Cappra GP,Cappra 360VA/VB	360		B8ES	2411	0,5	B8EVX	7051	201	BR8EIX		5044	
Cappra 414VE/VF/VG	410		B8ES	2411	0,5	B8EVX	7051	201	BR8EIX		5044	
MOTO GEROSA												
Cross Corsa Minarelli	50		B10ES	7928	0,5	B10EVX	7335		BR10EIX		6801	
Mini Pieghevole	50		B6HS	4510	0,6	B6HVX	7435	203	BR6HIX		3419	
Monotrave L 4M	50		B6ES	7310	0,7	B6EVX	5136					
Motocarro	50		B6HS	4510	0,6	B6HVX	7435	203	BR6HIX		3419	
Pulce Bimbo	50		B6HS	4510	0,6	B6HVX	7435	203	BR6HIX		3419	
Pulce Junior 4M	50		B6ES	7310	0,7	B6EVX	5136					
Regolarita Corsa Zündapp / 6M	50		B8ES	2411	0,5	B8EVX	7051	201	BR8EIX		5044	
V1 Export	50		B6HS	4510	0,6	B6HVX	7435	203	BR6HIX		3419	
V1 Monotrave	50		B6HS	4510	0,6	B6HVX	7435	203	BR6HIX		3419	
V110	50		B6HS	4510	0,6	B6HVX	7435	203	BR6HIX		3419	
MOTO GUZZI												
Cross 50	50		B5HS	4210	0,5							
Dingo 3M	50		B6HS	4510	0,5	B6HVX	7435	203	BR6HIX		3419	
Dingo MM	50		B6HS	4510	0,5	B6HVX	7435	203	BR6HIX		3419	
Furghino	50		B6HS	4510	0,5	B6HVX	7435	203	BR6HIX		3419	

					Order No.		Platin 	Order No.	Quick-No.	Iridium 	Order No.
MOTO GUZZI											
Magnum	50		B6ES	7310	0,5		B6EVX	5136			
Nibbio	50		B7ES	1111	0,5		B7EVX	6934			
Trotter	50	10.70-12.73	B6HS	4510	0,5		B6HVX	7435	203	BR6HIX	3419
125 2C4T	125	10.79-12.83	C8HSA	6821	0,5		C8HVX	2672		CR8HIX	7669
125 TT	125	07.85-12.87	B9ES	2611	0,5		B9EVX	7254	202	BR9EIX	3981
125 Custom	125	01.86 -	B9ES	2611	0,5		B9EVX	7254	202	BR9EIX	3981
Turismo	125	01.74-12.79	B8ES	2411	0,5		B8EVX	7051	201	BR8EIX	5044
250 FD	250	74 - 76	D8EA	2120	0,5		D8EVX	2850	216	DR8EIX	6681
250 TS	250	01.74-07.80	B8ES	2411	0,5		B8EVX	7051	201	BR8EIX	5044
254	250	78 - 80	C8HSA	6821	0,5		C8HVX	2672		CR8HIX	7669
350 GTS	350	04.74-07.80	D8EA	2120	0,5		D8EVX	2850	216	DR8EIX	6681
350 NTX	350	10.86 -	BP8ES	2912	0,6		BP8EVX	2671			
V 35	350	06.77 -	BP7ES	2412	0,6		BP7EVX	7270	206	BPR7EIX	4055
V 35 Florida	350	05.86 -	BP8ES	2912	0,6		BP8EVX	2671			
V 35 II	350	12.80-01.87	B7ES	1111	0,5		B7EVX	6934			
V 35 III	350	07.85 -	BP8ES	2912	0,5		BP8EVX	2671			
V 35 Imola	350	11.79-01.87	B7ES	1111	0,5		B7EVX	6934			
V 35 Imola II	350	79 - 86	C8HSA	6821	0,5		C8HVX	2672		CR8HIX	7669
V 35 TT	350	06.84-12.87	BPR7ES	2023	0,5		BPR7EVX	5565		BPR7EIX	4055
V 350 Nevada	350	92 -	B8ES	2411	0,6		B8EVX	7051	201	BR8EIX	5044
400 GTS	400	05.75-07.80	DP8EA-9	5829	0,9		DPR8EVX-9	2202		DPR8EIX-9	2202
V 40 Imola	400		BP8ES	2912	0,6		BP8EVX	2671			
Monza 500	500	01.81-01.87	BP8ES	2912	0,6		BP8EVX	2671			
V 50	500	06.77 -	BP7ES	2412	0,6		BP7EVX	7270	206	BPR7EIX	4055
V 50 Custom	500	78 - 80	BP7ES	2412	0,6		BP7EVX	7270	206	BPR7EIX	4055
V 50 II	500	11.79-12.81	BP7ES	2412	0,5		BP7EVX	7270	206	BPR7EIX	4055
V 50 III	500	01.81-01.87	BP8ES	2912	0,5		BP8EVX	2671			
V 50 Monza II	500	06.84-12.87	C8HSA	6821	0,5		C8HVX	2672		CR8HIX	7669
V 65	650	87 -	BCPR6ES	2330	0,5						
V 65	650	- 86	BP8ES	2912	0,6		BP8EVX	2671			
V 65 Florida	650	92 -	B8ES	2411	0,6		B8EVX	7051	201	BR8EIX	5044
V 65 Florida	650	- 86	BP8ES	2912	0,6		BP8EVX	2671			
V 65 Lario	650	- 86	C8HSA	6821	0,5		C8HVX	2672		CR8HIX	7669
V 65 NTX	650	- 89	BP8ES	2912	0,6		BP8EVX	2671			
V 65 NTX	650	90 - 92	B8ES	2411	0,6		B8EVX	7051	201	BR8EIX	5044
V 65 Polizia NT	650		B8ES	2411	0,6		B8EVX	7051	201	BR8EIX	5044
V 65 SP	650	- 86	BP8ES	2912	0,6		BP8EVX	2671			
V 65 TT	650	- 86	BP8ES	2912	0,6		BP8EVX	2671			
V 7 Sport / Spezial	700		BP6ES	7811	0,5		BP6EVX	5832		BPR6EIX	6637
750 S	750	- 74	BP6ES	7811	0,5		BP6EVX	5832		BPR6EIX	6637
750 SP	750	92 -	B8ES	2411	0,6		B8EVX	7051	201	BR8EIX	5044
750 Targa	750	92 -	B8ES	2411	0,6		B8EVX	7051	201	BR8EIX	5044
Breva Touring	750	06 -	BR8ES	5422	0,6		BR8EVX	1262	207	BR8EIX	5044
Breva Naked	750	03 -	BR8ES	5422	0,6		BR8EVX	1262	207	BR8EIX	5044
Nevada Classic 750 ie	750	04 -	BR8ES	5422	0,6		BR8EVX	1262	207	BR8EIX	5044
V 75 Nevada	750	92 -	B8ES	2411	0,6		B8EVX	7051	201	BR8EIX	5044
V 75, Duna	750		C8HSA	6821	0,5		C8HVX	2672		CR8HIX	7669
V 750 NTX	750	92 -	B8ES	2411	0,6		B8EVX	7051	201	BR8EIX	5044
V 750 Polizia NT	750	92 -	B8ES	2411	0,6		B8EVX	7051	201	BR8EIX	5044
850 California	850	12.75-12.81	BP6ES	7811	0,6		BP6EVX	5832		BPR6EIX	6637
850 Le Mans II / III	850	01.78-12.81	BP6ES	7811	0,6		BP6EVX	5832		BPR6EIX	6637
850 T4	850	07.80-12.83	BP6ES	7811	0,6		BP6EVX	5832		BPR6EIX	6637

					Order No.		Gold-Palladium	Platin 	Order No.	Quick-No.	Iridium 	Order No.
MOTO GUZZI												
850 T5	850	06.83 - 12.87	BP6ES	7811	0,6	BP6EVX	5832				BPR6EIX	6637
850 TS 5	850	82 - 84	BP6ES	7811	0,6	BP6EVX	5832				BPR6EIX	6637
Breva 850 (Twin Spark) BPR6ES out, PMR8B in)	877	06 -	BPR6ES+ PMR8B	7822+ 6378	0,6							
Griso 850 (Twin Spark) BPR6ES out, PMR8B in)	877	06 -	BPR6ES+ PMR8B	7822+ 6378	0,6							
1000	1000		BP6ES	7811	0,6	BP6EVX	5832				BPR6EIX	6637
1000 GT	1000	88 -	BP6ES	7811	0,6	BP6EVX	5832				BPR6EIX	6637
1000 Le Mans	1000	90 -	BP7ES	2412	0,6	BP7EVX	7270	206			BPR7EIX	4055
1000 Le Mans IV	1000	01.85 - 89	BP8ES	2912	0,6	BP8EVX	2671					
1000 S	1000	89 -	BP7ES	2412	0,6	BP7EVX	7270	206			BPR7EIX	4055
1000 SP III	1000	88 - 92	BP6ES	7811	0,6	BP6EVX	5832				BPR6EIX	6637
California I.E.	1000	91 -	BP7ES	2412	0,6	BP7EVX	7270	206			BPR7EIX	4055
California III	1000	88 -	BP6ES	7811	0,6	BP6EVX	5832				BPR6EIX	6637
Daytona 1000	1000	92 -	D9EA	2420	0,6	D9EVX	2834				DR9EIX	4772
Quota 1000	1000	92 -	BP7ES	2412	0,6	BP7EVX	7270	206			BPR7EIX	4055
T 5 Polizia	1000	92 -	BP6ES	7811	0,6	BP6EVX	5832				BPR6EIX	6637
V 10 Centauro	1000	96 -	DR9EA	3437	0,7	DR9EVX	6361	219			DR9EIX	4772
Breva 1100 (Twin Spark) BPR6ES out, PMR8B in)	1100	06 -	BPR6ES+ PMR8B	7822+ 6378	0,6							
California 1100 KC	1100	94 -	BPR6ES	7822	0,6	BPR6EVX	6764				BPR6EIX	6637
California 1100 KD	1100	94 -	BPR6ES	7822	0,6	BPR6EVX	6764				BPR6EIX	6637
California Aluminium	1100	03 -	BPR6ES	7822	0,6	BPR6EVX	6764				BPR6EIX	6637
California EV (KD)	1100	97 -	BPR6ES	7822	0,6	BPR6EVX	6764				BPR6EIX	6637
California Jackal (KD)	1100	99 -	BPR6ES	7822	0,6	BPR6EVX	6764				BPR6EIX	6637
California Special	1100	02 -	BPR6ES	7822	0,6	BPR6EVX	6764				BPR6EIX	6637
California Special Sport (KD) 54kW	1100	02 -	BPR6ES	7822	0,6	BPR6EVX	6764				BPR6EIX	6637
California Stone (KD) 54kW	1100		BPR6ES	7822	0,6	BPR6EVX	6764				BPR6EIX	6637
California Titanium	1100	03 -	BPR6ES	7822	0,6	BPR6EVX	6764				BPR6EIX	6637
Daytona RS (KL)	1100	96 -	DR8EA	7162	0,7	DR8EVX	6354				DR8EIX	6681
Griso 1100 (Twin Spark) BPR6ES out, PMR8B in)	1100	05 -	BPR6ES+ PMR8B	7822+ 6378	0,6							
Quota 1100 (KM)	1100	06.98 -	BPR6ES	7822	0,6	BPR6EVX	6764				BPR6EIX	6637
Sport 1100i	1100	96 -	BPR6ES	7822	0,6	BPR6EVX	6764				BPR6EIX	6637
1100 Sport (KF) (Injec.)(Iniezione)	1100	96 -	BPR6ES	7822	0,6	BPR6EVX	6764				BPR6EIX	6637
Sport	1100	95 -	BPR6ES	7822	0,6	BPR6EVX	6764				BPR6EIX	6637
Stone Touring	1100	03 -	BPR6ES	7822	0,6	BPR6EVX	6764				BPR6EIX	6637
V 11 Scura	1100	03 -	BPR6ES	7822	0,6	BPR6EVX	6764				BPR6EIX	6637
V 11 Sport (KS)	1100	99 -	BPR6ES	7822	0,6	BPR6EVX	6764				BPR6EIX	6637
V 11 Le Mans (KS)	1100		BPR6ES	7822	0,6	BPR6EVX	6764				BPR6EIX	6637
V 11 Le Mans Nero Corsa (67kW)	1100	04 -	BPR6ES	7822	0,6	BPR6EVX	6764				BPR6EIX	6637
V 11 Rosso Mandello (KR)	1100	99 -	BPR6ES	7822	0,6	BPR6EVX	6764				BPR6EIX	6637
V 11 Naked	1100	03 -	BPR6ES	7822	0,6	BPR6EVX	6764				BPR6EIX	6637
GT TwinSpark BPR6ES out, PMR8B in)	1200	06 -	BPR6ES+ PMR8B	7822+ 6378	0,6							
Norge 1200 (Twin Spark) BPR6ES out, PMR8B in)	1200	06 -	BPR6ES+ PMR8B	7822+ 6378	0,6							
MGS 01	1250	04 -									DCPR9EIX	2316
MOTO KOSMOS												
RV100	100		B9ES	2611	0,5	B9EVX	7254	202			BR9EIX	3981
CV125	125		B8ES	2411	0,5	B8EVX	7051	201			BR8EIX	5044

						Order No.		Gold-Palladium		Order No.	Quick-No.	Iridium		Order No.
MOTO KOSMOS														
CVA125	125		B9ES	2611	0,5	B9EVX	7254	202	BR9EIX	3981				
KSR125	125		B9ES	2611	0,5	B9EVX	7254	202	BR9EIX	3981				
RV125	125		B8ES	2411	0,5	B8EVX	7051	201	BR8EIX	5044				
CV250	250		B8ES	2411	0,5	B8EVX	7051	201	BR8EIX	5044				
KSR250	250		B9ES	2611	0,5	B9EVX	7254	202	BR9EIX	3981				
RV250	250		B8ES	2411	0,5	B8EVX	7051	201	BR8EIX	5044				
RV350	350		B8ES	2411	0,5	B8EVX	7051	201	BR8EIX	5044				
CV500	500		B8ES	2411	0,5	B8EVX	7051	201	BR8EIX	5044				
MOTO MORINI														
350 Excalibur	350	92 -	BP7ES	2412	0,5	BP7EVX	7270	206	BPR7EIX	4055				
400 Dart	400	91 -	BP8ES	2912	0,5	BP8EVX	2671							
501 Excalibur	500	91 -	BP8ES	2912	0,5	BP8EVX	2671							
501 Excalibur	501	92 -	BP7ES	2412	0,5	BP7EVX	7270	206	BPR7EIX	4055				
MOTOR HISPANIA														
Cangurito Cross, MH	50		B6HS	4510	0,5	B6HVX	7435	203	BR6HIX	3419				
Cross/MH/MH49, Sport 49	50		B6HS	4510	0,5	B6HVX	7435	203	BR6HIX	3419				
Feria, Jabato, 50SL	50		B6ES	7310	0,5	B6EVX	5136							
Furia 4v	50		BR9ES	5722	0,8	BR9EVX	1265	208	BR9EIX	3981				
Furia 6v Cross / Super.	50		BR9ES	5722	0,8	BR9EVX	1265	208	BR9EIX	3981				
GT 81, MH 80	50		B6HS	4510	0,5	B6HVX	7435	203	BR6HIX	3419				
M 80 Automatico	50		B6ES	7310	0,5	B6EVX	5136							
Minicross	50		B7HS	5110	0,5	B7HVX	7836	204	BR7HIX	7067				
Racing RX	50		BR9ES	5722	0,8	BR9EVX	1265	208	BR9EIX	3981				
Style	50		B7HS	5110	0,5	B7HVX	7836	204	BR7HIX	7067				
MOTOR TEK														
MT 50	50	05 -	BR8HSA	5539	0,5	BR8HVX	6265		BR8HIX	7001				
MOTO-SPEZIAL														
Bassa-Lunga	1100	99 -	BP6ES	7811	0,8	BP6EVX	5832		BPR6EIX	6637				
Sportiva 1100i	1100	99 -	BP6ES	7811	0,8	BP6EVX	5832		BPR6EIX	6637				
MOTOTECHNIKA														
Motovelesiped	45	89 -	BP6HS	4511	0,7	BP6HVX	4635		BPR6HIX	4085				
Karpati	50		BP6HS	4511	0,6	BP6HVX	4635		BPR6HIX	4085				
Mokick	50		BP7HS	5111	0,7	BP7HVX	7468		BPR7HIX	5944				
Riga	50		BP6HS	4511	0,6	BP6HVX	4635		BPR6HIX	4085				
Tricycle "ZID-50"	50	98 -	BP7HS	5111	0,6	BP7HVX	7468		BPR7HIX	5944				
Turist	50		BP6HS	4511	0,6	BP6HVX	4635		BPR6HIX	4085				
Veachowina	50		BP6HS	4511	0,6	BP6HVX	4635		BPR6HIX	4085				
Veterok	50		BP6HS	4511	0,6	BP6HVX	4635		BPR6HIX	4085				
MTV														
50 Cross/ Sport	50		BP5ES	6511	0,5	BP5EVX	5470		BPR5EIX	6597				
MÜNCH														
Mammut 1000 TTS	1000	-12.82	BP8ES	2912	0,5	BP8EVX	2671							
4-1200 TS/TTS-E	1200	-12.82	BP8ES	2912	0,5	BP8EVX	2671							
Mammut 1200 TS	1200	-12.82	BP8ES	2912	0,5	BP8EVX	2671							



Order No.



Gold-Palladium



Order No.

Quick-No.

Iridium









Order No.







MV AGUSTA







350 B GT/S/Scrambler	350		B8ES	2411	0,5	B8EVX	7051	201	BR8EIX	5044
350 BE GT(216)	350		B8ES	2411	0,5	B8EVX	7051	201	BR8EIX	5044
350 BE GT/S/Scrambler	350		B8ES	2411	0,5	B8EVX	7051	201	BR8EIX	5044
350 BES (216)	350		B8ES	2411	0,5	B8EVX	7051	201	BR8EIX	5044
350 Sport	350	-12.80	B8ES	2411	0,5	B8EVX	7051	201	BR8EIX	5044
GT Electronique	350		B8ES	2411	0,5	B8EVX	7051	201	BR8EIX	5044
S Electronique	350		B8ES	2411	0,5	B8EVX	7051	201	BR8EIX	5044
Scrambler Electronique	350		B8ES	2411	0,5	B8EVX	7051	201	BR8EIX	5044
199,4C6	600		B8ES	2411	0,5	B8EVX	7051	201	BR8EIX	5044
4C75S/GT, 750GT/S/SS	750		B8ES	2411	0,5	B8EVX	7051	201	BR8EIX	5044
750 S American	750		B7ES	1111	0,5	B7EVX	6934			
F4 Brutale (oro) 93kW	750	99 -	CR9EKB	2305	0,7				CR9EIX	3521
F4 Senna 103KW	750	99 -	CR9EKB	2305	0,7				CR9EIX	3521
F4 Oro —> Fgst.300	750	99 -	CR9EKB	2305	0,7				CR9EIX	3521
F4 S SPR 103KW	750	99 -	CR9EKB	2305	0,7				CR9EIX	3521
F4 Brutale S	750	02 -	CR9EKB	2305	0,7				CR9EIX	3521
800 S	800	-06.80	B8ES	2411	0,5	B8EVX	7051	201	BR8EIX	5044
900 S	900	-06.80	B8ES	2411	0,5	B8EVX	7051	201	BR8EIX	5044
F4 Brutale 910	910	05 -	CR9EB	6955	0,7				CR9EIX	3521
F4 Brutale 910 R	910	06 -	CR9EB	6955	0,7				CR9EIX	3521
F 4 1000 Senna	1000	06 -	R0045J-10	7400						
F4 1000 Tamburini	1000	04 -	R0045J-10	7400						
F4 1000 S	1000	04 -	R0045J-10	7400						







MZ







125 Fun X	125	01 -	CR8E	1275	0,7	CR8EVX	6487	226	CR8EIX	4218
125 Fun X	125	03 -	CR8E	1275	0,6	CR8EVX	6487	226	CR8EIX	4218
125 SM	125	01 -	CR8E	1275	0,7	CR8EVX	6487	226	CR8EIX	4218
125 SX	125	01 -	CR8E	1275	0,7	CR8EVX	6487	226	CR8EIX	4218
125 Younster Cup	125	03 -	CR8E	1275	0,6	CR8EVX	6487	226	CR8EIX	4218
RT 125	125	00 -	CR8E	1275	0,6	CR8EVX	6487	226	CR8EIX	4218
RT 125 Classic	125	03 -	CR8E	1275	0,6	CR8EVX	6487	226	CR8EIX	4218
RT 125 SM	125	00 -	CR8E	1275	0,6	CR8EVX	6487	226	CR8EIX	4218
Saxon Roadstar 7kW	125		B8HS	5510	0,6	B8HVX	2634	205	BR8HIX	7001
Saxon Sportstar 7/11kW	125		B8HS	5510	0,6	B8HVX	2634	205	BR8HIX	7001
Saxon Roadstar 9kW	150		B8HS	5510	0,6	B8HVX	2634	205	BR8HIX	7001
Saxon Sportstar 9kW	150		B8HS	5510	0,6	B8HVX	2634	205	BR8HIX	7001
ETZ Classic 13/15kW	251		B8HS	5510	0,6	B8HVX	2634	205	BR8HIX	7001
Saxon 251 Fun 13/15kW	251		B8HS	5510	0,6	B8HVX	2634	205	BR8HIX	7001
Saxon 251 Tour 13/15kW	251		B8HS	5510	0,6	B8HVX	2634	205	BR8HIX	7001
ETZ 301 Classic 17kW	301		B8HS	5510	0,6	B8HVX	2634	205	BR8HIX	7001
Saxon 301 Fun 17kW	301		B8HS	5510	0,6	B8HVX	2634	205	BR8HIX	7001
Saxon 301 Tour 17kW	301		B8HS	5510	0,6	B8HVX	2634	205	BR8HIX	7001
Saxon 500 Country 25kW	500		D8EA	2120	0,7	D8EVX	2850	216	DR8EIX	6681
Saxon 500 Fun 20/25kW	500		D8EA	2120	0,7	D8EVX	2850	216	DR8EIX	6681
Saxon 500 Funkkrad 20/25kW	500		D8EA	2120	0,7	D8EVX	2850	216	DR8EIX	6681
Saxon 500 Tour 20/25kW	500		D8EA	2120	0,7	D8EVX	2850	216	DR8EIX	6681
Saxon 500 Voyager 20/25kW	500		D8EA	2120	0,7	D8EVX	2850	216	DR8EIX	6681
Silver Star Classic 500 20kW	500		D8EA	2120	0,7	D8EVX	2850	216	DR8EIX	6681
Silver Star Classic 500 25kW	500		D8EA	2120	0,7	D8EVX	2850	216	DR8EIX	6681
Silver Star Gespann 500 25kW	500	95 -	D8EA	2120	0,7	D8EVX	2850	216	DR8EIX	6681
Baghira	660	97 -	DPR9EA-9	5329	0,9	DPR9EVX-9	3854	222	DPR9EIX-9	5545

					Order No.		Gold-Palladium	Platin 	Order No.	Quick-No.	Iridium 	Order No.
MZ												
Baghira Black Panther (4NN)	660	99 -	DPR9EA-9	5329	0,9	DPR9EVX-9	3854	222	DPR9EIX-9	5545		
Baghira Black Panther HR	660	00 -	DPR9EA-9	5329	0,9	DPR9EVX-9	3854	222	DPR9EIX-9	5545		
Baghira Forest	660	99 -	DPR9EA-9	5329	0,9	DPR9EVX-9	3854	222	DPR9EIX-9	5545		
Baghira HR	660	99 -	DPR9EA-9	5329	0,9	DPR9EVX-9	3854	222	DPR9EIX-9	5545		
Baghira Street Moto (4NN)	660	99 -	DPR9EA-9	5329	0,9	DPR9EVX-9	3854	222	DPR9EIX-9	5545		
Baghira Street Moto HR	660	00 -	DPR9EA-9	5329	0,9	DPR9EVX-9	3854	222	DPR9EIX-9	5545		
Mastiff	660	97 -	DPR9EA-9	5329	0,9	DPR9EVX-9	3854	222	DPR9EIX-9	5545		
Replica 660	660	02.95 -	DPR9EA-9	5329	0,9	DPR9EVX-9	3854	222	DPR9EIX-9	5545		
Skorpion Cup (4NN)	660	96 -	DPR9EA-9	5329	0,9	DPR9EVX-9	3854	222	DPR9EIX-9	5545		
Skorpion Replica	660	02.95 -	DPR9EA-9	5329	0,9	DPR9EVX-9	3854	222	DPR9EIX-9	5545		
Skorpion Sport	660	94 -	DPR9EA-9	5329	0,9	DPR9EVX-9	3854	222	DPR9EIX-9	5545		
Skorpion Tour	660	94 -	DPR9EA-9	5329	0,9	DPR9EVX-9	3854	222	DPR9EIX-9	5545		
Skorpion Traveller	660	96 -	DPR9EA-9	5329	0,9	DPR9EVX-9	3854	222	DPR9EIX-9	5545		
1000 S	1000	04 -	BCPR6ET	2197	0,8							
1000 SF	1000	05 -	BCPR6ET	2197	0,8							
1000 ST	1000	05 -	BCPR6ET	2197	0,8							
MZ (TR)												
ETZ Standard OR	125	01.91 -	B8HS	5510	0,6	B8HVX	2634	205	BR8HIX	7001		
ETZ Standard	125	01.91 -	B8HS	5510	0,6	B8HVX	2634	205	BR8HIX	7001		
Saxon Tour 251	125	01.91 -	B8HS	5510	0,6	B8HVX	2634	205	BR8HIX	7001		
TS 125	125	01.75 -12.85	B8HS	5510	0,6	B8HVX	2634	205	BR8HIX	7001		
ETZ 150	150	01.84 -12.90	B8HS	5510	0,6	B8HVX	2634	205	BR8HIX	7001		
TS 150	150	01.75 -12.85	B8HS	5510	0,6	B8HVX	2634	205	BR8HIX	7001		
TS 250	250	01.75 -12.85	B8HS	5510	0,6	B8HVX	2634	205	BR8HIX	7001		
NORTON												
Atlas			BP8ES	2912	0,6	BP8EVX	2671					
Commander			C8E	7471	0,6	CR8EVX	6487		CR8EIX	4218		
Commando			BP7ES	2412	0,6	BP7EVX	7270	206	BPR7EIX	4055		
F 1			C8E	7471	0,6	CR8EVX	6487		CR8EIX	4218		
C 652 SM engine F650	650	99 -	D8EA	2120	0,6	D8EVX	2850	216	DR8EIX	6681		
NSU												
Konsul 1			B7HS	5110	0,5	B7HVX	7836	204	BR7HIX	7067		
Konsul 2			B7HS	5110	0,5	B7HVX	7836	204	BR7HIX	7067		
Quick 50 4,3PS	50	04.62 -	B6HS	4510	0,5	B6HVX	7435	203	BR6HIX	3419		
Quickly TT 1,2+1,7PS	50	-12.61	B6HS	4510	0,5	B6HVX	7435	203	BR6HIX	3419		
Quickly T 1,2+1,7PS	50	-12.64	B6HS	4510	0,5	B6HVX	7435	203	BR6HIX	3419		
Quickly S / 2 1,2+1,7PS	50	01.62 -	B6HS	4510	0,5	B6HVX	7435	203	BR6HIX	3419		
Quickly S 23 1,2+1,7PS	50	01.62 -	B6HS	4510	0,5	B6HVX	7435	203	BR6HIX	3419		
Quickly TTK 1,2+1,7PS	50	01.62 -	B6HS	4510	0,5	B6HVX	7435	203	BR6HIX	3419		
Quickly N / N23 1,2+1,7PS	50	01.63 -	B6HS	4510	0,5	B6HVX	7435	203	BR6HIX	3419		
Quickly F23 1,2+1,7PS	50	01.63 -	B6HS	4510	0,5	B6HVX	7435	203	BR6HIX	3419		
Quickly S 2 1,2+1,7PS	50	-12.63	B6HS	4510	0,5	B6HVX	7435	203	BR6HIX	3419		
125 ZDB	125		B7HS	5110	0,5	B7HVX	7836	204	BR7HIX	7067		
Fox 4Takt	125		B7HS	5110	0,5	B7HVX	7836	204	BR7HIX	7067		
Fox 2Takt	125		B8HS	5510	0,5	B8HVX	2634	205	BR8HIX	7001		
Super Fox	125		B8HS	5510	0,5	B8HVX	2634	205	BR8HIX	7001		
Prima 3 7,4PS	150	01.58 -12.61	B6HS	4510	0,5	B6HVX	7435	203	BR6HIX	3419		
Prima 3K 7,4PS	150	01.58 -12.61	B6HS	4510	0,5	B6HVX	7435	203	BR6HIX	3419		
Prima 3KL 7,4PS	150	01.58 -12.61	B6HS	4510	0,5	B6HVX	7435	203	BR6HIX	3419		

						Order No.		Platin 	Order No.	Quick-No.	Iridium 	Order No.
NSU												
Maxi 12,5PS	175	01.57 -12.61	B6HS	4510	0,5	B6HVX	7435	203	BR6HIX		3419	
Prima 5 9,5PS	175	01.57 -12.61	B6HS	4510	0,5	B6HVX	7435	203	BR6HIX		3419	
Lux	200		B7HS	5110	0,5	B7HVX	7836	204	BR7HIX		7067	
Super Lux	200		B8HS	5510	0,5	B8HVX	2634	205	BR8HIX		7001	
Max 17PS	250	01.55 -12.58	B8HS	5510	0,5	B8HVX	2634	205	BR8HIX		7001	
Super Max 18PS	250	01.59 -12.61	B6HS	4510	0,5	B6HVX	7435	203	BR6HIX		3419	
Supermax	250	56 -	B8HS	5510	0,5	B8HVX	2634	205	BR8HIX		7001	
Konsul Sport	500		B8HS	5510	0,5	B8HVX	2634	205	BR8HIX		7001	
OMER												
Cross Mini	50		B6HS	4510	0,6	B6HVX	7435	203	BR6HIX		3419	
Daytona 8 Mini	50		B6HS	4510	0,6	B6HVX	7435	203	BR6HIX		3419	
Maggiolino	50		B5HS	4210	0,5							
Maggiolione	50		B5HS	4210	0,5							
Tanga / Noleggiato	50		B6HS	4510	0,6	B6HVX	7435	203	BR6HIX		3419	
Vallelunga 10	50		B6HS	4510	0,6	B6HVX	7435	203	BR6HIX		3419	
Vivo	50		BP6ES	7811	0,6	BP6EVX	5832		BPR6EIX		6637	
OSSA												
Ossita 50	50		B5HS	4210	0,5							
125 Enduro/Super Pioneer	125		B8ES	2411	0,5	B8EVX	7051	201	BR8EIX		5044	
125 Moto Cross/Phantom	125		B9ES	2611	0,5	B9EVX	7254	202	BR9EIX		3981	
150 Phantom	150		B8ES	2411	0,5	B8EVX	7051	201	BR8EIX		5044	
160 GT-T2	160		B7ES	1111	0,5	B7EVX	6934					
175 American/Enduro/Sport	175		B8ES	2411	0,5	B8EVX	7051	201	BR8EIX		5044	
175 Moto Cross/Phantom	175		B9ES	2611	0,5	B9EVX	7254	202	BR9EIX		3981	
175 Super Pioneer/ 6 Dias	175		B8ES	2411	0,5	B8EVX	7051	201	BR8EIX		5044	
230 Explorer/Trial	230		BP5ES	6511	0,5	BP5EVX	5470		BPR5EIX		6597	
230 Super Pioneer	230		B8ES	2411	0,5	B8EVX	7051	201	BR8EIX		5044	
250 American Enduro/Copa	250		B9ES	2611	0,5	B9EVX	7254	202	BR9EIX		3981	
Copa F3	250				0,5	B9EVX	7254		BR9EIX		3981	
Desert, Phantom, S.Pioneer	250		B9ES	2611	0,5	B9EVX	7254	202	BR9EIX		3981	
Desert/Enduro/Moto Cross	250		B9ES	2611	0,5	B9EVX	7254	202	BR9EIX		3981	
M.A.R. Explorer / Trial	250		BP5ES	6511	0,5	BP5EVX	5470		BPR5EIX		6597	
Sport/Super Pioneer,TE 250	250		B9ES	2611	0,5	B9EVX	7254	202	BR9EIX		3981	
T, Copa,F3	250		B9ES	2611	0,5	B9EVX	7254	202	BR9EIX		3981	
TR 80,250 Exp./Trial/Tu-yo	250		BP5ES	6511	0,5	BP5EVX	5470		BPR5EIX		6597	
Urbe Phanton,Trofeo 250 E7	250		B9ES	2611	0,5	B9EVX	7254	202	BR9EIX		3981	
303 Trial,TR 80,	350		BP5ES	6511	0,5	BP5EVX	5470		BPR5EIX		6597	
350 Desert/Super Pionner	350		B8ES	2411	0,5	B8EVX	7051	201	BR8EIX		5044	
350 Explorer/Tu-yo , Trail	350		BP5ES	6511	0,5	BP5EVX	5470		BPR5EIX		6597	
500 S, Yankee	500		B8ES	2411	0,5	B8EVX	7051	201	BR8EIX		5044	
PEUGEOT												
101	50	04.75 -	B5HS	4210	0,5							
102	50	04.75 -	B5HS	4210	0,5							
103	50	04.75 -	B5HS	4210	0,5							
103 CRX	50		B8HS	5510	0,5	B8HVX	2634	205	BR8HIX		7001	
103 LC	50		B8ES	2411	0,5	B8EVX	7051	201	BR8EIX		5044	
103 LSM-D	50	06.82 -	B6HS	4510	0,5	B6HVX	7435	203	BR6HIX		3419	
103 MP/MR	50		B8HS	5510	0,5	B8HVX	2634	205	BR8HIX		7001	
103 Racen	50		B8HS	5510	0,5	B8HVX	2634	205	BR8HIX		7001	

						Order No.		Gold-Palladium		Order No.	Quick-No.	Iridium		Order No.
PUCH														
DS 50	50		B6HS	4510	0,5	B6HVX	7435	203	BR6HIX	3419				
DS 50 K	50		B6HS	4510	0,5	B6HVX	7435	203	BR6HIX	3419				
DS 50 KXN	50		B6HS	4510	0,5	B6HVX	7435	203	BR6HIX	3419				
DS 50 RN	50		B6HS	4510	0,5	B6HVX	7435	203	BR6HIX	3419				
DS 60 C	50		B6HS	4510	0,5	B6HVX	7435	203	BR6HIX	3419				
DS 60 CN	50		B6HS	4510	0,5	B6HVX	7435	203	BR6HIX	3419				
DS 60 R	50		B6HS	4510	0,5	B6HVX	7435	203	BR6HIX	3419				
DS 60 RN	50		B6HS	4510	0,5	B6HVX	7435	203	BR6HIX	3419				
GS 50	50		B9HCS	2721	0,5									
GT 50	50		B9HS	5810	0,5	B9HVX	2254							
GTL 50	50		B9HS	5810	0,5	B9HVX	2254							
M 50 Jet	50		B8HS	5510	0,5	B8HVX	2634	205	BR8HIX	7001				
M 50 Racing	50		B6HS	4510	0,5	B6HVX	7435	203	BR6HIX	3419				
M 50 SE	50		B6HS	4510	0,5	B6HVX	7435	203	BR6HIX	3419				
Maxi	50		B4H	4110	0,5									
Maxi 2 Gang	50		B5HS	4210	0,5									
Maxi II	50		B5HS	4210	0,5									
Maxi II-25	50		B4H	4110	0,5									
Maxi N	50		B5HS	4210	0,5									
Maxi S	50		B4H	4110	0,5									
MC 60 Scrambler	50		B8HS	5510	0,5	B8HVX	2634	205	BR8HIX	7001				
MS 25	50		B6HS	4510	0,5	B6HVX	7435	203	BR6HIX	3419				
MS 50 De Luxe Sears	50		B6HS	4510	0,5	B6HVX	7435	203	BR6HIX	3419				
MS 50 Standard Sears	50		B6HS	4510	0,5	B6HVX	7435	203	BR6HIX	3419				
MS 50 STD.California	50		B6HS	4510	0,5	B6HVX	7435	203	BR6HIX	3419				
MS 50 V	50		B6HS	4510	0,5	B6HVX	7435	203	BR6HIX	3419				
MS 50 V-Autolec	50		B6HS	4510	0,5	B6HVX	7435	203	BR6HIX	3419				
P 1 L	50		B4H	4110	0,5									
P 1 XL	50		B4H	4110	0,5									
R 50	50		B6HS	4510	0,5	B6HVX	7435	203	BR6HIX	3419				
R 50 K	50		B6HS	4510	0,5	B6HVX	7435	203	BR6HIX	3419				
R 50 M	50		B8HS	5510	0,5	B8HVX	2634	205	BR8HIX	7001				
R 50 V	50		B6HS	4510	0,5	B6HVX	7435	203	BR6HIX	3419				
R 60 R	50		B6HS	4510	0,5	B6HVX	7435	203	BR6HIX	3419				
VS 50 D	50		B6HS	4510	0,5	B6HVX	7435	203	BR6HIX	3419				
VS 50 DK	50		B6HS	4510	0,5	B6HVX	7435	203	BR6HIX	3419				
VS 50 DS	50		B6HS	4510	0,5	B6HVX	7435	203	BR6HIX	3419				
VS 50 L	50		B6HS	4510	0,5	B6HVX	7435	203	BR6HIX	3419				
VS 50 L-Autolec	50		B6HS	4510	0,5	B6HVX	7435	203	BR6HIX	3419				
VS 60 R	50		B6HS	4510	0,5	B6HVX	7435	203	BR6HIX	3419				
VZ 50 K	50		B6HS	4510	0,5	B6HVX	7435	203	BR6HIX	3419				
VZ 50 M	50		B8HS	5510	0,5	B8HVX	2634	205	BR8HIX	7001				
VZ 50 R	50		B6HS	4510	0,5	B6HVX	7435	203	BR6HIX	3419				
VZ 50 V	50		B6HS	4510	0,5	B6HVX	7435	203	BR6HIX	3419				
VZ 60 R	50		B6HS	4510	0,5	B6HVX	7435	203	BR6HIX	3419				
X 30	50		B6HS	4510	0,5	B6HVX	7435	203	BR6HIX	3419				
X 50-3	50		B7HS	5110	0,5	B7HVX	7836	204	BR7HIX	7067				
Cobra 12,9 mm	80	81 -	B9HS	5810	0,5	B9HVX	2254							
Cobra 19,0 mm	80	81 -	B9ES	2611	0,5	B9EVX	7254	202	BR9EIX	3981				
MC 125	125		B9ES	2611	0,5	B9EVX	7254	202	BR9EIX	3981				
MC 175	175		B8ES	2411	0,5	B8EVX	7051	201	BR8EIX	5044				
GS 250	250		B8ES	2411	0,5	B8EVX	7051	201	BR8EIX	5044				

					Order No.		Gold-Palladium	Platin 	Order No.	Quick-No.	Iridium 	Order No.
PUCH												
MC 250		250		B9ES	2611	0,5	B9EVX	7254	202		BR9EIX	3981
GS 350		350		B10EG	3630	0,6	B10EGV	5927				
GS 366		366		B8ES	2411	0,5	B8EVX	7051	201		BR8EIX	5044
GS 500		500		DP9EA-9	6629	0,9	DP9EVX-9	3331			DPR9EIX-9	5545
MC 500		500				0,6	B10EGV	5927				
GS 560		560		DP9EA-9	6629	0,9	DP9EVX-9	3331			DPR9EIX-9	5545
REGENT												
Roadster,Tourer,RT 125		125		B7HS	5110	0,6	B7HVX	7836	204		BR7HIX	7067
Roadster,Tourer,RT 150		150		B7HS	5110	0,6	B7HVX	7836	204		BR7HIX	7067
Roadster,Tourer,RT 175		175		B7HS	5110	0,6	B7HVX	7836	204		BR7HIX	7067
REX												
Chopper 125		125		DR8EA	7162	0,7	DR8EVX	6354			DR8EIX	6681
Cruiser 125		125		DR8EA	7162	0,7	DR8EVX	6354			DR8EIX	6681
Fun Bike		125	00 -	DP7EA-9	5629	0,9	DPR7EVX-9	7682			DPR7EIX-9	7803
RIEJU												
Confort 402/403,Pony 50		50		B5HS	4210	0,5						
Confort 501,Helios,Varimat		50		B5HS	4210	0,5						
Drac 50(Air),Marathon 50		50		B6ES	7310	0,5	B6EVX	5136				
Drac(Water),RS-1,RV 50		50		B7ES	1111	0,5	B7EVX	6934				
MRX 50		50	03 -	BR8ES	5422	0,7	BR8EVX	1262	207		BR8EIX	5044
MX 50 (Child's)		50		B6HS	4510	0,5	B6HVX	7435	203		BR6HIX	3419
NKD 50 RS 2 Naked		50	03 -	BR8ES	5422	0,7	BR8EVX	1262	207		BR8EIX	5044
RR 50 AM6		50		BR8ES	5422	0,7	BR8EVX	1262	207		BR8EIX	5044
RR 50 Spezial Edition		50	03 -	BR8ES	5422	0,7	BR8EVX	1262	207		BR8EIX	5044
RS 2		50	03 -	BR8ES	5422	0,7	BR8EVX	1262	207		BR8EIX	5044
RS 1		50		BR8ES	5422	0,7	BR8EVX	1262	207		BR8EIX	5044
SMX 50		50	03 -	BR8ES	5422	0,7	BR8EVX	1262	207		BR8EIX	5044
Spike 50		50	03 -	BR8ES	5422	0,7	BR8EVX	1262	207		BR8EIX	5044
Sprint,Autom.Kick Starter		50		B5HS	4210	0,5						
Strada GT 49/GT Sport		50		B6ES	7310	0,5	B6EVX	5136				
Super Marathon 50/FDN/MT		50		B6ES	7310	0,5	B6EVX	5136				
Marathon 74 TT/Enduro		75		B6ES	7310	0,5	B6EVX	5136				
Marathon 75 Cross(Competi)		75				0,5	B10EGV	5927				
Marathon 75 Enduro		75				0,5	B10EGV	5927				
MR 74E,MR 75E,Strada GT75		75		B6ES	7310	0,5	B6EVX	5136				
TT 406		75		B6HS	4510	0,5	B6HVX	7435	203		BR6HIX	3419
MR 80 Enduro/Cross(Compet)		80				0,5	B10EGV	5927				
MR 80E, RST-80		80		B6ES	7310	0,5	B6EVX	5136				
MRX 125		125	03 -	BR8ES	5422	0,8	BR8EVX	1262	207		BR8EIX	5044
SMX 125		125	03 -	BR8ES	5422	0,8	BR8EVX	1262	207		BR8EIX	5044
RIERA												
Windy		50		BR7HS	4122	0,5				211	BR7HIX	7067
RIXE												
Champion FT / FTH		50		B6HS	4510	0,6	B6HVX	7435	203		BR6HIX	3419
Derby B		50		B7HS	5110	0,5	B7HVX	7836	204		BR7HIX	7067
Derby D		50		B8HS	5510	0,5	B8HVX	2634	205		BR8HIX	7001
Geschäftsmoped		50		B7HS	5110	0,5	B7HVX	7836	204		BR7HIX	7067

					Order No.		Platin 	Order No.	Quick-No.	Iridium 	Order No.
RIXE											
Hight Sport	50	B6HS	4510	0,6	B6HVX	7435	203	BR6HIX	3419		
Libelle E21	50	B4H	4110	0,5							
Libelle E23	50	B4H	4110	0,5							
Libelle FT/FTH/GTH	50	B6HS	4510	0,6	B6HVX	7435	203	BR6HIX	3419		
Libelle Hight Sport Super	50	B4H	4110	0,5							
R503	50	B6HS	4510	0,6	B6HVX	7435	203	BR6HIX	3419		
R504	50	B7HS	5110	0,5	B7HVX	7836	204	BR7HIX	7067		
RS50 B3/ B4	50	B6HS	4510	0,6	B6HVX	7435	203	BR6HIX	3419		
RS50S	50	B8HS	5510	0,5	B8HVX	2634	205	BR8HIX	7001		
Standard 7 h	50	B7HS	5110	0,5	B7HVX	7836	204	BR7HIX	7067		
Turismo 4	50	B7HS	5110	0,5	B7HVX	7836	204	BR7HIX	7067		
Turismo E21	50	B6HS	4510	0,6	B6HVX	7435	203	BR6HIX	3419		
Turismo ELS	50	B6HS	4510	0,6	B6HVX	7435	203	BR6HIX	3419		
Turismo SL40	50	B6HS	4510	0,6	B6HVX	7435	203	BR6HIX	3419		
RIZZATO											
Califfo K	50	B5HS	4210	0,5							
Califfo 121 matic	50	B6HS	4510	0,6	B6HVX	7435	203	BR6HIX	3419		
Califfo 80	50	B5HS	4210	0,5							
Califfo engine 119	50	B5HS	4210	0,5							
Califfo Mini	50	B5HS	4210	0,5							
Califfo Monomarcia Super	50	B6HS	4510	0,6	B6HVX	7435	203	BR6HIX	3419		
Califfone 4 M	50	B5HS	4210	0,5							
Cross Satan 71	50	B6HS	4510	0,6	B6HVX	7435	203	BR6HIX	3419		
Gio	50	B5HS	4210	0,5							
Mirage P4 Daytona	50	B6HS	4510	0,6	B6HVX	7435	203	BR6HIX	3419		
Piu	50	B5HS	4210	0,5							
Ringo	50	B6HS	4510	0,6	B6HVX	7435	203	BR6HIX	3419		
Satan	50	B6HS	4510	0,6	B6HVX	7435	203	BR6HIX	3419		
Super Luxe 73	50	B6HS	4510	0,6	B6HVX	7435	203	BR6HIX	3419		
Super Sprint Mirage	50	B6HS	4510	0,6	B6HVX	7435	203	BR6HIX	3419		
Turismo Monomarcia	50	B6HS	4510	0,6	B6HVX	7435	203	BR6HIX	3419		
Zum 3	50	B6HS	4510	0,6	B6HVX	7435	203	BR6HIX	3419		
Cross Coguaro	125	B8ES	2411	0,5	B8EVX	7051	201	BR8EIX	5044		
Tourismo	125	B8ES	2411	0,5	B8EVX	7051	201	BR8EIX	5044		
ROYAL ENFIELD											
Bonny	50	B6HS	4510	0,5	B6HVX	7435	203	BR6HIX	3419		
Sunny	50	B6HS	4510	0,5	B6HVX	7435	203	BR6HIX	3419		
KB 100	100	B8ES	2411	0,5	B8EVX	7051	201	BR8EIX	5044		
Bullet Strada 12,7 mm	350	BR6HS	3922	0,6				209	BR6HIX	3419	
Bullet Strada 19,0 mm	350	BR6ES	4922	0,6							
De Luxe,Super Star 12,7 mm	350	BR6HS	3922	0,6				209	BR6HIX	3419	
De Luxe,Super Star 19,0 mm	350	BR6ES	4922	0,6							
India	350	B7HS	5110	0,5	B7HVX	7836	204	BR7HIX	7067		
Bullet Sixty 5	500	BR8ES	5422	0,7	BR8EVX	1262	207	BR8EIX	5044		
Bullet 500 Standard	500	BR8ES	5422	0,7	BR8EVX	1262	207	BR8EIX	5044		
Bullet 500 de Luxe	500	BR8ES	5422	0,7	BR8EVX	1262	207	BR8EIX	5044		
Bullet Electra	500	B9ES	2611	0,5	B9EVX	7254	202	BR9EIX	3981		
India	500	B8ES	2411	0,5	B8EVX	7051	201	BR8EIX	5044		



Order No.



Gold-Palladium



Platin

Order No.

Quick-No.

Iridium



Order No.

S.I.S.

4 Cyclone	50		B8HS	5510	0,5	B8HVX	2634	205	BR8HIX	7001
Almirante 4/5	50		B8HS	5510	0,5	B8HVX	2634	205	BR8HIX	7001
Asa d'Ouro	50		B6HS	4510	0,6	B6HVX	7435	203	BR6HIX	3419
Brass	50		B6HS	4510	0,6	B6HVX	7435	203	BR6HIX	3419
EKO 70	50		B7HS	5110	0,5	B7HVX	7836	204	BR7HIX	7067
Felino	50		B7HS	5110	0,5	B7HVX	7836	204	BR7HIX	7067
Lebre / V4	50		B8HS	5510	0,5	B8HVX	2634	205	BR8HIX	7001
Mini Sport	50		B7HS	5110	0,5	B7HVX	7836	204	BR7HIX	7067
Mini Turismo	50		B7HS	5110	0,5	B7HVX	7836	204	BR7HIX	7067
Minor GT	50		B6HS	4510	0,6	B6HVX	7435	203	BR6HIX	3419
V5 Sport	50		B8HS	5510	0,5	B8HVX	2634	205	BR8HIX	7001
V5 Super Sport	50		B8HS	5510	0,5	B8HVX	2634	205	BR8HIX	7001
V5 Turismo	50		B8HS	5510	0,5	B8HVX	2634	205	BR8HIX	7001

SACHS

Saxonette Classic	30		BP4	2911	0,5					
Saxonette	30	01.87 -	BPR4S	4427	0,5					
City Bike C1	50	10.72 -08.78	B6HS	4510	0,7	B6HVX	7435	203	BR6HIX	3419
City Bike C2	50	10.72 -08.78	B6HS	4510	0,7	B6HVX	7435	203	BR6HIX	3419
City Bike C3	50	09.74 -08.78	B6HS	4510	0,7	B6HVX	7435	203	BR6HIX	3419
Dirty Devil 50	50		BP5HS	4111	0,5					
Enduro ZX 50	50		BR8ES	5422	0,5	BR8EVX	1262	207	BR8EIX	5044
Hobby Rider HR 1	50	10.72 -12.87	B6HS	4510	0,7	B6HVX	7435	203	BR6HIX	3419
Hobby Rider HR 2	50	10.72 -12.87	B6HS	4510	0,7	B6HVX	7435	203	BR6HIX	3419
Jogging	50		B6HS	4510	0,5	B6HVX	7435	203	BR6HIX	3419
K 50	50	-08.78	B8HS	5510	0,7	B8HVX	2634	205	BR8HIX	7001
K 50 Ultra	50	-08.78	B8HS	5510	0,7	B8HVX	2634	205	BR8HIX	7001
K 50 Ultra II	50	-08.78	B8HS	5510	0,5	B8HVX	2634	205	BR8HIX	7001
K 50 Ultra LC	50	-08.78	B9ES	2611	0,5	B9EVX	7254	202	BR9EIX	3981
K 50 Ultra LC II	50	-08.78	B9ES	2611	0,5	B9EVX	7254	202	BR9EIX	3981
K 50 Ultra LC III	50	-08.78	B9ES	2611	0,5	B9EVX	7254	202	BR9EIX	3981
KX 5	50	01.86 -	BP7HS	5111	0,5	BP7HVX	7468		BPR7HIX	5944
KX 50	50		B6HS	4510	0,5	B6HVX	7435	203	BR6HIX	3419
Lastboy	50		B7HS	5110	0,5	B7HVX	7836	204	BR7HIX	7067
M1	50	10.72 -12.77	B6HS	4510	0,5	B6HVX	7435	203	BR6HIX	3419
M2	50	10.72 -12.77	B6HS	4510	0,5	B6HVX	7435	203	BR6HIX	3419
M4	50	09.74 -12.78	B6HS	4510	0,5	B6HVX	7435	203	BR6HIX	3419
M5	50	09.74 -12.78	B6HS	4510	0,5	B6HVX	7435	203	BR6HIX	3419
MadAss 50	50		CR7HSA	4549	0,8				CR7HIX	7544
MK 1S	50	01.78 -08.80	B6HS	4510	0,5	B6HVX	7435	203	BR6HIX	3419
MK 2S	50	01.78 -08.80	B6HS	4510	0,5	B6HVX	7435	203	BR6HIX	3419
MP 2	50	10.72 -12.77	B6HS	4510	0,5	B6HVX	7435	203	BR6HIX	3419
MP 4	50	10.72 -12.77	B6HS	4510	0,5	B6HVX	7435	203	BR6HIX	3419
MX 1	50	01.89 -	B5HS	4210	0,5					
MX 1	50		B6HS	4510	0,5	B6HVX	7435	203	BR6HIX	3419
Optima 3	50	01.78 -	B6HS	4510	0,5	B6HVX	7435	203	BR6HIX	3419
Optima 50	50		BR8HS	4322	0,5	BR8HVX	6265	212	BR8HIX	7001
Prima 2	50		BR5HS	3722	0,5					
Prima 2S	50	01.89 -	B5HS	4210	0,5					
Prima 3	50		B6HS	4510	0,5	B6HVX	7435	203	BR6HIX	3419
Prima 3S	50	01.89 -	B5HS	4210	0,5					
Prima 4	50		B6HS	4510	0,5	B6HVX	7435	203	BR6HIX	3419



Order No.



Gold-Palladium



Platin

Order No.

Quick-No.









Iridium















Order No.

SACHS

Prima 4LN,5LN	50		B6HS	4510	0,5	B6HVX	7435	203	BR6HIX	3419
Prima 5	50		B6HS	4510	0,5	B6HVX	7435	203	BR6HIX	3419
Prima 5,5S	50	01.89 -	BR5HS	3722	0,5					
Prima 6	50		B6HS	4510	0,5	B6HVX	7435	203	BR6HIX	3419
Prima G3	50		B6HS	4510	0,5	B6HVX	7435	203	BR6HIX	3419
Prima GT	50	01.89 -	B5HS	4210	0,5					
Prima GT,GX	50		B6HS	4510	0,5	B6HVX	7435	203	BR6HIX	3419
Prima Presto	50		B6HS	4510	0,5	B6HVX	7435	203	BR6HIX	3419
Prima Pronto	50		B6HS	4510	0,5	B6HVX	7435	203	BR6HIX	3419
Prima S	50		B6HS	4510	0,5	B6HVX	7435	203	BR6HIX	3419
Prima SL	50		B6HS	4510	0,5	B6HVX	7435	203	BR6HIX	3419
Prima SX	50		B6HS	4510	0,5	B6HVX	7435	203	BR6HIX	3419
Sport Bike SB1	50	10.72 -08.74	B8HS	5510	0,5	B8HVX	2634	205	BR8HIX	7001
Sport Bike SB2	50	10.72 -08.79	B6HS	4510	0,5	B6HVX	7435	203	BR6HIX	3419
Sport Bike SB3	50	09.74 -08.79	B6HS	4510	0,5	B6HVX	7435	203	BR6HIX	3419
Sport Bike SB5	50	09.74 -08.76	B8HS	5510	0,5	B8HVX	2634	205	BR8HIX	7001
Supra 2D,3D	50	06.80 -	B6HS	4510	0,5	B6HVX	7435	203	BR6HIX	3419
Supra 4	50	06.78 -	B7HS	5110	0,5	B7HVX	7836	204	BR7HIX	7067
Supra 4GP	50	01.80 -	B6HS	4510	0,5	B6HVX	7435	203	BR6HIX	3419
Supra Enduro	50	03.80 -	B6HS	4510	0,5	B6HVX	7435	203	BR6HIX	3419
Ultra 50	50		B9ES	2611	0,5	B9EVX	7254	202	BR9EIX	3981
XE 5	50	01.86 -	BP7HS	5111	0,5	BP7HVX	7468		BPR7HIX	5944
ZX 1	50		B7ES	1111	0,5	B7EVX	6934			
RX 9	80		B8HS	5510	0,5	B8HVX	2634	205	BR8HIX	7001
Ultra 80 LC	80		B8HS	5510	0,5	B8HVX	2634	205	BR8HIX	7001
Ultra 80 AC	80	01.82 -	B7HS	5110	0,5	B7HVX	7836	204	BR7HIX	7067
XE 9	80	01.82 -	B8HS	5510	0,5	B8HVX	2634	205	BR8HIX	7001
K 100 X	100		B8HS	5510	0,5	B8HVX	2634	205	BR8HIX	7001
Dirty Devil 110	110		C7HSA	4629	0,6	C7HVX	4533		CR7HIX	7544
K 125 BW Military	125	09.74 -	B8HS	5510	0,5	B8HVX	2634	205	BR8HIX	7001
K 125 GS	125		B9ES	2611	0,5	B9EVX	7254	202	BR9EIX	3981
K 125 MC	125		B9ES	2611	0,5	B9EVX	7254	202	BR9EIX	3981
K 125 S	125	10.72 -08.79			0,5	B9EVX	7254		BR9EIX	3981
K 125 T	125	10.72 -08.79			0,5	B9EVX	7254		BR9EIX	3981
K 125 X	125		B8HS	5510	0,5	B8HVX	2634	205	BR8HIX	7001
Roadster 125 V2	125	98 -	CR6HSA	2983	0,8				CR6HIX	7274
RS 125	125	97 -	BR8ES	5422	0,7	BR8EVX	1262	207	BR8EIX	5044
X-Road 125	125		CR8E	1275	0,6			226	CR8EIX	4218
XTC 125 V2 11kW	125	98 -	BR9ES	5722	0,8	BR9EVX	1265	208	BR9EIX	3981
XTC-N 125 V2 7,8kW	125	98 -	BR8ES	5422	0,8	BR8EVX	1262	207	BR8EIX	5044
ZX 125 15PS	125	97 -	BR9ES	5722	0,6	BR9EVX	1265	208	BR9EIX	3981
ZX 125 11PS	125	97 -	BR8ES	5422	0,6	BR8EVX	1262	207	BR8EIX	5044
ZX 125	125	97 -	BR8ES	5422	0,7	BR8EVX	1262	207	BR8EIX	5044
ZZ 125 Typ A >10kW	125	01 -	BR9ES	5722	0,8	BR9EVX	1265	208	BR9EIX	3981
ZZ 125 Typ B	125	01 -	BR8ES	5422	0,8	BR8EVX	1262	207	BR8EIX	5044
175 GS	175		B9ES	2611	0,5	B9EVX	7254	202	BR9EIX	3981
250 GS	250		B9ES	2611	0,5	B9EVX	7254	202	BR9EIX	3981
W 2000	294		BR7ES	5122	0,5	BR7EVX	4556			
350 GS	350				0,5	B9EVX	7254		BR9EIX	3981
Roadster 650	650	99 -	CR9E	6263	0,8	CR9EVX	5943	227	CR9EIX	3521
Roadster 800	800	01 -	DPR8EA-9	4929	0,9	DPR8EVX-9	2872	221	DPR8EIX-9	2202

													
SAN YANG													
Bullet 50 (G5A,B)	50		BR8HSA	5539	0,6	BR8HVX	6265		BR8HIX				7001
DIO (F5A,B,E)	50		BR8HSA	5539	0,6	BR8HVX	6265		BR8HIX				7001
SANGLAS													
350	350		BP6ES	7811	0,5	BP6EVX	5832		BPR6EIX				6637
400 E	400		BP6ES	7811	0,5	BP6EVX	5832		BPR6EIX				6637
400 Y (Motor Yamaha)	400		BP7ES	2412	0,7	BP7EVX	7270	206	BPR7EIX				4055
500 S/ S2-V5	500		BP6ES	7811	0,5	BP6EVX	5832		BPR6EIX				6637
SCORPA													
Easy Trail	250	94 -	BP5ES	6511	0,7	BP5EVX	5470		BPR5EIX				6597
SY 2001 (engine YamahaTY250Z)	250	01 -			0,6	BCP6EVX	6323						
Easy Trail	280	94 -	BP5ES	6511	0,7	BP5EVX	5470		BPR5EIX				6597
SHERCO													
Trial Kid	50	02 -										BR9EIX	3981
City Corp 125	125	05 -	BP5ES	6511	0,7	BP5EVX	5470		BPR5EIX				6597
Trail 1,2	125	00 -	BP5ES	6511	0,5	BP5EVX	5470		BPR5EIX				6597
Scottish Six Days Winner	250	00 -	BP5ES	6511	0,5	BP5EVX	5470		BPR5EIX				6597
Trail 2,5	250	00 -	BP5ES	6511	0,5	BP5EVX	5470		BPR5EIX				6597
Trail 2,9	250	00 -	BP5ES	6511	0,5	BP5EVX	5470		BPR5EIX				6597
4.5 4T	450	05 -	CR8EK	3478	0,7				CR8EIX				4218
SHERCO- HRD													
Enduro	50	02 -	BR8ES	5422	0,5	BR8EVX	1262	207	BR8EIX				5044
Super Motard	50	02 -	BR8ES	5422	0,5	BR8EVX	1262	207	BR8EIX				5044
SIAMOTO													
Birdie 25 Mofa	25	99 -	BPR6HS	7022	0,6	BPR6HVX	2740	214	BPR6HIX				4085
Birdie 50 Mockick	50	99 -	BPR6HS	7022	0,6	BPR6HVX	2740	214	BPR6HIX				4085
SIMONINI IMEA													
Competizione Sachs	50		B10EGV	5927	0,5	B10EVX	7335						
Indian	50		B6HS	4510	0,6	B6HVX	7435						3419
Indian	50		B8HS	5510	0,5	B8HVX	2634	203	BR6HIX				7001
Masetti Racing	50		B10EGV	5927	0,5	B10EVX	7335						
Masetti Strada	50		B10EGV	5927	0,5	B10EVX	7335						
Mustang Rino Baby	50		B8HS	5510	0,5	B8HVX	2634	205	BR8HIX				7001
SF 150	50		B10EGV	5927	0,5	B10EVX	7335						
Speedy 2 Morini	50		B7HS	5110	0,5	B7HVX	7836	204	BR7HIX				7067
Mustang Regularita 125	125		B10EGV	5927	0,5	B10EVX	7335						
Diamond Sachs	250		B10EGV	5927	0,5	B10EVX	7335						
Hard Racer	250		B10EGV	5927	0,5	B10EVX	7335						
Mustang 250A	250		B10EGV	5927	0,5	B10EVX	7335						
Mustang 250H20	250		B10EGV	5927	0,5	B10EVX	7335						
Mustang Cross SA	250		B10EGV	5927	0,5	B10EVX	7335						
Mustang Cross SSH20	250		B10EGV	5927	0,5	B10EVX	7335						
Shadow 250	250		B10EGV	5927	0,5	B10EVX	7335						
SIMSON													
Albatros	50		B8HS	5510	0,4	B8HVX	2634	205	BR8HIX				7001
AT 50	50	09.90 -	B8HS	5510	0,6	B8HVX	2634	205	BR8HIX				7001

					Order No.		Platin 	Order No.	Quick-No.	Iridium 	Order No.
SIMSON											
Bunny 50	50	01.87 -12.90	B8HS	5510	0,6	B8HVX	2634	205	BR8HIX	7001	
Habicht 25	50		B8HS	5510	0,4	B8HVX	2634	205	BR8HIX	7001	
Habicht 50	50		B8HS	5510	0,4	B8HVX	2634	205	BR8HIX	7001	
Habicht 50 Basic	50		B8HS	5510	0,4	B8HVX	2634	205	BR8HIX	7001	
Habicht 50 s	50		B8HS	5510	0,4	B8HVX	2634	205	BR8HIX	7001	
Kleinkraftrad	50		B8HS	5510	0,4	B8HVX	2634	205	BR8HIX	7001	
S 50 B1	50	01.75 -12.80	B8HS	5510	0,6	B8HVX	2634	205	BR8HIX	7001	
S 51 Enduro	50	01.81 -12.90	B8HS	5510	0,6	B8HVX	2634	205	BR8HIX	7001	
S 51 B2-4	50	01.82 -12.90	B8HS	5510	0,6	B8HVX	2634	205	BR8HIX	7001	
S 53	50	09.90 -	B8HS	5510	0,6	B8HVX	2634	205	BR8HIX	7001	
Sperber 50 Basic	50		B8HS	5510	0,4	B8HVX	2634	205	BR8HIX	7001	
SR 50 , 1B ,C,CE	50	09.90 -	B8HS	5510	0,6	B8HVX	2634	205	BR8HIX	7001	
SR 50 CC , CCE	50	01.93 -	B8HS	5510	0,6	B8HVX	2634	205	BR8HIX	7001	
SR 50	50	01.85 -12.90	B8HS	5510	0,6	B8HVX	2634	205	BR8HIX	7001	
SR 50 XC , XCE , XG	50	06.93 -	B8HS	5510	0,6	B8HVX	2634	205	BR8HIX	7001	
Star 25	50	96 -	B8HS	5510	0,4	B8HVX	2634	205	BR8HIX	7001	
Star 25 Base E	50	96 -	B8HS	5510	0,4	B8HVX	2634	205	BR8HIX	7001	
Star Classic 50	50	96 -	B8HS	5510	0,4	B8HVX	2634	205	BR8HIX	7001	
Star Classic 50 Hot Summer	50	96 -	B8HS	5510	0,4	B8HVX	2634	205	BR8HIX	7001	
Trucky SD 50 CT	50		B8HS	5510	0,4	B8HVX	2634	205	BR8HIX	7001	
GS 75/1	70	01.75 -12.90	B8HS	5510	0,6	B8HVX	2634	205	BR8HIX	7001	
Leichtkraftrad	70		B8HS	5510	0,4	B8HVX	2634	205	BR8HIX	7001	
S 70 C,C,E/2	70	01.80 -12.90	B8HS	5510	0,6	B8HVX	2634	205	BR8HIX	7001	
Habicht 80	80		B8HS	5510	0,4	B8HVX	2634	205	BR8HIX	7001	
Habicht 80 Basic	80		B8HS	5510	0,4	B8HVX	2634	205	BR8HIX	7001	
Habicht 80 s	80		B8HS	5510	0,4	B8HVX	2634	205	BR8HIX	7001	
Hot Summer 80	80	96 -	B8HS	5510	0,4	B8HVX	2634	205	BR8HIX	7001	
Sperber 80 Basic	80		B8HS	5510	0,4	B8HVX	2634	205	BR8HIX	7001	
Star Classic 80	80	96 -	B8HS	5510	0,4	B8HVX	2634	205	BR8HIX	7001	
SOLO											
712 Mofa	48		BR6HS	3922	0,7			209	BR6HIX	3419	
713 Moped	48		BR7HS	4122	0,7			211	BR7HIX	7067	
722 Mofa	48		BR6HS	3922	0,7			209	BR6HIX	3419	
723 Moped	48		BR7HS	4122	0,7			211	BR7HIX	7067	
SPARTA											
Buddy	50		B6HS	4510	0,6	B6HVX	7435	203	BR6HIX	3419	
Happy	50		B6HS	4510	0,6	B6HVX	7435	203	BR6HIX	3419	
Lucky	50		B6HS	4510	0,6	B6HVX	7435	203	BR6HIX	3419	
Sport 2V	50		B6HS	4510	0,6	B6HVX	7435	203	BR6HIX	3419	
Sport 3V	50		B6HS	4510	0,6	B6HVX	7435	203	BR6HIX	3419	
Tour Automatica	50		B6HS	4510	0,6	B6HVX	7435	203	BR6HIX	3419	
STARFLITE											
25 (Laura M48-15B)	50		B6HS	4510	0,6	B6HVX	7435	203	BR6HIX	3419	
40 (Laura M48-11B)	50		B6HS	4510	0,6	B6HVX	7435	203	BR6HIX	3419	
Bronco	50		B6HS	4510	0,6	B6HVX	7435	203	BR6HIX	3419	
City Laura M48-15B	50		B6HS	4510	0,6	B6HVX	7435	203	BR6HIX	3419	
GTM (F&S 501 BKF)	50		B6HS	4510	0,6	B6HVX	7435	203	BR6HIX	3419	
GTS (F&S 50SA)	50		B8HS	5510	0,5	B8HVX	2634	205	BR8HIX	7001	
Tramp (Laura M48-15)	50		B6HS	4510	0,6	B6HVX	7435	203	BR6HIX	3419	

				Order No.		Platin 	Order No.	Quick-No. 	Iridium	Order No.
SUNDIRO										
Phönix XDZ 125 TN	125	96 -	DR8EA	7162	0,6	DR8EVX	6354		DR8EIX	6681
SUZUKI										
A 50 K	50		BR8HS	4322	0,7	BR8HVX	6265	212	BR8HIX	7001
A 50 P	50		BR7HS	4122	0,7			211	BR7HIX	7067
AE 50	50	93 -	BPR6HS	7022	0,7	BPR6HVX	2740	214	BPR6HIX	4085
AJ 50	50	95 -	BPR7HS	6422	0,6	BPR7HVX	2938	215	BPR7HIX	5944
AJ 50 ZZ	50	95 -	BPR7HS	6422	0,6	BPR7HVX	2938	215	BPR7HIX	5944
AP 50 (CA1JA)	50	95 -	BPR6HS	7022	0,7	BPR6HVX	2740	214	BPR6HIX	4085
CL 50 DO	50		BP4HS	3611	0,7					
CP 50 (CA14C/E)	50		BPR6HS	7022	0,7	BPR6HVX	2740	214	BPR6HIX	4085
CP 50 H-J,L/M/N	50		BPR6HS	7022	0,7	BPR6HVX	2740	214	BPR6HIX	4085
CS 50	50		BPR4HS	7823	0,7					
CX 50	50		BPR6HS	7022	0,7	BPR6HVX	2740	214	BPR6HIX	4085
CY 50	50		BPR6HS	7022	0,7	BPR6HVX	2740	214	BPR6HIX	4085
DM 50	50		BP6HS	4511	0,7	BP6HVX	4635		BPR6HIX	4085
DR Big 50	50	89 -	BR7HS	4122	0,7			211	BR7HIX	7067
DV 50	50		BP6ES	7811	0,7	BP6EVX	5832		BPR6EIX	6637
FA 50	50		BPR4HS	7823	0,7					
FR 50	50		BPR4HS	7823	0,7					
FS 50	50		BP4HA	3511	0,7					
FZ 50	50		BPR4HS	7823	0,7					
GT 50	50		BP6HS	4511	0,7	BP6HVX	4635		BPR6HIX	4085
JR 50	50	95 -	BPR4HS	7823	0,6					
JR 50	50	93 - 94	BP4H	3310	0,7					
JR 50 (JA143)	50		BPR4HS	7823	0,7					
K 50	50		BP7HS	5111	0,7	BP7HVX	7468		BPR7HIX	5944
Katana AY50 aircooled	50	97 -	BPR6HS	7022	0,7	BPR6HVX	2740	214	BPR6HIX	4085
Katana AY50 water (Spain)	50	97 -	BPR7HS	6422	0,7	BPR7HVX	2938	215	BPR7HIX	5944
Katana AY50 watercooled	50	97 -	BPR6HS	7022	0,7	BPR6HVX	2740	214	BPR6HIX	4085
Maxi 50	50		B7HS	5110	0,6	B7HVX	7836	204	BR7HIX	7067
OR 50	50		BP6HS	4511	0,7	BP6HVX	4635		BPR6HIX	4085
RB 50 GAG	50	88 - 88	CR6HS	7023	0,7			223	CR6HIX	7274
RG 50 KE	50		BP8ES	2912	0,7	BP8EVX	2671			
RG 50 W	50		BPR8ES	3923	0,8	BPR8EVX	5573	213		
RM 50	50	90 -	BR7HS	4122	0,7			211	BR7HIX	7067
RM 50	50	- 89	B7HS	5110	0,7	B7HVX	7836	204	BR7HIX	7067
RV 50	50		BP6HS	4511	0,7	BP6HVX	4635		BPR6HIX	4085
Suzy	50	95 -	BPR6HS	7022	0,7	BPR6HVX	2740	214	BPR6HIX	4085
TR 50	50		BP4H	3310	0,7					
TR 50 S Magic	50	98 -	BPR6HS	7022	0,7	BPR6HVX	2740	214	BPR6HIX	4085
TS 50 12,7mm	50		BP6HS	4511	0,7	BP6HVX	4635		BPR6HIX	4085
TS 50 19,0mm	50		BP6ES	7811	0,8	BP6EVX	5832		BPR6EIX	6637
TS 50 ER	50		BP6HS	4511	0,7	BP6HVX	4635		BPR6HIX	4085
TS 50 XK (SA11C)	50		BP6ES	7811	0,7	BP6EVX	5832		BPR6EIX	6637
ZR 50	50		BP6ES	7811	0,8	BP6EVX	5832		BPR6EIX	6637
RM 65	65	04 -	BR10EG	3830	0,6					
CS 80	80		BPR6HS	7022	0,7	BPR6HVX	2740	214	BPR6HIX	4085
DS 80	80	93 - 94	B7ES	1111	0,7	B7EVX	6934			
DS 80	80	95 -	BP7ES	2412	0,6	BP7EVX	7270	206	BPR7EIX	4055
FR 80	80		BPR6HS	7022	0,7	BPR6HVX	2740	214	BPR6HIX	4085
GT 80 EX/LX	80		B8ES	2411	0,7	B8EVX	7051	201	BR8EIX	5044



Order No.



Gold-Palladium



Platin

Order No.

Quick-No.







Iridium



Order No.

SUZUKI

JR 80 (K2)	80	02 -	BR7ES	5122	0,8	BR7EVX	4556				
RG 80 G (D) (NC11A)	80		BP7ES	2412	0,8	BP7EVX	7270	206	BPR7EIX	4055	
RG 80 Gamma	80		BP7ES	2412	0,8	BP7EVX	7270	206	BPR7EIX	4055	
RG 80 WF	80		BPR7ES	2023	0,8	BPR7EVX	5565		BPR7EIX	4055	
RM 80	80	93 -	B10ES	7928	0,8	B10EVX	7335		BR10EIX	6801	
RM 80 H	80		BR9ES	5722	0,8	BR9EVX	1265	208	BR9EIX	3981	
RM 80 X	80	- 90	BR9ES	5722	0,8	BR9EVX	1265	208	BR9EIX	3981	
RM 80 X	80	91 -	BR10ES	4832	0,7	BR10EVX	3788		BR10EIX	6801	
TS 80 ERX	80		B7ES	1111	0,8	B7EVX	6934				
TS 80 X (SA11A)	80		BP7ES	2412	0,7	BP7EVX	7270	206	BPR7EIX	4055	
TS 80 XE-H	80		BP8ES	2912	0,8	BP8EVX	2671				
RM 85 (K2)(K3)(K4)	85	02 -	BR10ES	4832	0,8	BR10EVX	3788		BR10EIX	6801	
FM 90	90		BPR6HS	7022	0,7	BPR6HVX	2740	214	BPR6HIX	4085	
RV 90	90		BP6HS	4511	0,6	BP6HVX	4635		BPR6HIX	4085	
A 100	100	95 -	BP6HS	4511	0,6	BP6HVX	4635		BPR6HIX	4085	
FB 100 / D	100	95 -	D8EA	2120	0,6	D8EVX	2850	216	DR8EIX	6681	
GP 100	100		B8HS	5510	0,7	B8HVX	2634	205	BR8HIX	7001	
RM 100	100				0,6	B9EGV	5827				
RM 100 X	100				0,6	B9EGV	5827				
TS 100 X	100	78 -	B8ES	2411	0,7	B8EVX	7051	201	BR8EIX	5044	
TS 100 X	100	- 77	B8HS	5510	0,7	B8HVX	2634	205	BR8HIX	7001	
DR-Z 110 (LX110A)	111	03 -	CR6HSA	2983	0,7				CR6HIX	7274	
125 Van Van	125	03 -	CR8E	1275	0,6	CR8EVX	6487	226	CR8EIX	4218	
CS 125	125		DR8ESL	2923	0,7	DR8EVX	6354	218	DR8EIX	6681	
DR 125 S/L-N	125	91 -	DR8ESL	2923	0,7	DR8EVX	6354	218	DR8EIX	6681	
DR 125 SE (SF44A)	125	95 -	DR8EA	7162	0,6	DR8EVX	6354		DR8EIX	6681	
DR 125 SJ (SF43B)	125		DR8ESL	2923	0,7	DR8EVX	6354	218	DR8EIX	6681	
GN 125 V (NF41A)	125	97 -	DR8EA	7162	0,7	DR8EVX	6354		DR8EIX	6681	
GN 125	125	91 -	DR8ESL	2923	0,7	DR8EVX	6354	218	DR8EIX	6681	
GP 125	125		B8HS	5510	0,7	B8HVX	2634	205	BR8HIX	7001	
GS 125 S	125		DR8ESL	2923	0,9	DR8EVX	6354	218	DR8EIX	6681	
GS 125 S	125	99 -	DR8EA	7162	0,7	DR8EVX	6354		DR8EIX	6681	
GT 125-E	125		B8HS	5510	0,7	B8HVX	2634	205	BR8HIX	7001	
GZ 125 / U (AP) Marauder	125	99 -	DR8EA	7162	0,7	DR8EVX	6354		DR8EIX	6681	
RG 125	125	01.85 -	BR9ES	5722	0,7	BR9EVX	1265	208	BR9EIX	3981	
RM 125	125	- 86			0,6	B9EGV	5827				
RM 125	125	87 - 92			0,6	BR9EVX	1265		BR9EIX	3981	
RM 125	125	96 -	R6918B-8	4492	0,6						
RM 125	125	93 - 95	R4118S-9	3245	0,6						
RC 125	125		B7HS	5110	0,6	B7HVX	7836	204	BR7HIX	7067	
RV 125	125		B7HS	5110	0,6	B7HVX	7836	204	BR7HIX	7067	
TS 125 ER N	125	79 - 79	BP8ES	2912	0,8	BP8EVX	2671				
TS 125 R	125		BR9ES	5722	0,8	BR9EVX	1265	208	BR9EIX	3981	
TS 125 X	125		BR8ES	5422	0,8	BR8EVX	1262	207	BR8EIX	5044	
TS 125 ER T, X	125	80 - 83	B8ES	2411	0,8	B8EVX	7051	201	BR8EIX	5044	
TS 125 C,C2	125	01.78 - 78	BR8ES	5422	0,8	BR8EVX	1262	207	BR8EIX	5044	
TS 125 K, L, M	125	73 - 75	B7HS	5110	0,8	B7HVX	7836	204	BR7HIX	7067	
TS 125 X E	125	84 -	B8ES	2411	0,8	B8EVX	7051	201	BR8EIX	5044	
TS 125 N	125	79 - 79	B8ES	2411	0,8	B8EVX	7051	201	BR8EIX	5044	
TS 125 A / B	125	76 -12.77	B8HS	5510	0,5	B8HVX	2634	205	BR8HIX	7001	
TU 125 XT (AZ)	125	99 -	DR8EA	7162	0,7	DR8EVX	6354		DR8EIX	6681	
UE 125 C (WVBH)	125	01 -	CR7E	4578	0,6			225	CR7EIX	7385	

					Order No.		Platin 	Order No.	Quick-No. 	Iridium	Order No.
SUZUKI											
VL 125 LC Intruder	125	00 -	CR8E	1275	0,6	CR8EVX	6487	226	CR8EIX		4218
PE 175	175	79 -			0,6	B10EGV	5927				
PE 175	175	78 - 78			0,6	B8EGV	5627				
GT 185	185		B7HS	5110	0,7	B7HVX	7836	204	BR7HIX		7067
TS 185 ER	185	93 -	BP7ES	2412	0,8	BP7EVX	7270	206	BPR7EIX		4055
DR 200 SZ	200	95 -	DR8EA	7162	0,6	DR8EVX	6354		DR8EIX		6681
GT 200	200		B8ES	2411	0,8	B8EVX	7051	201	BR8EIX		5044
TS 200	200		BR9ES	5722	0,8	BR9EVX	1265	208	BR9EIX		3981
DR 250	250	91 -	DPR9EA-9	5329	0,9	DPR9EVX-9	3854	222	DPR9EIX-9		5545
DR 250 S	250	90 -	DPR9EA-9	5329	0,9	DPR9EVX-9	3854	222	DPR9EIX-9		5545
DR 250 S (SJ42A)	250		DR8ESL	2923	0,7	DR8EVX	6354	218	DR8EIX		6681
DR 250 SZ	250	95 -	DPR9EA-9	5329	0,8	DPR9EVX-9	3854	222	DPR9EIX-9		5545
DR 250 SZ-H	250		DR8ESL	2923	0,7	DR8EVX	6354	218	DR8EIX		6681
GN 250 EZ-J	250		DR8ESL	2923	0,7	DR8EVX	6354	218	DR8EIX		6681
GN 250 L-N (NJ42A)	250	- 97	DR8ESL	2923	0,7	DR8EVX	6354	218	DR8EIX		6681
GN 250 (NJ42A)	250	98 -	DR8EA	7162	0,7	DR8EVX	6354		DR8EIX		6681
GNX 250	250	01.82 - 12.84	DR8ESL	2923	0,7	DR8EVX	6354	218	DR8EIX		6681
GSX 250 EZ (GJ53B)	250		DR8ES	5423	0,7	DR8EVX	6354	217	DR8EIX		6681
GSX 250 L	250		DR8ES	5423	0,7	DR8EVX	6354	217	DR8EIX		6681
GSX 250 T/ET 1	250		DR8ES	5423	0,7	DR8EVX	6354	217	DR8EIX		6681
GZ 250 (JS1AR)	250	99 -	DR8EA	7162	0,7	DR8EVX	6354		DR8EIX		6681
PE 250	250	- 78			0,6	B8EGV	5627				
PE 250	250	80 -			0,6	B10EGV	5927				
PE 250	250	79 - 79			0,6	B9EGV	5827				
RG 250 CH/FCH (GJ21D)	250		BR9ES	5722	0,7	BR9EVX	1265	208	BR9EIX		3981
RG 250 G-CH	250		BR9ES	5722	0,8	BR9EVX	1265	208	BR9EIX		3981
RG 250 WE (GJ21A)	250		BR9ES	5722	0,8	BR9EVX	1265	208	BR9EIX		3981
RGV 250 L (VJ21A)	250	90 - 90	BR9ES	5722	0,8	BR9EVX	1265	208	BR9EIX		3981
RGV 250 M-N (VJ22B)	250	91 -	BR9ECM	3252	0,8	BR9ECMVX	2434				
RM 250	250	82 - 92			0,6	B8EGV	5627				
RM 250	250	- 81			0,6	B9EGV	5827				
RM 250	250	93 - 00	R4118S-8	3236	0,6						
RM 250 (JS1R,J18A)(K2,K3,K4)	250	01 - 03	BR8EG	3130	0,6						
RMX 250	250				0,6	B9EGV	5827				
RM-Z 250	250	04 -	CR8EB	7784	0,6	CR8EVX	6487		CR8EIX		4218
TS 250 X G-K (SJ11D)	250		BR9ES	5722	0,8	BR9EVX	1265	208	BR9EIX		3981
350 Goose	350	93 -	CR9EK	4548	0,7			230	CR9EIX		3521
DR 350	350	95 -	CR9EK	4548	0,6			230	CR9EIX		3521
DR 350 S/L-P (SK42B)	350	91 -	DPR9EA-9	5329	0,9	DPR9EVX-9	3854	222	DPR9EIX-9		5545
DR 350 SH/N/S	350	90 -	DPR9EA-9	5329	0,9	DPR9EVX-9	3854	222	DPR9EIX-9		5545
DR 350 SZ	350	95 -	CR9EK	4548	0,6			230	CR9EIX		3521
DR 400 S	400	01.80 - 12.83	DR8ESL	2923	0,7	DR8EVX	6354	218	DR8EIX		6681
DR-Z 400 (WVBC)	400	00 -	CR8E	1275	0,6	CR8EVX	6487	226	CR8EIX		4218
DR-Z 400 S (WVBC)	400	00 -	CR8E	1275	0,6	CR8EVX	6487	226	CR8EIX		4218
DR-Z 400 SM K5 (WVB8)	400	05 -	CR8E	1275	0,6	CR8EVX	6487	226	CR8EIX		4218
GN 400 TD-X	400		DR8ESL	2923	0,7	DR8EVX	6354	218	DR8EIX		6681
GS 400 R/C/EC/N/EN	400		B8ES	2411	0,7	B8EVX	7051	201	BR8EIX		5044
GS 400 TX	400		B8ES	2411	0,7	B8EVX	7051	201	BR8EIX		5044
GSF 400 (BANDIT GK75B)	400	92 -	CR9EK	4548	0,7			230	CR9EIX		3521
GSF 400 (BANDIT GK75B)	400	- 92	CR8EK	3478	0,7				CR8EIX		4218
GSX 400 E (GS40X)	400	01.83 -	DR8ESL	2923	0,7	DR8EVX	6354	218	DR8EIX		6681
GSX 400 FW	400		CR8HS	7423	0,7	CR8HVX	7236		CR8HIX		7669



SUZUKI

				Order No.		Order No.	Quick-No.		Order No.	
GSX 400 FX	400		DR8ESL	2923	0,6	DR8EVX	6354	218	DR8EIX	6681
GSX 400 LX	400		DR8ESL	2923	0,7	DR8EVX	6354	218	DR8EIX	6681
GSX 400 S	400		DR8ESL	2923	0,6	DR8EVX	6354	218	DR8EIX	6681
GSX 400 SE/EF (GK53C)	400		DR8ESL	2923	0,7	DR8EVX	6354	218	DR8EIX	6681
GSX-R400	400		CR8EK	3478	0,7				CR8EIX	4218
GSX-R400	400	93 -	CR9EK	4548	0,7			230	CR9EIX	3521
VS 400	400	95 -	DPR8EA-9	4929	0,8	DPR8EVX-9	2872	221	DPR8EIX-9	2202
GS 450 E/ES (GS450)	450		B8ES	2411	0,7	B8EVX	7051	201	BR8EIX	5044
GS 450 L (GL51D)	450		B8ES	2411	0,7	B8EVX	7051	201	BR8EIX	5044
GS 450 LT/X (GS450)	450		B8ES	2411	0,7	B8EVX	7051	201	BR8EIX	5044
GS 450 SF	450		BR8ES	5422	0,7	BR8EVX	1262	207	BR8EIX	5044
GS 450 TX	450		B8ES	2411	0,7	B8EVX	7051	201	BR8EIX	5044
RM-Z 450 K5 (RL41A)	450	05 -			1,0				CR8EIB-10	4948
RM 495	495				0,5	B8EGV	5627			
DR 500 S (D)	500		DR8ESL	2923	0,7	DR8EVX	6354	218	DR8EIX	6681
DR 500 S (I)	500		D8EA	2120	0,7	D8EVX	2850	216	DR8EIX	6681
DR 500 SX-Z	500		DR8ESL	2923	0,7	DR8EVX	6354	218	DR8EIX	6681
GS 500 E	500	- 00	B8ES	2411	0,7	B8EVX	7051	201	BR8EIX	5044
GS 500 E (GM51B)	500	93 - 00	DPR8EA-9	4929	0,9	DPR8EVX-9	2872	221	DPR8EIX-9	2202
GS 500 F	500	04 -	DPR8EA-9	4929	0,9	DPR8EVX-9	2872	221	DPR8EIX-9	2202
RG 500	500	87 - 87	BR9ES	5722	0,8	BR9EVX	1265	208	BR9EIX	3981
RM 500	500				0,5	B8EGV	5627			
GS 550 MX/LN/T	550		B8ES	2411	0,7	B8EVX	7051	201	BR8EIX	5044
GSX 550 (GN71D)	550		DR8ES	5423	0,7	DR8EVX	6354	217	DR8EIX	6681
GSX 550 EF (I)	550		DP9EA-9	6629	0,9	DP9EVX-9	3331		DPR9EIX-9	5545
GT 550	550	01.73 -12.77	B8ES	2411	0,7	B8EVX	7051	201	BR8EIX	5044
DR 600	600		DPR9EA-9	5329	0,9	DPR9EVX-9	3854	222	DPR9EIX-9	5545
DR 600 R Djebel (I)	600		DPR9EA-9	5329	0,9	DPR9EVX-9	3854	222	DPR9EIX-9	5545
DR 600 S (SN41A)	600		DPR9EA-9	5329	0,9	DPR9EVX-9	3854	222	DPR9EIX-9	5545
GSF 600 Y (WVA8)	600	00 -	CR9EK	4548	0,6			230	CR9EIX	3521
GSF 600 (GN77B)	600	95 -	CR9EK	4548	0,7			230	CR9EIX	3521
GSF 600 (K2)	600	02 -	CR9EK	4548	0,6			230	CR9EIX	3521
GSF 600 S (K2)	600	02 -	CR9EK	4548	0,6			230	CR9EIX	3521
GSR 600 (K6)	600	06 -	CR9E	6263	0,7	CR9EVX	5943	227	CR9EIX	3521
GSX 600 F (W)	600	98 -	CR9EK	4548	0,7			230	CR9EIX	3521
GSX 600 F/FU/FU2 (GN27B)	600		DR8ES	5423	0,7	DR8EVX	6354	217	DR8EIX	6681
GSX-R 600 (K6)	600	06 -	CR9E	6263	0,7	CR9EVX	5943	227	CR9EIX	3521
GSX-R 600 (WVB2)	600	04 -	CR9E	6263	0,7	CR9EVX	5943	227	CR9EIX	3521
GSX-R 600 (JS1AD)	600	97 - 00	CR9E	6263	0,7	CR9EVX	5943	227	CR9EIX	3521
GSX-R 600 (W) (JS1BG)(WVBG)	600	98 -	CR9E	6263	0,7	CR9EVX	5943	227	CR9EIX	3521
RF 600 R / RU (GN76B)	600	93 -	CR9E	6263	0,7	CR9EVX	5943	227	CR9EIX	3521
VS 600 (VN51B)	600	95 -	DPR8EA-9	4929	0,9	DPR8EVX-9	2872	221	DPR8EIX-9	2202
DL 650 V-strom (K4)	650	04 -	CR8E	1275	0,8	CR8EVX	6487	226	CR8EIX	4218
DR 650 R/RU (SP41B)	650		DPR9EA-9	5329	0,9	DPR9EVX-9	3854	222	DPR9EIX-9	5545
DR 650 R/RU (SP44B)	650		DPR9EA-9	5329	0,9	DPR9EVX-9	3854	222	DPR9EIX-9	5545
DR 650 RE (SP45B)	650	94 -	DPR9EA-9	5329	0,9	DPR9EVX-9	3854	222	DPR9EIX-9	5545
DR 650 RS/RSU (SP42B)	650	91 -	DPR9EA-9	5329	0,9	DPR9EVX-9	3854	222	DPR9EIX-9	5545
DR 650 RSE/RSEU (SP43B)	650	90 -	DPR9EA-9	5329	0,9	DPR9EVX-9	3854	222	DPR9EIX-9	5545
DR 650 SET	650	96 - 00	CR9E	6263	0,6	CR9EVX	5943	227	CR9EIX	3521
GR 650 D/XD/XF (GP51A)	650		DR8ESL	2923	0,6	DR8EVX	6354	218	DR8EIX	6681
GS 650 G	650		DR8ESL	2923	0,6	DR8EVX	6354	218	DR8EIX	6681
GSF 650 / S K5 (WVB5)	650	05 -	CR8EK	3478	0,6				CR8EIX	4218



Order No.



Gold-Palladium



Platin

Order No.

Quick-No.

Iridium



Order No.

SUZUKI

LS 650 (NP41B)	650	-	00	DPR8EA-9	4929	0,9	DPR8EVX-9	2872	221	DPR8EIX-9	2202	
SV 650 (K3)	650	03	-	CR8E	1275	0,7	CR8EVX	6487	226	CR8EIX	4218	
SV 650 S (K3)	650	03	-	CR8E	1275	0,7	CR8EVX	6487	226	CR8EIX	4218	
SV 650 S (AV)	650	99	-	CR9E	6263	0,6	CR9EVX	5943	227	CR9EIX	3521	
SV 650 SU (AV)	650	99	-	CR9E	6263	0,6	CR9EVX	5943	227	CR9EIX	3521	
XF 650 (JS1AC) Freewind	650	97	-	CR9EK	4548	0,7			230	CR9EIX	3521	
DR 750 S (DR BIG SR41B)	750			DPR9EA-9	5329	0,9	DPR9EVX-9	3854	222	DPR9EIX-9	5545	
GS 750 D/E/L	750			B8ES	2411	0,7	B8EVX	7051	201	BR8EIX	5044	
GSX 750 E	750			DR8ESL	2923	0,6	DR8EVX	6354	218	DR8EIX	6681	
GSX 750 E (I)	750			D8EA	2120	0,7	D8EVX	2850	216	DR8EIX	6681	
GSX 750 EF	750	-	85	DR8ESL	2923	0,7	DR8EVX	6354	218	DR8EIX	6681	
GSX 750 ES (I)	750			D8EA	2120	0,7	D8EVX	2850	216	DR8EIX	6681	
GSX 750 F (GR78A)	750	89	-	JR9C	6193	0,7				DR9EIX	4772	
GSX 750 S	750			DR8ESL	2923	0,6	DR8EVX	6354	218	DR8EIX	6681	
GSX 750 S Katana (I)	750			DR8EA	7162	0,7	DR8EVX	6354	218	DR8EIX	6681	
GSX 750 T	750			DR8ESL	2923	0,6	DR8EVX	6354	218	DR8EIX	6681	
GSX 750 (W)(AK)	750	98	-	CR9EK	4548	0,7			230	CR9EIX	3521	
GSX R 750 (GR75A)	750	-	87	DR8ES	5423	0,7	DR8EVX	6354	217	DR8EIX	6681	
GSX R 750 (GR77B)	750	88	-	JR9C	6193	0,7				DR9EIX	4772	
GSX-R 750 Y (WVBD)	750	00	-	CR9E	6263	0,7	CR9EVX	5943	227	CR9EIX	3521	
GSX-R 750 (K6)	750	06	-	CR9E	6263	0,7	CR9EVX	5943	227	CR9EIX	3521	
GSX-R 750 (WVB3)	750	04	-	CR9E	6263	0,7	CR9EVX	5943	227	CR9EIX	3521	
GSX-R 750 (GR7AB)	750	91	-	CR10EK	2360	0,7				CR10EIX	6482	
GSX-R 750 J-K	750			JR9B	3188	0,7			224	DR9EIX	4772	
GSX-R 750 R	750	89	-	CR10EK	2360	0,7				CR10EIX	6482	
GSX-R 750 RG (GR75A)(GR79B)	750			DR8ES	5423	0,7	DR8EVX	6354	217	DR8EIX	6681	
GSX-R 750 T	750	96	-	CR9E	6263	0,6	CR9EVX	5943	227	CR9EIX	3521	
GSX-R 750 (W)	750	98	-	CR9E	6263	0,7	CR9EVX	5943	227	CR9EIX	3521	
GSX-R 750 W	750	95	-	CR9E	6263	0,6	CR9EVX	5943	227	CR9EIX	3521	
GSX-R 750 W (GR7BB)	750	-	93	CR9EK	4548	0,7			230	CR9EIX	3521	
GT 750	750			B7ES	1111	0,5	B7EVX	6934				
VS 750 GL/H/J-K	750			DPR9EA-9	5329	0,9	DPR9EVX-9	3854	222	DPR9EIX-9	5545	
DR 800 S/SU L (SR42B)	773	90	-	DPR9EA-9	5329	0,9	DPR9EVX-9	3854	222	DPR9EIX-9	5545	
DR 800 S/SU M-N (SR43B)	800			DPR9EA-9	5329	0,9	DPR9EVX-9	3854	222	DPR9EIX-9	5545	
VL 800 (K2;K5) (WVBM) Intruder C800	800	01	-	DPR7EA-9	5129	0,9	DPR7EVX-9	7682	220	DPR7EIX-9	7803	
VS 800 N-P (VS52B)	800	92	-	00	DPR8EA-9	4929	0,9	DPR8EVX-9	2872	221	DPR8EIX-9	2202
VX 800/U (VS51B)	800			DPR8EA-9	4929	0,9	DPR8EVX-9	2872	221	DPR8EIX-9	2202	
VZ 800 (JS1AF)Marauder	800	97	-	DPR8EA-9	4929	0,9	DPR8EVX-9	2872	221	DPR8EIX-9	2202	
VZ 800/U K5 Intruder M800 (WVB4)	800	05	-	DPR7EA-9	5129	0,9	DPR7EVX-9	7682	220	DPR7EIX-9	7803	
GS 850 G (GS72A)	850			B8ES	2411	0,7	B8EVX	7051	201	BR8EIX	5044	
GS 850 GL	850			B8ES	2411	0,7	B8EVX	7051	201	BR8EIX	5044	
GS 850 GT E-G (GS72A)	850			B9ES	2611	0,7	B9EVX	7254	202	BR9EIX	3981	
RF 900 R (GT73B)	900	94	-	CR9E	6263	0,7	CR9EVX	5943	227	CR9EIX	3521	
GS 1000 D/E/H/S-1980/GL/GX	1000			B8ES	2411	0,7	B8EVX	7051	201	BR8EIX	5044	
GSX 1000 E	1000	86	-	DPR9EA-9	5329	0,9	DPR9EVX-9	3854	222	DPR9EIX-9	5545	
GSX R 1000	1000	-	99	JR9B	3188	0,7			224	DR9EIX	4772	
GSX R 1000 (WVBL) Fuel Injection	1000	01	-	CR9E	6263	0,7	CR9EVX	5943	227	CR9EIX	3521	
GSX-R 1000 (K3) (WVBZ)	1000	03	-	CR9E	6263	0,7	CR9EVX	5943	227	CR9EIX	3521	
GSX-R 1000	1000	05	-	CR9E	6263	0,7	CR9EVX	5943	227	CR9EIX	3521	
SV 1000 (WVBX)	1000	03	-	CR8EK	3478	0,7				CR8EIX	4218	
SV 1000 S (WVBX)	1000	03	-	CR8EK	3478	0,7				CR8EIX	4218	
TL 1000 R (W)	1000	98	-	CR9EK	4548	0,7			230	CR9EIX	3521	



Order No.



Gold-Palladium



Platin

Order No.

Quick-No.

Iridium



Order No.

SUZUKI

TL 1000 S (JS1AG)	1000	97 - 00	CR8EK	3478	0,7				CR8EIX	4218	
V-Strom 1000	1000	02 -	CR8EK	3478	0,7				CR8EIX	4218	
GS 1100 E,GSX 1100 E	1100		DR8ESL	2923	0,6	DR8EVX	6354	218	DR8EIX	6681	
GS 1100 G /GG (GU71A)	1100		B8ES	2411	0,8	B8EVX	7051	201	BR8EIX	5044	
GS 1100 GT	1100		B8ES	2411	0,7	B8EVX	7051	201	BR8EIX	5044	
GSX 1100 EFE (I)	1100		D8EA	2120	0,7	D8EVX	2850	216	DR8EIX	6681	
GSX 1100 EFG/ESG/EG(GV71C)	1100		DR8ES	5423	0,7	DR8EVX	6354	217	DR8EIX	6681	
GSX 1100 EZ/ESD (GU71B)	1100		DR8ESL	2923	0,6	DR8EVX	6354	218	DR8EIX	6681	
GSX 1100 F (GV72C)72-100kW	1100		JR9B	3188	0,7				224	DR9EIX	4772
GSX 1100 G L-N (GV74A)	1100		JR9B	3188	0,7				224	DR9EIX	4772
GSX 1100 S/SZ Kata.(GS110XS)	1100		D8EA	2120	0,7	D8EVX	2850	216	DR8EIX	6681	
GSX-K 1100 (I)	1100		JR9B	3188	0,7				224	DR9EIX	4772
GSX R-1100 W (GU75C)	1100	93 -	CR9E	6263	0,7	CR9EVX	5943	227	CR9EIX	3521	
GSX-R 1100 (GU74C,GV73C)	1100		JR9B	3188	0,7				224	DR9EIX	4772
GS 1150 EF (NL,I)	1150		D9EA	2420	0,7	D9EVX	2834			DR9EIX	4772
GS 1150 ES (NL,I)	1150		D9EA	2420	0,7	D9EVX	2834			DR9EIX	4772
GSX 1150 E	1150	86 -	DPR9EA-9	5329	0,9	DPR9EVX-9	3854	222	DPR9EIX-9	5545	
GSX 1150 E	1150	- 85	DR8ES	5423	0,7	DR8EVX	6354	217	DR8EIX	6681	
GSX 1150 EF	1150		DR8ES	5423	0,7	DR8EVX	6354	217	DR8EIX	6681	
GSX 1150 ES	1150		DR8ES	5423	0,7	DR8EVX	6354	217	DR8EIX	6681	
GSF 1200 / S (JS1A9..)(WVA9)	1200	01 -	JR9B	3188	0,7				224	DR9EIX	4772
GSF 1200 (K6)	1200	06 -	JR9B	3188	0,7				224	DR9EIX	4772
GSF 1200 /S/SA	1200	96 - 00	JR9B	3188	0,7				224	DR9EIX	4772
GSX 1200	1200		JR8B	7237	0,7					DR8EIX	6681
GV 1200 GL	1200	86 -	DR8ESL	2923	0,7	DR8EVX	6354	218	DR8EIX	6681	
GSX 1300 R Hayabusa (WV A1)	1300	99 -	CR9E	6263	0,7	CR9EVX	5943	227	CR9EIX	3521	
GSX 1400	1400	01 -	CR8EK	3478	0,7					CR8EIX	4218
VS 1400 GLP H-J (VX51L)	1400		DPR8EA-9	4929	0,9	DPR8EVX-9	2872	221	DPR8EIX-9	2202	
VL 1500 Intruder LC	1500	98 - 04	DPR7EA-9	5129	0,9	DPR7EVX-9	7682	220	DPR7EIX-9	7803	
VL 1500 K5 (WVAL) Intruder C 1500	1500	05 -	DPR7EA-9	5129	0,9	DPR7EVX-9	7682	220	DPR7EIX-9	7803	
VZ 1600 Marauder 1600	1600	04 -	DPR6EA-9	5531	0,9						
M 1800 R Intruder K6 (VZR1800)	1800	06 -	CR8EK	3478	0,7					CR8EIX	4218

SV

Dakar 2/3	35		BPM6A	7021	0,5					
Triciclo Mini-Dakar	35		BPM6A	7021	0,5					

SWM







TLM 125	125		BP5ES	6511	0,4	BP5EVX	5470		BPR5EIX	6597
TL 200	200		BP5ES	6511	0,4	BP5EVX	5470		BPR5EIX	6597
TL 240	240		BP5ES	6511	0,4	BP5EVX	5470		BPR5EIX	6597
TLM 320	320		BP5ES	6511	0,4	BP5EVX	5470		BPR5EIX	6597
TL 350	350		BP5ES	6511	0,4	BP5EVX	5470		BPR5EIX	6597



SYM







Husky	125	97 -	DR8EA	7162	0,7	DR8EVX	6354		DR8EIX	6681
-------	-----	------	-------	------	-----	--------	------	--	--------	------







TESTI

Amico (Minarelli V1)	50		B5HS	4210	0,5					
Carabo CR (8.5PS)	50		B8HS	5510	0,5	B8HVX	2634	205	BR8HIX	7001
Carabo(Minarelli P4A)	50		B6HS	4510	0,6	B6HVX	7435	203	BR6HIX	3419
Carabo(Minarelli P6CS)	50		B6HS	4510	0,6	B6HVX	7435	203	BR6HIX	3419

					Order No.		Gold-Palladium	Platin 	Order No.	Quick-No.	Iridium 	Order No.
TESTI												
Carabo(Minarelli P6RAD)	50		B6ES	7310	0,7		B6EVX	5136				
Champion Special(Minarelli P6CS)	50		B6HS	4510	0,6		B6HVX	7435	203		BR6HIX	3419
Champion Special(Minarelli P6RAD)	50		B6ES	7310	0,7		B6EVX	5136				
Champion(Minarelli P4/P6RAD)	50		B6ES	7310	0,7		B6EVX	5136				
Champion(Minarelli P4A/CS)	50		B6HS	4510	0,6		B6HVX	7435	203		BR6HIX	3419
Champion(Minarelli P6A/CS)	50		B6HS	4510	0,6		B6HVX	7435	203		BR6HIX	3419
Confort (Minarelli V1N)	50		B5HS	4210	0,5							
Confort(Minarelli P3NK)	50		B6HS	4510	0,6		B6HVX	7435	203		BR6HIX	3419
Corsa (8.5PS)	50		B8HS	5510	0,5		B8HVX	2634	205		BR8HIX	7001
Criquet (Minarelli V1AK/NK)	50		B5HS	4210	0,5							
Criquet(Minarelli P4A)	50		B6HS	4510	0,6		B6HVX	7435	203		BR6HIX	3419
Criquet(Minarelli P4CS/RAD)	50		B6ES	7310	0,7		B6EVX	5136				
Gran Prix(Minarelli P4A)	50		B6HS	4510	0,6		B6HVX	7435	203		BR6HIX	3419
IO (Minarelli V1AKS)	50		B5HS	4210	0,5							
Jeans(Minarelli P4/P6 RAD)	50		B6ES	7310	0,7		B6EVX	5136				
Mini Criquet (Minarelli V1N/AK)	50		B5HS	4210	0,5							
O.K.C. (Minarelli C2)	50		B5HS	4210	0,5							
O.K.S. (Minarelli V1N)	50		B5HS	4210	0,5							
Pull (Minarelli V1NK)	50		B5HS	4210	0,5							
Grand Touring (Minarelli)	80		B8HS	5510	0,5		B8HVX	2634	205		BR8HIX	7001
2000 Special	125		B8ES	2411	0,5		B8EVX	7051	201		BR8EIX	5044
Corsa	125		B8ES	2411	0,5		B8EVX	7051	201		BR8EIX	5044
Corsa Easy Rider	125		B8ES	2411	0,5		B8EVX	7051	201		BR8EIX	5044
TGB												
202T big wvvels	50	98 -	BPR7HS	6422	0,8		BPR7HVX	2938	215		BPR7HIX	5944
Ergon	50	98 -	BPR7HS	6422	0,8		BPR7HVX	2938	215		BPR7HIX	5944
202T Palio	125	98 -	C7HSA	4629	0,7		C7HVX	4533			CR7HIX	7544
TITAN												
Coyote	1573	97 - 03	BPR5ES	7422	0,7		BPR5EVX	4875			BPR5EIX	6597
Fat Bobber S&S engine	1573		BPR5ES-11	4424	1,1		BPR5EVX-11	2738			BPR5EIX-11	2115
Gecko	1573	97 - 03	BPR5ES	7422	0,7		BPR5EVX	4875			BPR5EIX	6597
Roadrunner	1573	97 - 03	BPR5ES	7422	0,7		BPR5EVX	4875			BPR5EIX	6597
Scorpion	1573	97 - 03	BPR5ES	7422	0,7		BPR5EVX	4875			BPR5EIX	6597
Sidewinder	1573	97 - 03	BPR5ES	7422	0,7		BPR5EVX	4875			BPR5EIX	6597
Custom Pro Street S&S engine	1753		BPR5ES-11	4424	1,1		BPR5EVX-11	2738			BPR5EIX-11	2115
Custom Rubber Mount Chopper S&S engine	1852		BPR5ES-11	4424	1,1		BPR5EVX-11	2738			BPR5EIX-11	2115
Custom Softail Chopper S&S engine	1852		BPR5ES-11	4424	1,1		BPR5EVX-11	2738			BPR5EIX-11	2115
Radical Rigid S&S engine	1852		BPR5ES-11	4424	1,1		BPR5EVX-11	2738			BPR5EIX-11	2115
Custom Rubber Mount Chopper S&S engine	2003		DCPR7E	3932	0,8		DCPR7EVX	1179			DCPR7EIX	6046
Custom Softail Chopper S&S engine	2003		DCPR7E	3932	0,8		DCPR7EVX	1179			DCPR7EIX	6046
Radical Rigid S&S engine	2003		DCPR7E	3932	0,8		DCPR7EVX	1179			DCPR7EIX	6046
TM												
Cross, Enduro	80	94 -	B9EG	3530	0,6		B9EGV	5827			BR9EIX	3981
125 EN	125	03 -	BR9EG	3230	0,6		BR9EVX	1265			BR9EIX	3981
Cross, Enduro	125	94 -	B10EG	3630	0,6		B10EGV	5927				
250 EN	250	03 -	BR8EG	3130	0,5							
250 EN-F	250	04 -	CR8E	1275	0,7		CR8EVX	6487	226		CR8EIX	4218

					Order No.		Gold-Palladium	Platin 	Order No.	Quick-No.	Iridium 	Order No.
TM												
Cross, Enduro	250	94 -	B9EG	3530	0,6	B9EGV	5827		BR9EIX		3981	
300 EN	300	03 -	BR8EG	3130	0,5							
Cross, Enduro	300		B9EG	3530	0,6	B9EGV	5827		BR9EIX		3981	
450 EN-F	450	04 -	CR8E	1275	0,7	CR8EVX	6487	226	CR8EIX		4218	
TOKAIDO												
RC 25	25		B5HS	4210	0,8							
TOMOS												
Forza	49		BPR8HS	3725	0,6				BPR8HIX		6742	
Quadro 25	49		B6HS	4510	0,6	B6HVX	7435	203	BR6HIX		3419	
Tomos	50		B7HS	5110	0,5	B7HVX	7836	204	BR7HIX		7067	
Tomos Cross	50		B8HS	5510	0,5	B8HVX	2634	205	BR8HIX		7001	
Tomos	80		B7HS	5110	0,5	B7HVX	7836	204	BR7HIX		7067	
TORPADO												
Derby Automatic	50		B6HS	4510	0,6	B6HVX	7435	203	BR6HIX		3419	
Derby Deluxe	50		B5HS	4210	0,5							
Golf Deluxe	50		B5HS	4210	0,5							
Green	50		B5HS	4210	0,5							
Green Deluxe	50		B5HS	4210	0,5							
Squirrel Cross	50		B7HS	5110	0,5	B7HVX	7836	204	BR7HIX		7067	
TORROT												
Ciclomatic/ 2VL	50		B7HS	5110	0,5	B7HVX	7836	204	BR7HIX		7067	
City CX/N/SL/X	50		B7HS	5110	0,5	B7HVX	7836	204	BR7HIX		7067	
City/L/2V/2V-TT	50		B6HS	4510	0,5	B6HVX	7435	203	BR6HIX		3419	
Cycloscooter S50/HL	50		B6HS	4510	0,5	B6HVX	7435	203	BR6HIX		3419	
Gran Cross, Maxi, Mini	50		B5HS	4210	0,5							
Mustang, Panther, Tiburon	50		B5HS	4210	0,5							
Sport Sachs TX50, TT50	50		B7HS	5110	0,5	B7HVX	7836	204	BR7HIX		7067	
Super Cross/Rally Sachs	50		B7HS	5110	0,5	B7HVX	7836	204	BR7HIX		7067	
Trial, Turismo	50		B5HS	4210	0,5							
TRIUMPH												
Daytona 600	600	03 -	CR9EK	4548	0,7				230	CR9EIX	3521	
Speed Four	600	02 -	CR9EK	4548	0,7				230	CR9EIX	3521	
Speed Triple S	600	02 -	CR9EK	4548	0,7				230	CR9EIX	3521	
Supersport	600	01 -	CR9EK	4548	0,7				230	CR9EIX	3521	
TT 600 (806AD)	600	00 -	CR9EK	4548	0,7				230	CR9EIX	3521	
Bonneville T120, R, V	650		B8ES	2411	0,5	B8EVX	7051	201	BR8EIX		5044	
Daytona 650	650	05 -	CR9EK	4548	0,7				230	CR9EIX	3521	
Tiger, Trophy Sport TR6C	650		B8ES	2411	0,5	B8EVX	7051	201	BR8EIX		5044	
Trophy TR6 —> Nr.029363	650		B7HS	5110	0,5	B7HVX	7836	204	BR7HIX		7067	
Trophy TR6 Nr.029364 —>	650		B7ES	1111	0,5	B7EVX	6934					
Daytona 675	675	06 -	CR9EK	4548	0,7				230	CR9EIX	3521	
Daytona 675 RR	675	06 -	CR9EK	4548	0,7				230	CR9EIX	3521	
Bonneville T140D/E	750		B6ES	7310	0,5	B6EVX	5136					
Bonneville T140V	750		B8ES	2411	0,5	B8EVX	7051	201	BR8EIX		5044	
Daytona 750	750	91 -	DPR8EA-9	4929	0,9	DPR8EVX-9	2872	221	DPR8EIX-9		2202	
Hurricane TRX75	750		B8ES	2411	0,5	B8EVX	7051	201	BR8EIX		5044	
Speed Triple 750	750	97 -	DPR8EA-9	4929	0,9	DPR8EVX-9	2872	221	DPR8EIX-9		2202	

					Order No.		Platin 	Order No.	Quick-No. 	Iridium	Order No.
TRIUMPH											
Sprint RS	750	99 -	DPR8EA-9	4929	0,9	DPR8EVX-9	2872	221	DPR8EIX-9	2202	
Tiger TR7RV, TR7V	750		B8ES	2411	0,5	B8EVX	7051	201	BR8EIX	5044	
Trident T150V, T160	750		B8ES	2411	0,5	B8EVX	7051	201	BR8EIX	5044	
Trident 750	750	91 -	DPR8EA-9	4929	0,9	DPR8EVX-9	2872	221	DPR8EIX-9	2202	
America	790	05 -	DPR8EA-9	4929	0,9	DPR8EVX-9	2872	221	DPR8EIX-9	2202	
Bonneville America(908M)	790	02 -	DPR8EA-9	4929	0,9	DPR8EVX-9	2872	221	DPR8EIX-9	2202	
Bonneville T100	790	02 -	DPR8EA-9	4929	0,9	DPR8EVX-9	2872	221	DPR8EIX-9	2202	
Bonneville (908MD)	790	00 -	DPR8EA-9	4929	0,9	DPR8EVX-9	2872	221	DPR8EIX-9	2202	
Speedmaster	790	02 -	DPR8EA-9	4929	0,9	DPR8EVX-9	2872	221	DPR8EIX-9	2202	
Scrambler 900	865	06 -	DPR8EA-9	4929	0,9	DPR8EVX-9	2872	221	DPR8EIX-9	2202	
Thruxton 900	865	04 -	DPR8EA-9	4929	0,9	DPR8EVX-9	2872	221	DPR8EIX-9	2202	
Adventurer	885	96 -	DPR8EA-9	4929	0,9	DPR8EVX-9	2872	221	DPR8EIX-9	2202	
Daytona 900	885	93 - 96	DPR8EA-9	4929	0,9	DPR8EVX-9	2872	221	DPR8EIX-9	2202	
Legend TT	885	98 -	DPR9EA-9	5329	0,9	DPR9EVX-9	3854	222	DPR9EIX-9	5545	
Daytona Super III	885	94 -	DPR8EA-9	4929	0,9	DPR8EVX-9	2872	221	DPR8EIX-9	2202	
Speed Triple	885	94 - 96	DPR8EA-9	4929	0,9	DPR8EVX-9	2872	221	DPR8EIX-9	2202	
Speed Triple T509	885	97 -	DPR8EA-9	4929	0,9	DPR8EVX-9	2872	221	DPR8EIX-9	2202	
Sport	885	98 -	DPR8EA-9	4929	0,9	DPR8EVX-9	2872	221	DPR8EIX-9	2202	
Sport Sprint 900	885	97 -	DPR8EA-9	4929	0,9	DPR8EVX-9	2872	221	DPR8EIX-9	2202	
Sprint	885	95 -	DPR8EA-9	4929	0,9	DPR8EVX-9	2872	221	DPR8EIX-9	2202	
Sprint 900	885	93 -	DPR8EA-9	4929	0,9	DPR8EVX-9	2872	221	DPR8EIX-9	2202	
Sprint Executive	885	98 -	DPR8EA-9	4929	0,9	DPR8EVX-9	2872	221	DPR8EIX-9	2202	
Sprint ST	885	99 -	DPR8EA-9	4929	0,9	DPR8EVX-9	2872	221	DPR8EIX-9	2202	
Thunderbird (T309RT)	885	95 -	DPR8EA-9	4929	0,9	DPR8EVX-9	2872	221	DPR8EIX-9	2202	
Thunderbird Sport	885	98 - 00	DPR8EA-9	4929	0,9	DPR8EVX-9	2872	221	DPR8EIX-9	2202	
Tiger 900 T400	885	93 - 98	DPR8EA-9	4929	0,9	DPR8EVX-9	2872	221	DPR8EIX-9	2202	
Tiger	885	99 -	DPR8EA-9	4929	0,9	DPR8EVX-9	2872	221	DPR8EIX-9	2202	
Trident 900	885	91 -	DPR8EA-9	4929	0,9	DPR8EVX-9	2872	221	DPR8EIX-9	2202	
Trophy 900	885	96 -	DPR8EA-9	4929	0,9	DPR8EVX-9	2872	221	DPR8EIX-9	2202	
Trophy 900	885	91 - 95	DPR8EA-9	4929	0,9	DPR8EVX-9	2872	221	DPR8EIX-9	2202	
Daytona 955i 72Kw	955	99 - 00	DPR8EA-9	4929	0,9	DPR8EVX-9	2872	221	DPR8EIX-9	2202	
Daytona 955i 94Kw	955	99 - 01	DPR8EA-9	4929	0,9	DPR8EVX-9	2872	221	DPR8EIX-9	2202	
Daytona 955i (595N)	955	02 -	CR9EK	4548	0,6				230	CR9EIX	3521
Daytona Centennial Edition (595N)	955	02 -	CR9EK	4548	0,6				230	CR9EIX	3521
Speed Triple (595N)	955	02 -	CR9EK	4548	0,6				230	CR9EIX	3521
Sprint RS (695AC)	955	02 -	CR9EK	4548	0,6				230	CR9EIX	3521
Sprint ST (695AB)	955	02 -	CR9EK	4548	0,6				230	CR9EIX	3521
Tiger 955i 72Kw (709EN)	955	01 -	DPR8EA-9	4929	0,9	DPR8EVX-9	2872	221	DPR8EIX-9	2202	
Daytona T595	956	97 -	DPR8EA-9	4929	0,9	DPR8EVX-9	2872	221	DPR8EIX-9	2202	
Speed Triple	956	99 - 01	DPR8EA-9	4929	0,9	DPR8EVX-9	2872	221	DPR8EIX-9	2202	
Sprint ST	956	99 - 01	DPR8EA-9	4929	0,9	DPR8EVX-9	2872	221	DPR8EIX-9	2202	
Daytona 1000	1000	91 - 92	DPR8EA-9	4929	0,9	DPR8EVX-9	2872	221	DPR8EIX-9	2202	
Speed Triple 1050	1050	05 -	DPR8EA-9	4929	0,9	DPR8EVX-9	2872	221	DPR8EIX-9	2202	
Sprint ST 1050	1050	05 -	DPR8EA-9	4929	0,9	DPR8EVX-9	2872	221	DPR8EIX-9	2202	
Tiger 1050	1050	06 -	DPR8EA-9	4929	0,9	DPR8EVX-9	2872	221	DPR8EIX-9	2202	
Trophy 1200 (T300E)	1180	96 -	DPR8EA-9	4929	0,9	DPR8EVX-9	2872	221	DPR8EIX-9	2202	
Trophy 1200	1180	91 - 95	DPR8EA-9	4929	0,9	DPR8EVX-9	2872	221	DPR8EIX-9	2202	
Daytona 1200	1200	93 -	DPR8EA-9	4929	0,9	DPR8EVX-9	2872	221	DPR8EIX-9	2202	
Rocket III Twinspark	2300	05.04 -	DPR8EA-9	4929	0,9	DPR8EVX-9	2872	221	DPR8EIX-9	2202	
URAL											
Deco Cruiser	648	98 -	BP4HS	3611	0,6						

					Order No.		Gold-Palladium	Platin 	Order No.	Quick-No.	Iridium		Order No.
URAL													
Italia Cruiser	648	98 -	BP4HS	3611	0,6								
Solo Cruiser	648	98 -	BP4HS	3611	0,6								
Sportsman Classic	648	97 -	BP4HS	3611	0,6								
Tourist Classic	648	97 -	BP4HS	3611	0,6								
IMZ-10	650		BP4HS	3611	0,6								
IMZ-40	650		BP4HS	3611	0,6								
IMZ-50	650		BP4HS	3611	0,6								
Solo Single	650	94 - 96	BP4HS	3611	0,6								
Sportsman	650	94 - 96	BP4HS	3611	0,6								
Tourist Sidecar	650	94 - 96	BP4HS	3611	0,6								
Ural M3-8.103	23,6kW	650	BP5HS	4111	0,5								
Ural M3-8.123	26,5kW	650	BP6ES	7811	0,7	BP6EVX	5832				BPR6EIX	6637	
Tourist	750		B7HS	5110	0,5	B7HVX	7836	204			BR7HIX	7067	
URAL AMERICA													
Bavarian Classic	650	99 -			0,7	BP8HVX	2855						
Deco Classic	650	97 - 98	BP7HS	5111	0,7	BP7HVX	7468				BPR7HIX	5944	
Deco Classic	650	99 -			0,7	BP8HVX	2855						
Deco Cruiser	650	98 -	BP7HS	5111	0,7	BP7HVX	7468				BPR7HIX	5944	
Italia Cruiser	650	94 - 97	BP7HS	5111	0,7	BP7HVX	7468				BPR7HIX	5944	
Italia Cruiser II	650	98 -	BP7HS	5111	0,7	BP7HVX	7468				BPR7HIX	5944	
Patrol Classic	650	99 -			0,7	BP8HVX	2855						
Solo Classic	650	99 -			0,7	BP8HVX	2855						
Solo Cruiser	650	98 -	BP7HS	5111	0,7	BP7HVX	7468				BPR7HIX	5944	
Solo Single	650	94 - 97	BP7HS	5111	0,7	BP7HVX	7468				BPR7HIX	5944	
Sportsman	650	94 - 96	BP7HS	5111	0,7	BP7HVX	7468				BPR7HIX	5944	
Sportsman Classic	650	97 - 98	BP7HS	5111	0,7	BP7HVX	7468				BPR7HIX	5944	
Tourist Classic	650	97 - 98	BP7HS	5111	0,7	BP7HVX	7468				BPR7HIX	5944	
Tourist Classic	650	99 -			0,7	BP8HVX	2855						
Tourist Sidecar	650	94 - 97	BP7HS	5111	0,7	BP7HVX	7468				BPR7HIX	5944	
VALENTI													
CR 80W Cross (Yamaha/Valent)	80				0,5	B10EGV	5927						
VELOSOLEX													
2200	50		B4H	4110	0,5								
3300 /3800	50		B4H	4110	0,5								
5000	50		B4H	4110	0,5								
6000	50		B4H	4110	0,5								
8000 / 8000 GS Ténor	50		B6HS	4510	0,6	B6HVX	7435	203			BR6HIX	3419	
GL Ténor	50		B6HS	4510	0,6	B6HVX	7435	203			BR6HIX	3419	
GR Ténor	50		B6HS	4510	0,6	B6HVX	7435	203			BR6HIX	3419	
L / R / S Ténor	50		B6ES	7310	0,7	B6EVX	5136						
Micron	50		B4H	4110	0,5								
Pli-solex	50		B4H	4110	0,5								
VERTEMATI													
E 450 E	503		CR9EK	4548	0,7					230	CR9EIX	3521	
E 450	503		CR9EK	4548	0,7					230	CR9EIX	3521	
E 501	503		CR9EK	4548	0,7					230	CR9EIX	3521	
E 501 E	503		CR9EK	4548	0,7					230	CR9EIX	3521	
E 570	503		CR9EK	4548	0,7					230	CR9EIX	3521	



Order No.



Gold-Palladium



Order No.



Quick-No.



Order No.

VERTEMATI

E 570 E	503		CR9EK	4548	0,7			230	CR9EIX	3521
---------	-----	--	-------	------	-----	--	--	-----	--------	------

VOR

EN Enduro	400	00 -	CR8EK	3478	0,6				CR8EIX	4218
ENE	400	04 -	CR8EK	3478	0,6				CR8EIX	4218
EN-MAR	400	04 -	CR8EK	3478	0,6				CR8EIX	4218
MX Cross	400	00 -	CR8EK	3478	0,6				CR8EIX	4218
SM Super Moto	400	00 -	CR8EK	3478	0,6				CR8EIX	4218
SM Super Moto Competition	400	00 -	CR8EK	3478	0,6				CR8EIX	4218
EN Enduro	503	99 -	CR8EK	3478	0,6				CR8EIX	4218
MX Cross	503	99 -	CR8EK	3478	0,6				CR8EIX	4218
SM Super Moto	503	99 -	CR8EK	3478	0,6				CR8EIX	4218
SM Super Moto Competition	503	99 -	CR8EK	3478	0,6				CR8EIX	4218
ENE	530	04 -	CR8EK	3478	0,6				CR8EIX	4218
EN-MAR	530	04 -	CR8EK	3478	0,6				CR8EIX	4218
Super Motard Com.	530	00 -	CR8EK	3478	0,6				CR8EIX	4218

YAMAHA

Golf Car G2A/G9A		92 -	B5ES	6410	0,7						
CA 50 (14T)	50	83 - 87	BPR6HS	7022	0,7	BPR6HVX	2740	214	BPR6HIX	4085	
CE 50 E	50		BP6HS-10	6326	1,0						
CH 50	50		BPR7HS	6422	0,7	BPR7HVX	2938	215	BPR7HIX	5944	
CR 50 Z/SS	50	93 -	BP7HS-10	7829	1,0						
CV 50	50		BPR6HS	7022	0,7	BPR6HVX	2740	214	BPR6HIX	4085	
CW 50	50	91 - 93	BR7HS	4122	0,8			211	BR7HIX	7067	
CW 50 (4BX)	50	94 -	BPR7HS	6422	0,7	BPR7HVX	2938	215	BPR7HIX	5944	
CY 50	50	94 -	BP7HS	5111	0,7	BP7HVX	7468		BPR7HIX	5944	
CY 50 E	50	93 -	BP7HS	5111	0,7	BP7HVX	7468		BPR7HIX	5944	
CY 50 F	50	94 -	BPR7HS	6422	0,7	BPR7HVX	2938	215	BPR7HIX	5944	
DT 50	50		B7HS	5110	0,8	B7HVX	7836	204	BR7HIX	7067	
DT 50 / supermotard	50	03 -	BR9ES	5722	0,8	BR9EVX	1265	208	BR9EIX	3981	
DT 50 A (F)	50		BR6HS	3922	0,7				209	BR6HIX	3419
DT 50 E	50	93 -	BR8ES	5422	0,7	BR8EVX	1262	207	BR8EIX	5044	
DT 50 F	50	94 -	BR8ES	5422	0,8	BR8EVX	1262	207	BR8EIX	5044	
DT 50 LC (3UN3/4/5/6/7)	50	93 -	BR8ES	5422	0,7	BR8EVX	1262	207	BR8EIX	5044	
DT 50 M (2M4)	50	78 - 81	B6HS	4510	0,7	B6HVX	7435	203	BR6HIX	3419	
DT 50 M (D)	50	86 -	BR7HS	4122	0,7				211	BR7HIX	7067
DT 50 M (NL)	50	86 -	B6HS	4510	0,7	B6HVX	7435	203	BR6HIX	3419	
DT 50 M (S)	50	86 -	BR6HS	3922	0,7				209	BR6HIX	3419
DT 50 M (A) (B)	50	86 -	B8HS	5510	0,7	B8HVX	2634	205	BR8HIX	7001	
DT 50 MX (1NN)	50	01.86 - 12.89	BR6HS	3922	0,7				209	BR6HIX	3419
DT 50 MX (4ET1)	50	92 -	B6HS	4510	0,7	B6HVX	7435	203	BR6HIX	3419	
DT 50 MX (3TG2)	50	92 -	BR6HS	3922	0,7				209	BR6HIX	3419
DT 50 MX (4ER1)	50	92 -	BR7HS	4122	0,7				211	BR7HIX	7067
DT 50 R (3MN2)(3MN3)(3HL3)											
(4CT2)(4CT4)(4CT6)	50	91 -	BR7HS	4122	0,7				211	BR7HIX	7067
DT 50 R (5BK1)(5BL1)	50	97 -	BR8ES	5422	0,8	BR8EVX	1262	207	BR8EIX	5044	
DT 50 R (3MP2)(3MS2)(3MR2)(4AD2)(4JU1)	50	91 -	BR6HS	3922	0,7				209	BR6HIX	3419
DT 50 R (5EC1)(5VB2)(5BK4)(5BK3)(5VB1)	50	97 -	CR8E	1275	0,7	CR8EVX	6487	226	CR8EIX	4218	
DX 50 (5BK2)	50	97 -	BR8ES	5422	0,8	BR8EVX	1262	207	BR8EIX	5044	
DX 50 S (4CT3)(4CT5)(4CT7)	50	92 -	BR7HS	4122	0,7				211	BR7HIX	7067
ES 50	50		B8HS	5510	0,7	B8HVX	2634	205	BR8HIX	7001	



Order No.



Gold-Palladium



Platin

Order No.

Quick-No.







Iridium



Order No.

YAMAHA

Fizz (4RC)	50	95 -	BR8HS	4322	0,7	BR8HVX	6265	212	BR8HIX	7001
FS 1 DX (3F2)	50	79 - 80	BR6HS	3922	0,7			209	BR6HIX	3419
FS 1 E	50		B7HS	5110	0,6	B7HVX	7836	204	BR7HIX	7067
FS 3 M	50		B8HS	5510	0,7	B8HVX	2634	205	BR8HIX	7001
GT 50 B	50		B7HS	5110	0,7	B7HVX	7836	204	BR7HIX	7067
GT 50 D (FT1)	50	73 - 75	B7HS	5110	0,7	B7HVX	7836	204	BR7HIX	7067
Jog 50	50	90 -	BPR6HS	7022	0,7	BPR6HVX	2740	214	BPR6HIX	4085
LB 2	50		B7HS	5110	0,7	B7HVX	7836	204	BR7HIX	7067
LB 2 80	50	81 -	BP6HS	4511	0,7	BP6HVX	4635		BPR6HIX	4085
LB 2 80	50	- 80	B6HS	4510	0,7	B6HVX	7435	203	BR6HIX	3419
LB 2 M	50	81 -	BP6HS	4511	0,7	BP6HVX	4635		BPR6HIX	4085
LB 2 M (551)	50	75 - 80	B6HS	4510	0,7	B6HVX	7435	203	BR6HIX	3419
LB 3 80	50		B6HS	4510	0,7	B6HVX	7435	203	BR6HIX	3419
LB 3 M	50		BP6HS	4511	0,7	BP6HVX	4635		BPR6HIX	4085
LC 50	50		BP4HS	3611	0,7					
LC 50 H	50		BP4HS	3611	0,7					
LC 50 M	50		BP4HS	3611	0,7					
MA 50	50		BP4HS	3611	0,7					
MA 50 M	50		BP4HS	3611	0,7					
MBK Magnum	50	90 -	B8ES	2411	0,6	B8EVX	7051	201	BR8EIX	5044
MR 50	50		B7HS	5110	0,7	B7HVX	7836	204	BR7HIX	7067
MR 50 H	50		B7HS	5110	0,7	B7HVX	7836	204	BR7HIX	7067
PW 50 (3PT)	50	01.87 -	BP4HS	3611	0,6					
PW 50 E	50	93 -	BPR4HS	7823	0,8					
PW 50 H / F	50		BP4HS	3611	0,7					
QT 50	50		BP4HS	3611	0,7					
QT 50 H	50		BP4HS	3611	0,7					
RD 50 DX (353)	50	73 - 75	B8HS	5510	0,7	B8HVX	2634	205	BR8HIX	7001
RD 50 H	50		B7HS	5110	0,7	B7HVX	7836	204	BR7HIX	7067
RD 50 MX (2E0)	50	77 - 81	B6HS	4510	0,7	B6HVX	7435	203	BR6HIX	3419
SA 50	50		BP4HS	3611	0,7					
SA 50 H	50		BP4HS	3611	0,7					
SA 50 M	50		BP4HS	3611	0,7					
SG 50 (34N)	50	84 - 85	BPR6HS	7022	0,7	BPR6HVX	2740	214	BPR6HIX	4085
SH 50 / F	50		BPR6HS-10	2633	1,0					
SH 50 E / ED / MF	50	93 -	BP6HS-10	6326	1,0					
T 50	50		C6HSA	3228	0,7				CR6HIX	7274
TY 50 M (1G3)	50	77 - 80	B6HS	4510	0,7	B6HVX	7435	203	BR6HIX	3419
TZR 50	50	03 -	BR9ES	5722	0,8	BR9EVX	1265	208	BR9EIX	3981
V 50	50		B6HS	4510	0,6	B6HVX	7435	203	BR6HIX	3419
V 50 D	50	93 -	B7HS	5110	0,7	B7HVX	7836	204	BR7HIX	7067
V 50 E	50		B7HS	5110	0,7	B7HVX	7836	204	BR7HIX	7067
V 50 M	50	81 - 83	BP6HS	4511	0,7	BP6HVX	4635		BPR6HIX	4085
V 50 M	50	- 80	B6HS	4510	0,7	B6HVX	7435	203	BR6HIX	3419
V 50 M	50	84 -	BR6ES	4922	0,8					
YA 50 (5AK)	50	97 -	BR7HS	4122	0,7			211	BR7HIX	7067
YB 50 S	50		B7HS	5110	0,7	B7HVX	7836	204	BR7HIX	7067
YE 50	50	93 -	BR7HS	4122	0,7			211	BR7HIX	7067
YZ 50	50		B9ES	2611	0,8	B9EVX	7254	202	BR9EIX	3981
YZ 50 H	50		B9ES	2611	0,8	B9EVX	7254	202	BR9EIX	3981
RD 60 B	60		B7HS	5110	0,7	B7HVX	7836	204	BR7HIX	7067
YB 60	60		B7HS	5110	0,7	B7HVX	7836	204	BR7HIX	7067

					Order No.		Platin 	Order No.	Quick-No. 	Iridium	Order No.
YAMAHA											
YZ 60 H		60		B8ES	2411	0,8	B8EVX	7051	201	BR8EIX	5044
CW 65		65	94 -	BR7HS	4122	0,7			211	BR7HIX	7067
Active 80		80	90 -	BPR7HS	6422	0,7	BPR7HVX	2938	215	BPR7HIX	5944
CH 80		80		BR7HS	4122	0,7			211	BR7HIX	7067
CV 80		80		BPR7HS	6422	0,7	BPR7HVX	2938	215	BPR7HIX	5944
DT 80 LC-I (37A)		80	83 - 86	BR8ES	5422	0,8	BR8EVX	1262	207	BR8EIX	5044
DT 80 LC-II (53V)		80	84 -	BR9ES	5722	0,8	BR9EVX	1265	208	BR9EIX	3981
DT 80 MX (5J1)		80	81 - 84	B8HS	5510	0,7	B8HVX	2634	205	BR8HIX	7001
DT 80 MX-S (5T8)		80	83 - 86	BR8HS	4322	0,7	BR8HVX	6265	212	BR8HIX	7001
FS 80		80		B7HS	5110	0,7	B7HVX	7836	204	BR7HIX	7067
FS 80 SE (5A7)		80	81 - 82	B7HS	5110	0,7	B7HVX	7836	204	BR7HIX	7067
GT 80 (477)		80	74 - 75	B7HS	5110	0,7	B7HVX	7836	204	BR7HIX	7067
GT 80 D		80		B7HS	5110	0,7	B7HVX	7836	204	BR7HIX	7067
GT 80 E		80		B7HS	5110	0,7	B7HVX	7836	204	BR7HIX	7067
LB 80		80		BP6HS	4511	0,7	BP6HVX	4635		BP6HIX	4085
LB 80 2A		80		B6HS	4510	0,7	B6HVX	7435	203	BR6HIX	3419
LB 80 2AC		80		B6HS	4510	0,7	B6HVX	7435	203	BR6HIX	3419
LB 80 2AD		80		B6HS	4510	0,7	B6HVX	7435	203	BR6HIX	3419
LB 80 2H		80		B6HS	4510	0,7	B6HVX	7435	203	BR6HIX	3419
LB 80 2HD		80		B7HS	5110	0,7	B7HVX	7836	204	BR7HIX	7067
LB 80 3 (1M9)		80	78 - 79	B6HS	4510	0,7	B6HVX	7435	203	BR6HIX	3419
LB 80 3D		80		B6HS	4510	0,7	B6HVX	7435	203	BR6HIX	3419
MX 80		80		B7HS	5110	0,7	B7HVX	7836	204	BR7HIX	7067
MX 80 H		80		B7HS	5110	0,7	B7HVX	7836	204	BR7HIX	7067
PW 80 (21W)		80	83 - 90	BPR6HS	7022	0,7	BPR6HVX	2740	214	BPR6HIX	4085
PW 80 E / F (4BC..)		80	93 -	BP6HS	4511	0,7	BP6HVX	4635		BPR6HIX	4085
RD 80 LC-II (30W)		80	83 - 87	BR8ES	5422	0,8	BR8EVX	1262	207	BR8EIX	5044
RD 80 MX (5G1)		80	81 - 82	B8HS	5510	0,7	B8HVX	2634	205	BR8HIX	7001
RX 80 SE (12N)		80	82 - 83	B8HS	5510	0,7	B8HVX	2634	205	BR8HIX	7001
T 80		80		CR7HS	7223	0,7				CR7HIX	7544
TY 80		80		B7HS	5110	0,7	B7HVX	7836	204	BR7HIX	7067
V 80		80		BP6HS	4511	0,7	BP6HVX	4635		BPR6HIX	4085
V 80 H / D		80		BP6HS	4511	0,7	BP6HVX	4635		BPR6HIX	4085
Y 80		80		BP6HS	4511	0,7	BP6HVX	4635		BPR6HIX	4085
Y 80 E		80		BP6HS	4511	0,7	BP6HVX	4635		BPR6HIX	4085
YB 80		80		B7HS	5110	0,7	B7HVX	7836	204	BR7HIX	7067
YE 80 (4MU)		80	94 -	BR7HS	4122	0,7			211	BR7HIX	7067
YZ 80		80	84 - 85	B9EG	3530	0,6	B9EGV	5827		BR9EIX	3981
YZ 80 (4GT)		80	95 -	B10EG	3630	0,7	B10EGV	5927			
YZ 80 (1LR)		80	86 -	BR9EG	3230	0,6	BR9EVX	1265		BR9EIX	3981
YZ 80 B		80		B8HS	5510	0,7	B8HVX	2634	205	BR8HIX	7001
YZ 80 C		80		B8ES	2411	0,8	B8EVX	7051	201	BR8EIX	5044
YZ 80 D		80		B8ES	2411	0,8	B8EVX	7051	201	BR8EIX	5044
YZ 80 E		80	- 92	B8ES	2411	0,8	B8EVX	7051	201	BR8EIX	5044
YZ 80 E / F/LW/(4LB)/ LWF		80	93 -	B10EG	3630	0,6	B10EGV	5927			
YZ 80 H		80	- 83	B8ES	2411	0,8	B8EVX	7051	201	BR8EIX	5044
YZ 80 H.R.		80		B7HS	5110	0,7	B7HVX	7836	204	BR7HIX	7067
YZ 80 L.R.		80		B8ES	2411	0,8	B8EVX	7051	201	BR8EIX	5044
YA 90 E / F		90	93 -	BR7HS	4122	0,7			211	BR7HIX	7067
AG 100		100		B7HS	5110	0,7	B7HVX	7836	204	BR7HIX	7067
AG 100 H / E / F		100		B7ES	1111	0,8	B7EVX	6934			
DT 100		100		B7ES	1111	0,8	B7EVX	6934			



Order No.



Gold-Palladium



Platin

Order No.

Quick-No.

Iridium



Order No.

YAMAHA

DT 100 B	100		B8HS	5510	0,7	B8HVX	2634	205	BR8HIX	7001
DT 100 C	100		B7ES	1111	0,8	B7EVX	6934			
DT 100 D	100		B8ES	2411	0,8	B8EVX	7051	201	BR8EIX	5044
DT 100 E	100		B8ES	2411	0,8	B8EVX	7051	201	BR8EIX	5044
DT 100 H	100		B8ES	2411	0,8	B8EVX	7051	201	BR8EIX	5044
DT 100 SD	100		B8ES	2411	0,8	B8EVX	7051	201	BR8EIX	5044
DT 100 X	100		B7ES	1111	0,8	B7EVX	6934			
DX 100	100		B7HS	5110	0,7	B7HVX	7836	204	BR7HIX	7067
DX 100 H	100		B7HS	5110	0,7	B7HVX	7836	204	BR7HIX	7067
MX 100	100	79 -	B7ES	1111	0,8	B7EVX	6934			
MX 100 B	100				0,6	B8EVX	7051		BR8EIX	5044
MX 100 H	100		B7ES	1111	0,8	B7EVX	6934			
RS 100 B	100		B8HS	5510	0,7	B8HVX	2634	205	BR8HIX	7001
RS 100 DX (1Y8)	100	76 - 81	B8HS	5510	0,7	B8HVX	2634	205	BR8HIX	7001
RS 100 P	100		BP6HS	4511	0,7	BP6HVX	4635		BPR6HIX	4085
RS 100 S	100		B8HS	5510	0,7	B8HVX	2634	205	BR8HIX	7001
RS 100 X	100		B8HS	5510	0,7	B8HVX	2634	205	BR8HIX	7001
RT 100 E / F	100	93 -	B7ES	1111	0,8	B7EVX	6934			
RX 100 12,7mm	100		B8HS	5510	0,7	B8HVX	2634	205	BR8HIX	7001
RX 100 19,0mm	100		B8ES	2411	0,8	B8EVX	7051	201	BR8EIX	5044
RXS 100	100		BR8HS	4322	0,7	BR8HVX	6265	212	BR8HIX	7001
RX-ZD	100	93 -	BP8ES	2912	0,8	BP8EVX	2671			
V 100/E/S/SH	100	93 -	BP7HS-10	7829	1,0					
YB 100	100	94 -	BP6HS	4511	0,7	BP6HVX	4635		BPR6HIX	4085
YB 100 M	100		B8HS	5510	0,7	B8HVX	2634	205	BR8HIX	7001
YB 100 P	100		B7HS	5110	0,7	B7HVX	7836	204	BR7HIX	7067
YZ 100	100	- 83	B10EG	3630	0,6	B10EGV	5927			
YZ 100 E	100		B10EG	3630	0,6	B10EGV	5927			
YZ 100 H	100		B10EG	3630	0,6	B10EGV	5927			
V 110 E	110	93 -	BP7HS-10	7829	1,0					
RX 115	115	93 -	BP8HS	2630	0,7				BPR8HIX	6742
V 120 JR / ZR	120	94 -	BP8ES	2912	0,8	BP8EVX	2671			
BL 125 (50W)	125	85 - 89	BPR8HS	3725	0,7				BPR8HIX	6742
DT 125	125	94 -	B8ES	2411	0,8	B8EVX	7051	201	BR8EIX	5044
DT 125 RE	125	04 -	BR8ES	5422	0,8	BR8EVX	1262	207	BR8EIX	5044
DT 125 E (1G0)	125	77 - 79	BR9ES	5722	0,8	BR9EVX	1265	208	BR9EIX	3981
DT 125 E (AT2)	125	73 - 76	B8ES	2411	0,8	B8EVX	7051	201	BR8EIX	5044
DT 125 ED	125		B8ES	2411	0,8	B8EVX	7051	201	BR8EIX	5044
DT 125 F	125		B8ES	2411	0,8	B8EVX	7051	201	BR8EIX	5044
DT 125 H	125		B8ES	2411	0,8	B8EVX	7051	201	BR8EIX	5044
DT 125 LC	125	86 -	BR9ES	5722	0,8	BR9EVX	1265	208	BR9EIX	3981
DT 125 LC (10V)	125	82 - 85	BR8ES	5422	0,8	BR8EVX	1262	207	BR8EIX	5044
DT 125 MX	125		B8ES	2411	0,8	B8EVX	7051	201	BR8EIX	5044
DT 125 R (4BL) / RE (3RM)	125	91 -	BR9ES	5722	0,8	BR9EVX	1265	208	BR9EIX	3981
DT 125 Tenere (I)	125		B9ES	2611	0,8	B9EVX	7254	202	BR9EIX	3981
DT 125 X	125	05 -	BR8ES	5422	0,5	BR8EVX	1262	207	BR8EIX	5044
IT 125	125		B9EG	3530	0,6	B9EGV	5827		BR9EIX	3981
IT 125 H	125		B9EG	3530	0,6	B9EGV	5827		BR9EIX	3981
MX 125	125				0,6	B9EVX	7254		BR9EIX	3981
R 125 SE	125		BP7HS	5111	0,7	BP7HVX	7468		BPR7HIX	5944
RD 125 12,7mm	125		B8HS	5510	0,7	B8HVX	2634	205	BR8HIX	7001
RD 125 19,0mm	125		B8ES	2411	0,8	B8EVX	7051	201	BR8EIX	5044



Order No.



Gold-Palladium



Order No.

Quick-No.

Iridium



Order No.

YAMAHA

RD 125 C	125		B8ES	2411	0,8	B8EVX	7051	201	BR8EIX	5044
RD 125 C-DX	125		B8ES	2411	0,8	B8EVX	7051	201	BR8EIX	5044
RD 125 D	125		B8ES	2411	0,8	B8EVX	7051	201	BR8EIX	5044
RD 125 D-DX (AS3)	125	73 - 75	B8HS	5510	0,7	B8HVX	2634	205	BR8HIX	7001
RD 125 LC	125	84 -	BR8ES	5422	0,8	BR8EVX	1262	207	BR8EIX	5044
RD 125 LC (10W)	125	82 - 83	BR9ES	5722	0,8	BR9EVX	1265	208	BR9EIX	3981
RS 125 DX	125		B8HS	5510	0,7	B8HVX	2634	205	BR8HIX	7001
RS 125 E	125		B7HS	5110	0,7	B7HVX	7836	204	BR7HIX	7067
RS 125 P	125		BP7HS	5111	0,7	BP7HVX	7468		BPR7HIX	5944
RS 125 Z	125		B8HS	5510	0,7	B8HVX	2634	205	BR8HIX	7001
RX 125 12,7mm	125		B8HS	5510	0,7	B8HVX	2634	205	BR8HIX	7001
RX 125 19,0mm	125		B8ES	2411	0,8	B8EVX	7051	201	BR8EIX	5044
RX 125 H	125		B7HS	5110	0,7	B7HVX	7836	204	BR7HIX	7067
SR 125	125		D8EA	2120	0,7	D8EVX	2850	216	DR8EIX	6681
SR 125 (10F)	125	97 -	DR8EA	7162	0,7	DR8EVX	6354		DR8EIX	6681
SR 125 Z	125	93 -	DR8EA	7162	0,7	DR8EVX	6354		DR8EIX	6681
TA 125 (400)	125	73 - 75	B10EG	3630	0,6	B10EGV	5927			
TA 125 A	125		B10EG	3630	0,6	B10EGV	5927			
TDR 125 (4GW)	125	92 -	BR9ES	5722	0,9	BR9EVX	1265	208	BR9EIX	3981
TDR 125 (5AN)	125	97 -	BR8ES	5422	0,8	BR8EVX	1262	207	BR8EIX	5044
TW 125 (DE011/012)	125	99 -	DR8EA	7162	0,6	DR8EVX	6354		DR8EIX	6681
TY 125 (1K6)	125	77 - 81	B7ES	1111	0,7	B7EVX	6934			
TZ 125 (4JT)	125	95 -	R7376-10	4457	0,6					
TZ 125 (3V3)	125	80 -			0,6	B10EVX	7335		BR10EIX	6801
TZ 125 / F	125	94 -	R7376-10	4457	0,6					
TZ 125 H	125				0,6	B10EVX	7335		BR10EIX	6801
TZR 125	125	- 92	BR9ES	5722	0,8	BR9EVX	1265	208	BR9EIX	3981
TZR 125	125	93 -	BR9ECM	3252	0,8	BR9ECMVX	2434			
XT 125	125		D8EA	2120	0,7	D8EVX	2850	216	DR8EIX	6681
XT 125 R	125	05 -	CR7HSA	4549	0,8				CR7HIX	7544
XT 125 X	125	05 -	CR7HSA	4549	0,8				CR7HIX	7544
XV 125 (5AJ)	125	97 -	CR6HSA	2983	0,6				CR6HIX	7274
XV 125 S Virago(5AJ)	125	99 -	CR6HSA	2983	0,6				CR6HIX	7274
XVS 125 (VP05)	125	00 -	CR7HSA	4549	0,6				CR7HIX	7544
YB 125	125		B7HS	5110	0,7	B7HVX	7836	204	BR7HIX	7067
YBR 125	125	05 -	CR6HSA	2983	0,7				CR6HIX	7274
YS 125	125				0,6	B9EVX	7254		BR9EIX	3981
YZ 125	125		B9EG	3530	0,6	B9EGV	5827		BR9EIX	3981
YZ 125 B	125		B9EG	3530	0,6	B9EGV	5827		BR9EIX	3981
YZ 125 C	125		B9EG	3530	0,6	B9EGV	5827		BR9EIX	3981
YZ 125 E	125		B9EG	3530	0,6	B9EGV	5827		BR9EIX	3981
YZ 125 E / E1 / F	125	93 -	BR9EG	3230	0,6	BR9EVX	1265		BR9EIX	3981
YZ 125 H	125		B9EG	3530	0,6	B9EGV	5827		BR9EIX	3981
YZ 125 X	125		B9EG	3530	0,6	B9EGV	5827		BR9EIX	3981
FZ 150	150	94 -	C7HSA	4629	0,7	C7HVX	4533		CR7HIX	7544
FZR 150	150	94 -	C7HSA	4629	0,7	C7HVX	4533		CR7HIX	7544
RX 150	150	93 -	BP8ES	2912	0,8	BP8EVX	2671			
SR 150	150	93 -	D8EA	2120	0,7	D8EVX	2850	216	DR8EIX	6681
DT 165 R	165	91 -	BR8ES	5422	0,8	BR8EVX	1262	207	BR8EIX	5044
AG 175	175		B8ES	2411	0,8	B8EVX	7051	201	BR8EIX	5044
AG 175 H	175		B7ES	1111	0,8	B7EVX	6934			
DT 175 (CT1)	175	74 - 75	B8ES	2411	0,8	B8EVX	7051	201	BR8EIX	5044



Order No.



Gold-Palladium



Order No.

Quick-No.

Iridium



Order No.

YAMAHA

DT 175 E / F	175		B8ES	2411	0,8	B8EVX	7051	201	BR8EIX	5044
DT 175 H	175		B9ES	2611	0,8	B9EVX	7254	202	BR9EIX	3981
DT 175 MX (2K4)	175	09.78 - 12.81	B8ES	2411	0,8	B8EVX	7051	201	BR8EIX	5044
IT 175 (5Y0)	175	83 - 84	B9EG	3530	0,6	B9EGV	5827		BR9EIX	3981
IT 175 E	175				0,6	B10EVX	7335		BR10EIX	6801
IT 175 H	175		B9EG	3530	0,6	B9EGV	5827		BR9EIX	3981
MX 175	175		B8ES	2411	0,8	B8EVX	7051	201	BR8EIX	5044
MX 175 B	175				0,6	B8EVX	7051		BR8EIX	5044
MX 175 H	175		B8ES	2411	0,8	B8EVX	7051	201	BR8EIX	5044
TY 175	175		B7ES	1111	0,8	B7EVX	6934			
TY 175 E	175		B7ES	1111	0,8	B7EVX	6934			
TY 175 J	175		B7ES	1111	0,8	B7EVX	6934			
YZ 175	175				0,6	B10EVX	7335		BR10EIX	6801
RT 180 E	180	93 -	B8ES	2411	0,8	B8EVX	7051	201	BR8EIX	5044
XC 180 (32H)	180	83 - 84	DPR8EA-9	4929	0,9	DPR8EVX-9	2872	221	DPR8EIX-9	2202
SH 185 H	185		D7EA	7912	0,7	D7EVX	2734			
RS 195	195		B7ES	1111	0,8	B7EVX	6934			
AG 200 E / F	200	93 -	D8EA	2120	0,7	D8EVX	2850	216	DR8EIX	6681
BW 200	200		D8EA	2120	0,7	D8EVX	2850	216	DR8EIX	6681
DT 200 LC / RE / RF	200	93 -	BR9ES	5722	0,8	BR9EVX	1265	208	BR9EIX	3981
DT 200 R	200		BR9ES	5722	0,8	BR9EVX	1265	208	BR9EIX	3981
IT 200 S	200		BR9EG	3230	0,6	BR9EVX	1265		BR9EIX	3981
NR 200	200		B7ES	1111	0,8	B7EVX	6934			
RD 200 12,7mm	200		B7HS	5110	0,7	B7HVX	7836			
RD 200 19,0mm (397)	200		B7ES	1111	0,7	B7EVX	6934	204	BR7HIX	7067
RD 200 C	200		B8ES	2411	0,8	B8EVX	7051	201	BR8EIX	5044
RD 200 C-DX	200		B8ES	2411	0,8	B8EVX	7051	201	BR8EIX	5044
RD 200 D	200		B8ES	2411	0,8	B8EVX	7051	201	BR8EIX	5044
RD 200 D-DX (1E8)	200	77 - 80	B8ES	2411	0,8	B8EVX	7051	201	BR8EIX	5044
RS 200	200		B8ES	2411	0,8	B8EVX	7051	201	BR8EIX	5044
TW 200	200	01.87 -	DR8EA	7162	0,7	DR8EVX	6354		DR8EIX	6681
TW 200 E / EC / F	200	93 -	DR8EA	7162	0,7	DR8EVX	6354		DR8EIX	6681
TW 200 FC	200	94 -	D8EA	2120	0,7	D8EVX	2850	216	DR8EIX	6681
WR 200 R / RE / RF	200	93 -	BR9ES	5722	0,8	BR9EVX	1265	208	BR9EIX	3981
XT 225 E / EC / F / FC	225	93 -	DR8EA	7162	0,7	DR8EVX	6354		DR8EIX	6681
TDR 240	240		BR9ES	5722	0,8	BR9EVX	1265	208	BR9EIX	3981
XV 240	240		CR6HS	7023	0,7			223	CR6HIX	7274
DT 250 (512)	250	75 - 76	B8ES	2411	0,8	B8EVX	7051	201	BR8EIX	5044
DT 250 E	250		B8ES	2411	0,8	B8EVX	7051	201	BR8EIX	5044
DT 250 H	250		B8ES	2411	0,8	B8EVX	7051	201	BR8EIX	5044
DT 250 MX (1R7)	250	77 - 81	B8ES	2411	0,8	B8EVX	7051	201	BR8EIX	5044
IT 250 (45J)	250	85 -	B9EG	3530	0,6	B9EGV	5827		BR9EIX	3981
IT 250 (4V5)	250	81 -	B8EG	3430	0,6	B8EGV	5627			
IT 250 J	250		B9EG	3530	0,6	B9EGV	5827		BR9EIX	3981
IT 250 K	250		B9EG	3530	0,6	B9EGV	5827		BR9EIX	3981
IT 250 N	250		BR9EG	3230	0,6	BR9EVX	1265		BR9EIX	3981
MX 250	250				0,6	B8EVX	7051		BR8EIX	5044
R1-Z	250	93 -	BR9ES	5722	0,8	BR9EVX	1265	208	BR9EIX	3981
RD 250 (522)	250	75 -	B8ES	2411	0,8	B8EVX	7051	201	BR8EIX	5044
RD 250 D	250		B8ES	2411	0,8	B8EVX	7051	201	BR8EIX	5044
RD 250 LC (4L1)	250	80 - 83	B8ES	2411	0,8	B8EVX	7051	201	BR8EIX	5044
SE 250 (I)	250		BPR7ES	2023	0,8	BPR7EVX	5565		BPR7EIX	4055



Order No.



Gold-Palladium



Platinum

Order No.

Quick-No.



Iridium

Order No.

YAMAHA

SR 250 (I)	250			BPR7ES	2023	0,8	BPR7EVX	5565			BPR7EIX	4055
SR 250 H / F	250			BP7ES	2412	0,8	BP7EVX	7270	206		BPR7EIX	4055
SR 250 SE (3Y8)	250	80 -	82	BP7ES	2412	0,8	BP7EVX	7270	206		BPR7EIX	4055
SR 250 TH	250			BP7ES	2412	0,8	BP7EVX	7270	206		BPR7EIX	4055
TDR 250 (3CK)	250	88 -	89	BR9ES	5722	0,8	BR9EVX	1265	208		BR9EIX	3981
TRD 250 (I)	250			BR9ES	5722	0,7	BR9EVX	1265	208		BR9EIX	3981
Tricker XG 250	250	05 -		DR7EA	7839	0,7						
TT 250	250			D8EA	2120	0,7	D8EVX	2850	216		DR8EIX	6681
TT 250 R / RF	250	94 -		CR9E	6263	0,7	CR9EVX	5943	227		CR9EIX	3521
TY 250 (38V)	250	84 -	87	BR6ES	4922	0,8						
TY 250 (3BA)	250	88 -	90	B7ES	1111	0,8	B7EVX	6934				
TY 250 (S16)	250	75 -	79	B7ES	1111	0,8	B7EVX	6934				
TY 250 Z (4GG)	250	94 -	96			0,6	BP6EVX	5832			BPR6EIX	6637
TZ 250	250	84 -		B10EG	3630	0,5	B10EGV	5927				
TZ 250	250	-	83			0,6	B10EVX	7335			BR10EIX	6801
TZ 250 (4DP)	250	95 -		R6179A-105P	2697	0,6						
TZ 250 / F	250	94 -		R6179A-105P	2697	0,6						
TZ 250 E	250	-	83			0,6	B10EVX	7335			BR10EIX	6801
TZ 250 E/E1	250	93 -		R5184-105	3334	0,6						
TZ 250 H	250	-	83			0,6	B10EVX	7335			BR10EIX	6801
TZR 250 " V2"	250	91 -	95	BR9ECM	3252	0,6	BR9ECMVX	2434				
TZR 250 (2MA)	250	87 -	89	BR9ES	5722	0,8	BR9EVX	1265	208		BR9EIX	3981
TZR 250R/RS/RSP	250	93 -		BR9ECM	3252	0,8	BR9ECMVX	2434				
WR 250 F	250	03 -		CR8E	1275	0,7	CR8EVX	6487	226		CR8EIX	4218
WR 250 F	250	01 -		CR8E	1275	0,7	CR8EVX	6487	226		CR8EIX	4218
WR 250 Z / ZE / ZF (4JW)	250	93 -		B8EG	3430	0,6	B8EGV	5627				
XS 250 (1V5)	250	78 -	79	BP7ES	2412	0,8	BP7EVX	7270	206		BPR7EIX	4055
XS 250 C	250			BP7ES	2412	0,8	BP7EVX	7270	206		BPR7EIX	4055
XS 250 H	250			BP7ES	2412	0,8	BP7EVX	7270	206		BPR7EIX	4055
XS 250 RH	250	-	83	BP7ES	2412	0,8	BP7EVX	7270	206		BPR7EIX	4055
XS 250 SE	250			BP7ES	2412	0,8	BP7EVX	7270	206		BPR7EIX	4055
XS 250 SH	250			BP7ES	2412	0,8	BP7EVX	7270	206		BPR7EIX	4055
XT 250 (3Y3)	250	80 -	82	DR8ESL	2923	0,6	DR8EVX	6354	218		DR8EIX	6681
XT 250 H	250	-	84	BP7ES	2412	0,8	BP7EVX	7270	206		BPR7EIX	4055
XV 250	250	94 -		CR6HSA	2983	0,7					CR6HIX	7274
XV 250 (3LS,3LW)	250	89 -		CR6HS	7023	0,7			223		CR6HIX	7274
XV 250 F	250	94 -		C6HSA	3228	0,7					CR6HIX	7274
XV 250 S (3LW)	250	95 -		CR6HS	7023	0,8			223		CR6HIX	7274
XVS 250 (VG031)	250	01 -		CR6HS	7023	0,7			223		CR6HIX	7274
YZ 250 (4MX)	250	95 -		B8EG	3430	0,7	B8EGV	5627				
YZ 250 (2VM,3JE,3SP,3XK)	250	88 -	91	B8EG	3430	0,6	B8EGV	5627				
YZ 250 (39X,56A,1LU,2HH)	250	84 -	87	B8EG	3430	0,6	B8EGV	5627				
YZ 250 (4DA,4EW)	250	92 -		B8EG	3430	0,6	B8EGV	5627				
YZ 250 (5X5,24Y)	250	82 -	83	B9EG	3530	0,6	B9EGV	5827			BR9EIX	3981
YZ 250 F	250	94 -		B8EG	3430	0,6	B8EGV	5627				
YZ 250 F (CG10C)	250	01 -		CR8E	1275	0,7	CR8EVX	6487	226		CR8EIX	4218
XVZ 13 (3JS)	300	89 -	92	DPR8EA-9	4929	0,9	DPR8EVX-9	2872	221		DR8EIX-9	2202
BW 350	350			DR8ESL	2923	0,9	DR8EVX	6354	218		DR8EIX	6681
RD 350	350	87 -		BR9ES	5722	0,8	BR9EVX	1265	208		BR9EIX	3981
RD 350 12,7mm	350			B8HS	5510	0,7	B8HVX	2634	205		BR8HIX	7001
RD 350 19,0mm	350			B8ES	2411	0,8	B8EVX	7051	201		BR8EIX	5044
RD 350 C	350			B8ES	2411	0,8	B8EVX	7051	201		BR8EIX	5044



Order No.



Gold-Palladium



Platin

Order No.

Quick-No.

Iridium



Order No.

YAMAHA

RD 350 H 12,7mm (351)	350	73 - 74	B8HS	5510	0,7	B8HVX	2634	205	BR8HIX	7001
RD 350 H 19,0mm (521)	350	75 -	B8ES	2411	0,8	B8EVX	7051	201	BR8EIX	5044
RD 350 J	350		B8ES	2411	0,8	B8EVX	7051	201	BR8EIX	5044
RD 350 LC	350	- 85	BR8ES	5422	0,8	BR8EVX	1262	207	BR8EIX	5044
RD 350 LC (1WX,1WW)	350	86 - 89	BR9ES	5722	0,8	BR9EVX	1265	208	BR9EIX	3981
RD 350 LCF	350	86 -	BR9ES	5722	0,8	BR9EVX	1265	208	BR9EIX	3981
TT 350 (1TJ)	350	86 - 89	D8EA	2120	0,7	D8EVX	2850	216	DR8EIX	6681
TT 350 E / F	350	93 -	D8EA	2120	0,7	D8EVX	2850	216	DR8EIX	6681
TZ 350 B	350		B10EG	3630	0,6	B10EGV	5927			
TZ 350 H	350		B10EG	3630	0,6	B10EGV	5927			
XT 350 (3YT)	350	91 -	DR8ESL	2923	0,6	DR8EVX	6354	218	DR8EIX	6681
XT 350 (55V)	350	85 - 90	DR8ESL	2923	0,7	DR8EVX	6354	218	DR8EIX	6681
XT 350 E / F	350	93 -	D8EA	2120	0,7	D8EVX	2850	216	DR8EIX	6681
DT 360 (RT2)	360	01.73 -12.75	B9ES	2611	0,8	B9EVX	7254	202	BR9EIX	3981
MX 360	360				0,6	B8EVX	7051		BR8EIX	5044
XS 360 (1V4)	360	01.77 -12.78	BP6ES	7811	0,8	BP6EVX	5832		BPR6EIX	6637
YZ 360	360				0,6	B8EVX	7051		BR8EIX	5044
DT 400 (513)	400	11.75 -12.76	B8ES	2411	0,8	B8EVX	7051	201	BR8EIX	5044
DT 400 E	400		B9ES	2611	0,8	B9EVX	7254	202	BR9EIX	3981
DT 400 H	400		B8ES	2411	0,8	B8EVX	7051	201	BR8EIX	5044
DT 400 MX (1R6)	400	77 - 80	B8ES	2411	0,8	B8EVX	7051	201	BR8EIX	5044
FZR 400	400	04.87 -	CR8E	1275	0,7	CR8EVX	6487	226	CR8EIX	4218
IT 400	400		B8ES	2411	0,8	B8EVX	7051	201	BR8EIX	5044
IT 400 E	400				0,6	B8EVX	7051		BR8EIX	5044
MX 400	400				0,6	B8EVX	7051		BR8EIX	5044
RD 400 (1A3)	400	76 - 79	B8ES	2411	0,8	B8EVX	7051	201	BR8EIX	5044
RD 400 E	400		B8ES	2411	0,8	B8EVX	7051	201	BR8EIX	5044
SR 400	400		BP7ES	2412	0,8	BP7EVX	7270	206	BPR7EIX	4055
TT 400 C	400				0,6	B8EVX	7051		BR8EIX	5044
WR 400 F	400	98 -	CR8E	1275	0,7	CR8EVX	6487	226	CR8EIX	4218
XJ 400	400		D8EA	2120	0,7	D8EVX	2850	216	DR8EIX	6681
XS 400 (12E)	400	82 - 89	DR8ESL	2923	0,7	DR8EVX	6354	218	DR8EIX	6681
XS 400 (2A2)	400	78 - 82	BP7ES	2412	0,8	BP7EVX	7270	206	BPR7EIX	4055
XS 400 SE (465)	400	80 - 82	BP7ES	2412	0,8	BP7EVX	7270	206	BPR7EIX	4055
XT 400	400	84 -	DR7ES	3123	0,7					
XT 400	400	- 83	BP7ES	2412	0,8	BP7EVX	7270	206	BPR7EIX	4055
XV 400 SE	400		BPR7ES	2023	0,8	BPR7EVX	5565		BPR7EIX	4055
YP 400 Majesty	400	05 -	CR7E	4578	0,6			225	CR7EIX	7385
YZ 400	400				0,6	B8EVX	7051		BR8EIX	5044
YZ 400 C	400				0,6	B8EVX	7051		BR8EIX	5044
YZ 400 E	400				0,6	B8EVX	7051		BR8EIX	5044
YZ 400 F	400	12.97 -	CR8E	1275	0,7	CR8EVX	6487	226	CR8EIX	4218
IT 425	425		B8ES	2411	0,8	B8EVX	7051	201	BR8EIX	5044
WR 426 F (CJ02W)	426	01 -	CR8E	1275	0,7	CR8EVX	6487	226	CR8EIX	4218
YZF 426 F	426	01 -	CR8E	1275	0,6	CR8EVX	6487	226	CR8EIX	4218
WR 450 F (5TJ6)	450	03 -	CR8E	1275	0,7	CR8EVX	6487	226	CR8EIX	4218
YZ 450 F	450	03 -	CR8E	1275	0,7	CR8EVX	6487	226	CR8EIX	4218
IT 465 (4V6)	465	81 -	B8ES	2411	0,8	B8EVX	7051	201	BR8EIX	5044
IT 465 H	465		B8ES	2411	0,8	B8EVX	7051	201	BR8EIX	5044
YZ 465	465		B8ES	2411	0,8	B8EVX	7051	201	BR8EIX	5044
YZ 465 H	465		B8ES	2411	0,8	B8EVX	7051	201	BR8EIX	5044
IT 490 (29W)	490	83 - 85	BR8ES	5422	0,6	BR8EVX	1262	207	BR8EIX	5044



Order No.



Gold-Palladium



Platin

Order No.

Quick-No.

Iridium



Order No.

YAMAHA

YZ 490	490			BR9EG	3230	0,6	BR9EVX	1265		BR9EIX	3981
IT 500	500			BP7ES	2412	0,7	BP7EVX	7270	206	BPR7EIX	4055
MX 500	500					0,6	B8EVX	7051		BR8EIX	5044
RD 500 LC (1GE)	500	85 -	86	BR9HS	4522	0,7					
RD 500 LC (47X)	500		84	BR9HS	4522	0,7					
SR 500 (3EB)	500	95 -		BPR7ES	2023	0,6	BPR7EVX	5565		BPR7EIX	4055
SR 500 (2J4,48T)	500	01.79 -	96	BP7ES	2412	0,8	BP7EVX	7270	206	BPR7EIX	4055
SR 500 (48T)	500	97 -		BPR7ES	2023	0,8	BPR7EVX	5565		BPR7EIX	4055
SR 500 E	500			BP7ES	2412	0,8	BP7EVX	7270	206	BPR7EIX	4055
SR 500 H	500			BP7ES	2412	0,8	BP7EVX	7270	206	BPR7EIX	4055
TT 500 (1T1)	500	78 -	79	BP7ES	2412	0,8	BP7EVX	7270	206	BPR7EIX	4055
TT 500 C	500			BP7ES	2412	0,8	BP7EVX	7270	206	BPR7EIX	4055
TT 500 E	500			BP7ES	2412	0,8	BP7EVX	7270	206	BPR7EIX	4055
TT 500 H	500			BP7ES	2412	0,8	BP7EVX	7270	206	BPR7EIX	4055
TZ 500	500					0,6	B10EVX	7335		BR10EIX	6801
TZ 500 H	500					0,6	B10EVX	7335		BR10EIX	6801
XJ 500	500			D8EA	2120	0,7	D8EVX	2850	216	DR8EIX	6681
XS 500 (1H2)	500	77 -	79	D8EA	2120	0,7	D8EVX	2850	216	DR8EIX	6681
XS 500 E	500			D8EA	2120	0,7	D8EVX	2850	216	DR8EIX	6681
XT 500 (1E6,1V6)	500	76 -	89	BP7ES	2412	0,8	BP7EVX	7270	206	BPR7EIX	4055
XT 500 C	500			BP7ES	2412	0,8	BP7EVX	7270	206	BPR7EIX	4055
XT 500 E	500	93 -		DPR8EA-9	4929	0,9	DPR8EVX-9	2872	221	DPR8EIX-9	2202
XT 500 E	500		92	BP7ES	2412	0,8	BP7EVX	7270	206	BPR7EIX	4055
XT 500 H	500			BP7ES	2412	0,8	BP7EVX	7270	206	BPR7EIX	4055
XT 500 T	500			DPR8EA-9	4929	0,9	DPR8EVX-9	2872	221	DPR8EIX-9	2202
XT 500 Z	500			DPR8EA-9	4929	0,9	DPR8EVX-9	2872	221	DPR8EIX-9	2202
XV 500 (I)	500			BPR7ES	2023	0,8	BPR7EVX	5565		BPR7EIX	4055
XV 500 SE (26R)	500	83 -	87	BPR7ES	2023	0,8	BPR7EVX	5565		BPR7EIX	4055
YP 500 Tmax ABS	500	05 -		CR7E	4578	0,6			225	CR7EIX	7385
XV 535 DX (N) VJ012 25kW	535	00 -		BPR6ES	7822	0,8	BPR6EVX	6764		BPR6EIX	6637
XV 535 DX (H) VJ011 32kW	535	00 -		BPR6ES	7822	0,8	BPR6EVX	6764		BPR6EIX	6637
XV 535 (2YL,3BR)	535	88 -	96	BPR7ES	2023	0,8	BPR7EVX	5565		BPR7EIX	4055
XV 535 (4KU / 4MC)	535	95 -		BPR7ES	2023	0,8	BPR7EVX	5565		BPR7EIX	4055
XV 535 S / SP (2YL,3BR)	535	93 -	96	BPR7ES	2023	0,8	BPR7EVX	5565		BPR7EIX	4055
XV 535/S(h) (2YL)	535	97 -	99	BPR6ES	7822	0,8	BPR6EVX	6764		BPR6EIX	6637
XV 535/S(n) (3BR)	535	97 -	99	BPR6ES	7822	0,8	BPR6EVX	6764		BPR6EIX	6637
YV 535 FC	535	94 -		BP7ES	2412	0,8	BP7EVX	7270	206	BPR7EIX	4055
XJ 550 (4V8)	550	81 -	83	D8EA	2120	0,6	D8EVX	2850	216	DR8EIX	6681
XJ 550 H	550			D8EA	2120	0,6	D8EVX	2850	216	DR8EIX	6681
XJ 550 RH	550			D8EA	2120	0,6	D8EVX	2850	216	DR8EIX	6681
XT 550 (5Y3)	550	82 -	83	DR7ES	3123	0,6					
XZ 550 (11V)	550	82 -	84	DR8ESL	2923	0,6	DR8EVX	6354	218	DR8EIX	6681
XZ 550 S (11V)	550	83 -	84	DR8ESL	2923	0,7	DR8EVX	6354	218	DR8EIX	6681
FZ 6 Fazer	600	04 -		CR9EK	4548	0,7				CR9EIX	3521
FZ 600, -U	600			DR8ESL	2923	0,7	DR8EVX	6354	218	DR8EIX	6681
FZR 600 (3HE,3RG,3RH)	600	89 -	93	CR9E	6263	0,7	CR9EVX	5943	227	CR9EIX	3521
FZR 600 F / R / RF / RFC	600	94 -		CR9E	6263	0,7	CR9EVX	5943	227	CR9EIX	3521
FZR 600 R (4JH) 72kW	600	94 -		CR9E	6263	0,7	CR9EVX	5943	227	CR9EIX	3521
FZR 600 R (4MH) 25kW	600	94 -		CR9E	6263	0,7	CR9EVX	5943	227	CR9EIX	3521
FZS 600 Fazer (R.J021)(5DM)	600	98 -	02	CR9E	6263	0,7	CR9EVX	5943	227	CR9EIX	3521
FZS 600 Fazer (R.J022)	600	98 -	02	CR8E	1275	0,7	CR8EVX	6487	226	CR8EIX	4218
FZS 600 Fazer	600	03 -	04	CR9EK	4548	0,7			230	CR9EIX	3521



Order No.



Gold-Palladium



Platin

Order No.







Quick-No.



Order No.

YAMAHA

SRX 600 (1XM,1XN)	600	86 - 89	DPR7EA-9	5129	0,9	DPR7EVX-9	7682	220	DPR7EIX-9	7803
TT 600	600	86 -	DPR7EA-9	5129	0,9	DPR7EVX-9	7682	220	DPR7EIX-9	7803
TT 600 RE (DJ012)	600	03 -	DPR8EA-9	4929	0,9	DPR8EVX-9	2872	221	DPR8EIX-9	2202
TT 600 (36A)	600	83 - 85	D7EA	7912	0,6	D7EVX	2734			
TT 600 E (4LW)	600	93 -	DPR8EA-9	4929	0,9	DPR8EVX-9	2872	221	DPR8EIX-9	2202
TT 600 R (DJ011)	600	98 -	DPR9EA-9	5329	0,9	DPR9EVX-9	3854	222	DPR9EIX-9	5545
TT 600 S (4LW)	600	93 -	DPR8EA-9	4929	0,9	DPR8EVX-9	2872	221	DPR8EIX-9	2202
TT 600 S (59X) (I)	600	85 - 89	DPR7EA-9	5129	0,9	DPR7EVX-9	7682	220	DPR7EIX-9	7803
XJ 600 (51J,3KM,3KN)	600	84 - 90	DR8ESL	2923	0,7	DR8EVX	6354	218	DR8EIX	6681
XJ 600 N (4KA)	600	95 -	CR8E	1275	0,6	CR8EVX	6487	226	CR8EIX	4218
XJ 600 N (4MB)	600	95 -	CR8E	1275	0,6	CR8EVX	6487	226	CR8EIX	4218
XJ 600 N (h) (4BR)	600	97 -	CR8E	1275	0,6	CR8EVX	6487	226	CR8EIX	4218
XJ 600 N (n) (4LX)	600	97 -	CR7E	4578	0,6			225	CR7EIX	7385
XJ 600 S (4EB / 4LX)	600	95 - 96	CR8E	1275	0,6	CR8EVX	6487	226	CR8EIX	4218
XJ 600 S (4BR,4BRA,4BRB)	600	91 - 96	CR8E	1275	0,7	CR8EVX	6487	226	CR8EIX	4218
XJ 600 S (h) (4BR)(1R..)	600	97 -	CR8E	1275	0,6	CR8EVX	6487	226	CR8EIX	4218
XJ 600 S (n) (4LX)	600	97 -	CR7E	4578	0,7			225	CR7EIX	7385
XJ 600 S / N (4LX)	600	94 - 96	CR9E	6263	0,8	CR9EVX	5943	227	CR9EIX	3521
XT 600 (2KF,2NF)	600	87 - 90	DPR8EA-9	4929	0,9	DPR8EVX-9	2872	221	DPR8EIX-9	2202
XT 600 (43F)	600	84 - 87	DR7ES	3123	0,6					
XT 600 E (4PT / 4SK)	600	95 -	DPR8EA-9	4929	0,9	DPR8EVX-9	2872	221	DPR8EIX-9	2202
XT 600 E / EF / EFC	600	94 -	DPR8EA-9	4929	0,9	DPR8EVX-9	2872	221	DPR8EIX-9	2202
XT 600 E(h) (3TB)	600	97 -	DPR8EA-9	4929	0,9	DPR8EVX-9	2872	221	DPR8EIX-9	2202
XT 600 E(n) (3UW)	600	97 -	DPR8EA-9	4929	0,9	DPR8EVX-9	2872	221	DPR8EIX-9	2202
XT 600 E/K (3TB/3UW)	600	90 - 94	DPR8EA-9	4929	0,9	DPR8EVX-9	2872	221	DPR8EIX-9	2202
XT 600 S	600	86 - 86	DPR8EA-9	4929	0,9	DPR8EVX-9	2872	221	DPR8EIX-9	2202
XT 600 Z (34L,55W)	600	83 - 85	DR7ES	3123	0,6					
XT 600 Z Tenere (1VJ,3AJ)	600	86 -	DPR7EA-9	5129	0,9	DPR7EVX-9	7682	220	DPR7EIX-9	7803
YX 600	600		DR8ESL	2923	0,7	DR8EVX	6354	218	DR8EIX	6681
YZF 600 R (4WD)	600	96 -	CR9E	6263	0,8	CR9EVX	5943	227	CR9EIX	3521
YZF 600 R (4TV)	600	96 -	CR9E	6263	0,8	CR9EVX	5943	227	CR9EIX	3521
YZF-R6 / S	600	03 - 05	CR10EK	2360	0,6				CR10EIX	6482
YZF-R6	600	06 -	CR10EK	2360	0,6				CR10EIX	6482
YZF-R6 (RJ031/032)	600	99 -	CR10EK	2360	0,6				CR10EIX	6482
Drag Star (4VR/4XR)	650	97 -	DPR7EA-9	5129	0,9	DPR7EVX-9	7682	220	DPR7EIX-9	7803
TS 650	650		B8ES	2411	0,6	B8EVX	7051	201	BR8EIX	5044
XJ 650 (4K0)	650	80 - 83	BP7ES	2412	0,7	BP7EVX	7270	206	BPR7EIX	4055
XJ 650 H	650		BP7ES	2412	0,7	BP7EVX	7270	206	BPR7EIX	4055
XJ 650 LH	650		BP7ES	2412	0,7	BP7EVX	7270	206	BPR7EIX	4055
XJ 650 SH	650		BP7ES	2412	0,7	BP7EVX	7270	206	BPR7EIX	4055
XJ 650 T (Turbo) (11T)	650	82 -	BPR8ES	3923	0,7	BPR8EVX	5573	213		
XS 650 (447)	650	76 - 83	BP8ES	2912	0,7	BP8EVX	2671			
XS 650 (I)	650		BP7ES	2412	0,7	BP7EVX	7270	206	BPR7EIX	4055
XS 650 E	650		BP7ES	2412	0,7	BP7EVX	7270	206	BPR7EIX	4055
XS 650 H	650		BP7ES	2412	0,7	BP7EVX	7270	206	BPR7EIX	4055
XS 650 II	650		BP7ES	2412	0,7	BP7EVX	7270	206	BPR7EIX	4055
XS 650 S	650		BP7ES	2412	0,7	BP7EVX	7270	206	BPR7EIX	4055
XS 650 SE (3L1)	650	79 - 81	BP7ES	2412	0,7	BP7EVX	7270	206	BPR7EIX	4055
XS 650 SH	650		BP7ES	2412	0,7	BP7EVX	7270	206	BPR7EIX	4055
XVS 650 (4VR)	650	97 -	DPR7EA-9	5129	0,9	DPR7EVX-9	7682	220	DPR7EIX-9	7803
XVS 650 Drag Star Classic (VM022)	650	98 -	DPR7EA-9	5129	0,9	DPR7EVX-9	7682	220	DPR7EIX-9	7803
XVS 650 Drag Star Classic (VM025)	650	98 -	DPR7EA-9	5129	0,9	DPR7EVX-9	7682	220	DPR7EIX-9	7803

					Order No.		Platin 	Order No.	Quick-No. 	Iridium	Order No.
YAMAHA											
XVS 650 (4XR)	650	97 -	DPR7EA-9	5129	0,9		DPR7EVX-9	7682	220	DPR7EIX-9	7803
MT 03	660	06 -	CR7E	4578	0,6				225	CR7EIX	7385
SZR 660 (4SU)	660	96 - 96	DPR9EA-9	5329	0,9		DPR9EVX-9	3854	222	DPR9EIX-9	5545
SZR 660 (4SU)	660	97 -	DPR8EA-9	4929	0,9		DPR8EVX-9	2872	221	DPR8EIX-9	2202
XT 660 X	660	04 -	CR7E	4578	0,6				225	CR7EIX	7385
XT 660 R	660	04 -	CR7E	4578	0,6				225	CR7EIX	7385
XTZ 660 (4MD)	660	94 -	DR8EA	7162	0,9		DR8EVX	6354		DR8EIX	6681
XTZ 660 (3YF)	660	97 -	DPR8EA-9	4929	0,9		DPR8EVX-9	2872	221	DPR8EIX-9	2202
XTZ 660 (3YF)	660	91 - 93	DPR9EA-9	5329	0,9		DPR9EVX-9	3854	222	DPR9EIX-9	5545
750 Laguna Seca (11M)	750	82 -	BP7ES	2412	0,7		BP7EVX	7270	206	BPR7EIX	4055
FZ 750 (1FN)	750	85 - 86	DR8ESL	2923	0,7		DR8EVX	6354	218	DR8EIX	6681
FZ 750 (3KT)	750	91 -	DR8ESL	2923	0,6		DR8EVX	6354	218	DR8EIX	6681
FZ 750 Genesis (2KK)	750	87 - 90	DR8ESL	2923	0,6		DR8EVX	6354	218	DR8EIX	6681
FZR 750 R (3PJ,3CV)	750	88 - 92	DR8EA	7162	0,7		DR8EVX	6354		DR8EIX	6681
FZX 750 (2JE)	750	87 - 89	DR8ESL	2923	0,6		DR8EVX	6354	218	DR8EIX	6681
FZX 750 Phaser (I)	750		DR8ESL	2923	0,7		DR8EVX	6354	218	DR8EIX	6681
TZ 750	750		B10EG	3630	0,5		B10EGV	5927			
TZ 750 D	750				0,6		B10EVX	7335		BR10EIX	6801
XJ 750	750	- 83	B7ES	1111	0,7		B7EVX	6934			
XJ 750 (41Y)	750	84 - 85	BPR8ES	3923	0,7		BPR8EVX	5573	213		
XJ 750 RH	750		B7ES	1111	0,7		B7EVX	6934			
XS 750 (1T5)	750	77 - 79	B7ES	1111	0,7		B7EVX	6934			
XS 750 C	750		B7ES	1111	0,7		B7EVX	6934			
XS 750 D	750		B7ES	1111	0,7		B7EVX	6934			
XS 750 E	750		B7ES	1111	0,7		B7EVX	6934			
XS 750 S	750		B7ES	1111	0,7		B7EVX	6934			
XS 750 SE	750		B7ES	1111	0,7		B7EVX	6934			
XS 750 T	750		B7ES	1111	0,7		B7EVX	6934			
XTS 750 SE	750		B7ES	1111	0,7		B7EVX	6934			
XTZ 750 (3LD, 3WM)	750	89 -	DPR8EA-9	4929	0,9		DPR8EVX-9	2872	221	DPR8EIX-9	2202
XV 750	750	- 83	B7ES	1111	0,7		B7EVX	6934			
XV 750 (4PW)	750	95 -	BPR7ES	2023	0,8		BPR7EVX	5565		BPR7EIX	4055
XV 750 / F / FC	750	84 -	BPR7ES	2023	0,7		BPR7EVX	5565		BPR7EIX	4055
XV 750 SE (5G5)	750	81 - 82	B7ES	1111	0,7		B7EVX	6934			
XV 750 SE (I)	750		BP7ES	2412	0,7		BP7EVX	7270	206	BPR7EIX	4055
YZF 750 SP / SPF (4HT)	750	93 -	CR9E	6263	0,8		CR9EVX	5943	227	CR9EIX	3521
YZF-R7 (RM011)	750	01 -	R-0256R-10	7641	1,0						
TDM 850 (4TX)	850	96 - 96	DPR9EA-9	5329	0,9		DPR9EVX-9	3854	222	DPR9EIX-9	5545
TDM 850 (3VD)	850	97 -	DPR8EA-9	4929	0,9		DPR8EVX-9	2872	221	DPR8EIX-9	2202
TDM 850 (4TX)	850	97 -	DPR8EA-9	4929	0,9		DPR8EVX-9	2872	221	DPR8EIX-9	2202
TDM 850 / F (3VD)	850	91 - 95	DPR8EA-9	4929	0,9		DPR8EVX-9	2872	221	DPR8EIX-9	2202
TRX 850	850	95 - 95	DPR8EA-9	4929	0,9		DPR8EVX-9	2872	221	DPR8EIX-9	2202
TRX 850 (4UN)	850	96 - 96	DPR9EA-9	5329	0,9		DPR9EVX-9	3854	222	DPR9EIX-9	5545
TRX 850 (4UN)	850	97 -	DPR8EA-9	4929	0,9		DPR8EVX-9	2872	221	DPR8EIX-9	2202
XS 850 (4E2)	850	80 - 81	BP7ES	2412	0,7		BP7EVX	7270	206	BPR7EIX	4055
XS 850 H	850		BP7ES	2412	0,7		BP7EVX	7270	206	BPR7EIX	4055
XS 850 LH	850		BP7ES	2412	0,7		BP7EVX	7270	206	BPR7EIX	4055
XS 850 SH	850		BP7ES	2412	0,7		BP7EVX	7270	206	BPR7EIX	4055
TDM 900	900	02 -	DPR8EA-9	4929	0,9		DPR8EVX-9	2872	221	DPR8EIX-9	2202
XJ 900 (31A)	900	83 - 84	BPR8ES	3923	0,7		BPR8EVX	5573	213		
XJ 900 (4BB)	900	91 -	BPR8ES	3923	0,7		BPR8EVX	5573	213		
XJ 900 (58L)	900	85 - 90	BPR8ES	3923	0,7		BPR8EVX	5573	213		



Order No.



Gold-Palladium



Order No.

Quick-No.

Iridium



Order No.

YAMAHA

XJ 900 S (4KM)	900	95 -	DPR8EA-9	4929	0,9	DPR8EVX-9	2872	221	DPR8EIX-9	2202
XV 920 RH	920		BP7ES	2412	0,7	BP7EVX	7270	206	BPR7EIX	4055
FZ 1	1000	06 -	CR9EK	4548	0,7			230	CR9EIX	3521
FZ 1 Fazer	1000	06 -	CR9EK	4548	0,7			230	CR9EIX	3521
FZR 1000 / FC (3LE)	1000	94 -	DR8EA	7162	0,7	DR8EVX	6354		DR8EIX	6681
FZR 1000 EXUP (I)	1000		DR8ESL	2923	0,7	DR8EVX	6354	218	DR8EIX	6681
FZR 1000 F	1000	94 -	DP8EA-9	5829	0,9	DPR8EVX-9	2872		DPR8EIX-9	2202
FZR 1000 / U	1000		DR8ESL	2923	0,7	DR8EVX	6354	218	DR8EIX	6681
FZS 1000 Fazer(RN064)	1000	01 -	CR9E	6263	0,7	CR9EVX	5943	227	CR9EIX	3521
GTS 1000 (4BH)	1000	92 -	DPR8EA-9	4929	0,9	DPR8EVX-9	2872	221	DPR8EIX-9	2202
GTS 1000 A / AF / AFC (4BH)	1000	92 -	DPR8EA-9	4929	0,9	DPR8EVX-9	2872	221	DPR8EIX-9	2202
TR1 (578)	1000	81 - 82	BPR7ES	2023	0,7	BPR7EVX	5565		BPR7EIX	4055
XV 1000 / F / FC	1000		BPR7ES	2023	0,7	BPR7EVX	5565		BPR7EIX	4055
XV 1000 SE (23W,2AE)	1000	83 - 88	BPR7ES	2023	0,7	BPR7EVX	5565		BPR7EIX	4055
XV 1000 SH	1000		BPR7ES	2023	0,7	BPR7EVX	5565		BPR7EIX	4055
YZF R1 (RN012)(RN04)	1000	98 - 01	CR9E	6263	0,7	CR9EVX	5943	227	CR9EIX	3521
YZF R1 (5PW1; 5PW2)	1000	02 - 03							CR9EIA-9	6289
YZF 1000 R (4VD)	1000	96 - 02	DR8EA	7162	0,7	DR8EVX	6354		DR8EIX	6681
YZF-R1 / SP	1000	04 -	CR9EK	4548	0,7			230	CR9EIX	3521
BT 1100 Bulldog	1100	02 -	BPR7ES	2023	0,6	BPR7EVX	5565		BPR7EIX	4055
FJ 1100 (47E)	1100	84 - 85	DPR8EA-9	4929	0,9	DPR8EVX-9	2872	221	DPR8EIX-9	2202
XS 1100 (2H9)	1100	78 - 82	BP6ES	7811	0,7	BP6EVX	5832		BPR6EIX	6637
XS 1100 E	1100		BP6ES	7811	0,7	BP6EVX	5832		BPR6EIX	6637
XS 1100 H	1100		BP6ES	7811	0,7	BP6EVX	5832		BPR6EIX	6637
XS 1100 LH	1100		BP6ES	7811	0,7	BP6EVX	5832		BPR6EIX	6637
XS 1100 RH	1100		BP6ES	7811	0,7	BP6EVX	5832		BPR6EIX	6637
XS 1100 S (5K7)	1100	81 - 82	BP6ES	7811	0,7	BP6EVX	5832		BPR6EIX	6637
XS 1100 SH	1100		BP6ES	7811	0,7	BP6EVX	5832		BPR6EIX	6637
XV 1100 (3LP)	1100	95 -	BPR7ES	2023	0,8	BPR7EVX	5565		BPR7EIX	4055
XV 1100 SC	1100		BPR7ES	2023	0,8	BPR7EVX	5565		BPR7EIX	4055
XVS 1100 Drag Star (VP05)	1100	99 -	BPR7ES	2023	0,7	BPR7EVX	5565		BPR7EIX	4055
FJ 1200 (1XJ)	1200	86 - 87	DPR8EA-9	4929	0,9	DPR8EVX-9	2872	221	DPR8EIX-9	2202
FJ 1200 (3CW)	1200	88 - 90	DPR8EA-9	4929	0,9	DPR8EVX-9	2872	221	DPR8EIX-9	2202
FJ 1200 (3YA)	1200	91 -	DPR8EA-9	4929	0,9	DPR8EVX-9	2872	221	DPR8EIX-9	2202
FJ 1200 AE/ AEC / E / F	1200	93 -	DP8EA-9	5829	0,9	DPR8EVX-9	2872		DPR8EIX-9	2202
Vmax 1200 (2EN)	1200	97 -	DPR8EA-9	4929	0,9	DPR8EVX-9	2872	221	DPR8EIX-9	2202
Vmax 1200 / F / FC	1200		DPR8EA-9	4929	0,9	DPR8EVX-9	2872	221	DPR8EIX-9	2202
XJR 1200 (4PU)	1200	95 -	DPR8EA-9	4929	0,9	DPR8EVX-9	2872	221	DPR8EIX-9	2202
XJR 1200 (4PU)	1200	97 -	DPR8EA-9	4929	0,9	DPR8EVX-9	2872	221	DPR8EIX-9	2202
XVZ 1200 TD	1200		DPR8EA-9	4929	0,9	DPR8EVX-9	2872	221	DPR8EIX-9	2202
XVZ 12T (47G)	1200	84 - 87	DPR8EA-9	4929	0,9	DPR8EVX-9	2872	221	DPR8EIX-9	2202
FJR 1300	1300	01 -	CR8E	1275	0,7	CR8EVX	6487	226	CR8EIX	4218
FJR 1300 A	1300	03 -	CR8E	1275	0,7	CR8EVX	6487	226	CR8EIX	4218
Royal Star(4YP)	1300	97 -	DPR7EA-9	5129	0,9	DPR7EVX-9	7682	220	DPR7EIX-9	7803
XJR 1300	1300	98 -	DPR8EA-9	4929	0,9	DPR8EVX-9	2872	221	DPR8EIX-9	2202
XJR 1300 (RP022)	1300	99 -	DPR8EA-9	4929	0,9	DPR8EVX-9	2872	221	DPR8EIX-9	2202
XJR 1300 SP (RP022)	1300	99 -	DPR8EA-9	4929	0,9	DPR8EVX-9	2872	221	DPR8EIX-9	2202
XVZ 13 A (4NK)	1300	97 -	DPR7EA-9	5129	0,9	DPR7EVX-9	7682	220	DPR7EIX-9	7803
XVZ 13 A (4YP)	1300	97 -	DPR7EA-9	5129	0,9	DPR7EVX-9	7682	220	DPR7EIX-9	7803
XVZ 13DE	1300	93 -	DPR8EA-9	4929	0,9	DPR8EVX-9	2872	221	DPR8EIX-9	2202
XV 1600 Wild Star (VP981)	1600	03.99 -	DPR7EA-9	5129	0,9	DPR7EVX-9	7682	220	DPR7EIX-9	7803
MT-01	1670	05 -	DPR7EA-9	5129	0,9	DPR7EVX-9	7682	220	DPR7EIX-9	7803



Order No.



Gold-Palladium



Order No.

Quick-No.

Iridium



Order No.

YAMAHA

XU 1700 Road Star Warrior	1670	03 -	DPR7EA-9	5129	0,9	DPR7EVX-9	7682	220	DPR7EIX-9	7803
XV 1900	1900	06 -	DPR8EA-9	4929	0,9	DPR8EVX-9	2872	221	DPR8EIX-9	2202

ZID

Sova 175	175	93 -	BP7HS	5111	0,6	BP7HVX	7468		BPR7HIX	5944
Woshod 124.000-01-900 7,7kW	175		BP7HS	5111	0,7	BP7HVX	7468		BPR7HIX	5944
Woshod 128.000-01-900 10,3kW	175		BP7HS	5111	0,7	BP7HVX	7468		BPR7HIX	5944
Woshod 144.000-01-900 9,9kW	175		BP7HS	5111	0,7	BP7HVX	7468		BPR7HIX	5944
Fermer 3DK5.904 9,6kW	197		BP7HS	5111	0,7	BP7HVX	7468		BPR7HIX	5944
Zid-200 3DK5.104 11,1kW	197		BP7HS	5111	0,7	BP7HVX	7468		BPR7HIX	5944
Sova 11kW	200		BP7HS	5111	0,7	BP7HVX	7468		BPR7HIX	5944

ZÜNDAPP

Automatic Mofa	50		B5HS	4210	0,5					
Automatic Moped	50		B6HS	4510	0,6	B6HVX	7435	203	BR6HIX	3419
C 50 Sport	50		B6HS	4510	0,6	B6HVX	7435	203	BR6HIX	3419
C 50 Super	50		B6HS	4510	0,6	B6HVX	7435	203	BR6HIX	3419
Combinette	50		B6HS	4510	0,6	B6HVX	7435	203	BR6HIX	3419
CS 50	50		BP5ES	6511	0,7	BP5EVX	5470		BPR5EIX	6597
CS25	50		BP5ES	6511	0,7	BP5EVX	5470		BPR5EIX	6597
GTS 50 (5 Gang)	50		BP5ES	6511	0,7	BP5EVX	5470		BPR5EIX	6597
GTS 50 Super	50		B6HS	4510	0,6	B6HVX	7435	203	BR6HIX	3419
Hai 25	50		BP5ES	6511	0,7	BP5EVX	5470		BPR5EIX	6597
Hai 50	50		BP6ES	7811	0,6	BP6EVX	5832		BPR6EIX	6637
High Riser 44	50		BP5HS	4111	0,5					
KS 50 12.7 mm Gewindelänge	50		B7HS	5110	0,5	B7HVX	7836	204	BR7HIX	7067
KS 50 19.0 mm Gewindelänge	50		B7ES	1111	0,5	B7EVX	6934			
KS 50 Cross / Sport 517	50		B8HS	5510	0,5	B8HVX	2634	205	BR8HIX	7001
KS 50 Sport / Super Sport	50		B8HS	5510	0,5	B8HVX	2634	205	BR8HIX	7001
KS 50 TT/WK	50		B9ES	2611	0,5	B9EVX	7254	202	BR9EIX	3981
M 50, Moped-Automatic, Mofa 25	50		B5HS	4210	0,5					
R 50, Sport-Comb, Super Comb	50		B6HS	4510	0,6	B6HVX	7435	203	BR6HIX	3419
RS 50 Super	50		B7HS	5110	0,5	B7HVX	7836	204	BR7HIX	7067
ZA 25, ZB 22, ZD 10/20/25TS	50		B5HS	4210	0,5					
ZA 40, ZD 80/40, ZR 30	50		B6HS	4510	0,6	B6HVX	7435	203	BR6HIX	3419
ZD 50TS, ZR10/20, ZX25	50		B5HS	4210	0,5					
ZL 25	50		BP5ES	6511	0,7	BP5EVX	5470		BPR5EIX	6597
KS 75	75		B8HS	5510	0,5	B8HVX	2634	205	BR8HIX	7001
K 80	80		B8ES	2411	0,5	B8EVX	7051	201	BR8EIX	5044
KS 80	80		B8ES	2411	0,5	B8EVX	7051	201	BR8EIX	5044
KS 80 Super	80		B8ES	2411	0,5	B8EVX	7051	201	BR8EIX	5044
KS 80 Touring	80		B8ES	2411	0,5	B8EVX	7051	201	BR8EIX	5044
100 ISDT	100		B8HS	5510	0,5	B8HVX	2634	205	BR8HIX	7001
100 Scrambler	100		B8HS	5510	0,5	B8HVX	2634	205	BR8HIX	7001
KS 100	100		B8HS	5510	0,5	B8HVX	2634	205	BR8HIX	7001
KS 125	125		B8HS	5510	0,5	B8HVX	2634	205	BR8HIX	7001
KS 125 GS	125		B8HS	5510	0,5	B8HVX	2634	205	BR8HIX	7001
KS 125 MC	125		B8HS	5510	0,5	B8HVX	2634	205	BR8HIX	7001
KS 175	175		B8ES	2411	0,5	B8EVX	7051	201	BR8EIX	5044
KS 350	350		B8ES	2411	0,5	B8EVX	7051	201	BR8EIX	5044
KS 600	600	38 -	BP6HS	4511	0,6	BP6HVX	4635		BPR6HIX	4085
KS 601	600		BP7HS	5111	0,5	BP7HVX	7468		BPR7HIX	5944



Order No.



Gold-Palladium



Platin

Order No.

Quick-No.







Iridium

















Order No.







APRILIA







Amico 25 (MK)	25	96 -	BR7HS	4122	0,5			211	BR7HIX	7067
Amico GL (HV)	50		BR7HS	4122	0,5			211	BR7HIX	7067
Amico LX / LK / Sport	50		BR7HS	4122	0,5			211	BR7HIX	7067
Amico 50	50	01.90 - 95	BR7HS	4122	0,6			211	BR7HIX	7067
Amico 50 Clubmann	50	97 -	BR7HS	4122	0,5			211	BR7HIX	7067
Area 51 (MY)	50	99 -	BR8HS	4322	0,7	BR8HVX	6265	212	BR8HIX	7001
Gulliver 50	50	01.95 - 96	BR7HS	4122	0,6			211	BR7HIX	7067
Gulliver 50 LC (LH)	50	96 -	BR8HS	4322	0,7	BR8HVX	6265	212	BR8HIX	7001
Gulliver 50 H2O	50	01.96 -	BR8HS	4322	0,6	BR8HVX	6265	212	BR8HIX	7001
Gulliver AC (LH)	50		BR7HS	4122	0,5			211	BR7HIX	7067
Habana 50 / Custom (PK)	50	99 -	BPR8HS	3725	0,6				BPR8HIX	6742
Mojito Custom 50	50	99 -	BPR8HS	3725	0,6				BPR8HIX	6742
MX 50 (RX50)	50	03 -	BR9ES	5722	0,6	BR9EVX	1265	208	BR9EIX	3981
Rally 50	50	01.95 - 96	BR8HS	4322	0,6	BR8HVX	6265	212	BR8HIX	7001
Rally 50 AC (MD)	50		BR7HS	4122	0,5			211	BR7HIX	7067
Rally 50 LC / Fun (MZ)	50	96 -	BR8HS	4322	0,5	BR8HVX	6265	212	BR8HIX	7001
Rally 50 H2O	50	01.96 -	BR8HS	4322	0,6	BR8HVX	6265	212	BR8HIX	7001
Scarabeo 50	50	93 - 03	BR7HS	4122	0,5			211	BR7HIX	7067
Scarabeo De Luxe (PF)	50	98 - 03	BR7HS	4122	0,5			211	BR7HIX	7067
Scarabeo 50 (DiTech)	50	07.00 -	CPR8E	7411	0,6					
Sonic 50 AC (PB)	50		BR7HS	4122	0,5			211	BR7HIX	7067
Sonic 50 LC (PB)	50		BR8HS	4322	0,6	BR8HVX	6265	212	BR8HIX	7001
Sonic 50 G.P. / Spice	50	01.98 -	BR8HS	4322	0,6	BR8HVX	6265	212	BR8HIX	7001
SR 50 R Factory (VFB) (DiTech)(PIAGGIO Motor)	50	05 -	CPR8E	7411	0,9	---			---	
SR 50 LC (TEA) Vergaser (PIAGGIO Motor)	50	05 -	BR9ES	5722	0,6	BR9EVX	1265	208	BR9EIX	3981
SR 50 i.e. (TE) (DiTech) (PIAGGIO Motor)	50	05 -	CPR8E	7411	0,9	---			---	
SR 50	50	01.92 - 96	BR7HS	4122	0,6			211	BR7HIX	7067
SR 50 H2O (I)	50	01.96 -	BR8HS	4322	0,6	BR8HVX	6265	212	BR8HIX	7001
SR 50 R (Vergaser)(PIAGGIO Motor)	50	05 -	BR9ES	5722	0,6	BR9EVX	1265	208	BR9EIX	3981
SR 50 H2O (RLA)	50	00 -	BPR8HS	3725	0,6				BPR8HIX	6742
SR 50 i.e. LC (RLB) (DiTech)	50	07.00 -	CPR8E	7411	0,6					
SR 50 i.e.LC (RLE) E2 (DiTech)	50	01 -	CPR8E	7411	0,6					
SR 50 WWW - Netscaper	50	01.97 -	BR8HS	4322	0,6	BR8HVX	6265	212	BR8HIX	7001
SR 50 AC (LY)	50	93 -	BR7HS	4122	0,5			211	BR7HIX	7067
SR 50 LC (MZA)	50	93 -	BR8HS	4322	0,5	BR8HVX	6265	212	BR8HIX	7001
SR 50 R (VFD)	50	05 -	BR9ES	5722	0,6	BR9EVX	1265	208	BR9EIX	3981
Scarabeo 100 (RE) 2T	100	00 -	BR8HS	4322	0,7	BR8HVX	6265	212	BR8HIX	7001
Scarabeo 100 (SA) 4T	100	00 -	CR7E	4578	0,7			225	CR7EIX	7385
Atlantic 125 (SP)	125	03 -	CR8EB	7784	0,6	CR8EVX	6487		CR8EIX	4218
Habana 125 (PM)	125	99 -	CR7E	4578	0,7			225	CR7EIX	7385
Leonardo 125 (MBA)	125	01.95 -	CR8E	1275	0,7	CR8EVX	6487	226	CR8EIX	4218
Leonardo 125 (TB)	125	01.95 -	CR8E	1275	0,7	CR8EVX	6487	226	CR8EIX	4218
Leonardo 125 (MB)	125	01.95 -	CR8E	1275	0,7	CR8EVX	6487	226	CR8EIX	4218
Mojito 125 (PM/RY)	125	05 -	CR7E	4578	0,7			225	CR7EIX	7385
Scarabeo 125 (PC)	125	99 -	CR8E	1275	0,6	CR8EVX	6487	226	CR8EIX	4218
Scarabeo 125 (PCA)	125	99 -	CR8E	1275	0,6	CR8EVX	6487	226	CR8EIX	4218
Sportcity 125 (VB)	125		CR7EB	4663	0,6				CR7EIX	7385
SR 125 AC (PX)	125	99 -	BR8ES	5422	0,6	BR8EVX	1262	207	BR8EIX	5044
Leonardo 150 (MBA)	150	01.97 - 00	CR8E	1275	0,7	CR8EVX	6487	226	CR8EIX	4218

					Order No.		Platin 	Order No.	Quick-No. 	Iridium	Order No.
APRILIA											
Leonardo 150 (TB)	150	01.97 - 00	CR8E	1275	0,7	CR8EVX	6487	226	CR8EIX	4218	
Leonardo 150	150	02 -	DR8EA	7162	0,6	DR8EVX	6354		DR8EIX	6681	
Leonardo 150 (MB)	150	01.97 - 00	CR8E	1275	0,7	CR8EVX	6487	226	CR8EIX	4218	
Scarabeo 150 (PC)	150	99 -	CR8E	1275	0,6	CR8EVX	6487	226	CR8EIX	4218	
Scarabeo 150 (PCA)	150	99 -	CR8E	1275	0,6	CR8EVX	6487	226	CR8EIX	4218	
SR 150	150		BR9ES	5722	0,6	BR9EVX	1265	208	BR9EIX	3981	
Atlantic 200 (SP)	200	03 -	CR8EB	7784	0,6	CR8EVX	6487		CR8EIX	4218	
Scarabeo	200	00 -	---		0,6	CR8EVX	6487		CR8EIX	4218	
Sportcity 200 (VB)	200		CR7EB	4663	0,6				CR7EIX	7385	
Atlantic 250 (SP)	250	04 -	CR8EB	7784	0,6	CR8EVX	6487		CR8EIX	4218	
Leonardo 250 (PD)	250	98 - 00	DR7EA	7839	0,6						
Leonardo 250 (SV)	250	98 - 00	DR7EA	7839	0,6						
Sportcity 250 (VB)	250	06 -	PMR7A	4259	0,6						
Leonardo 300 (PD)	300	98 - 00	DR7EA	7839	0,6						
Leonardo 300 (SV)	300	98 - 00	DR7EA	7839	0,6						
Atlantic 500 Sprint (VL)	500		CR7EKB	4455	0,6						
Atlantic 500 Sprint (PT)	500	02 -	CR7EKB	4455	0,6						
Scarabeo 500	500	02 -	CR7EKB	4455	0,6						
ATALA											
Byte	50		B7HS	5110	0,6	B7HVX	7836	204	BR7HIX	7067	
Byte 25	50	96 -	BPR6HS	7022	0,6	BPR6HVX	2740	214	BPR6HIX	4085	
Byte 50	50	96 -	BPR6HS	7022	0,6	BPR6HVX	2740	214	BPR6HIX	4085	
Carosello	50		B7HS	5110	0,6	B7HVX	7836	204	BR7HIX	7067	
Hacker - Hacker Racing	50		BPR6HS	7022	0,6	BPR6HVX	2740	214	BPR6HIX	4085	
Hacker AT12 Racing LC	50	96 -	BPR6HS	7022	0,5	BPR6HVX	2740	214	BPR6HIX	4085	
Hacker AT12 Racing	50	96 -	BPR6HS	7022	0,5	BPR6HVX	2740	214	BPR6HIX	4085	
Hacker AT12	50	96 -	BPR6HS	7022	0,5	BPR6HVX	2740	214	BPR6HIX	4085	
Master LF	50	96 -	B6HS	4510	0,5	B6HVX	7435	203	BR6HIX	3419	
Racing	50	96 -	BPR6HS	7022	0,5	BPR6HVX	2740	214	BPR6HIX	4085	
Skeggia	50	01.98 -	BPR6HS	7022	0,6	BPR6HVX	2740	214	BPR6HIX	4085	
BAJAJ											
Spirit	50	99 -	B6HS	4510	0,5	B6HVX	7435	203	BR6HIX	3419	
Sunny 50	50	97 -	B6HS	4510	0,5	B6HVX	7435	203	BR6HIX	3419	
Chetak	125		BP5HS	4111	0,6						
Chetak 125 Electr.	125		BP6HS	4511	0,6	BP6HVX	4635		BPR6HIX	4085	
Chetak 125 electr.; D	125		BP6HS	4511	0,6	BP6HVX	4635		BPR6HIX	4085	
Chetak 125 Electr.D	125		BP6HS	4511	0,6	BP6HVX	4635		BPR6HIX	4085	
Chetak	150		BP5HS	4111	0,6						
Chetak 150 Classic	150		BPR5HS	6222	0,6						
Chetak 150 Classic Green	150		BPR5HS	6222	0,6						
Chetak 150 Classic Sidec	150		BPR5HS	6222	0,6						
Chetak 150 Electr.	150		BPR5HS	6222	0,6						
Chetak 150 electr.; D; Classic;	150		BPR5HS	6222	0,6						
Sidec; Green											
Chetak 150 Electr.D	150		BPR5HS	6222	0,6						
BENELLI											
491 Superbike watercooler	50	99 -	BR7HS	4122	0,6				211	BR7HIX	7067
491 Racing watercooler	50	97 -	BR7HS	4122	0,6				211	BR7HIX	7067
491 GT aircooler	50	97 -	BR7HS	4122	0,6				211	BR7HIX	7067

						Order No.		Platin 	Order No.	Quick-No.	Iridium 	Order No.
BENELLI												
491 Sport watercooler	50	97 -	BR7HS	4122	0,6				211	BR7HIX	7067	
491 SBK	50	00 -	BR8HS	4322	0,7	BR8HVX	6265	212	BR8HIX	7001		
491 Rage ST	50	00 -	BR8HS	4322	0,7	BR8HVX	6265	212	BR8HIX	7001		
491 ST GP	50	00 -	BR8HS	4322	0,7	BR8HVX	6265	212	BR8HIX	7001		
491 GP-SP	50	99 -	BR7HS	4122	0,7			211	BR7HIX	7067		
491 GP-RR	50	99 -	BR7HS	4122	0,7			211	BR7HIX	7067		
491 only Italian	50		BR8ES	5422	0,6	BR8EVX	1262	207	BR8EIX	5044		
K2 air cool	50		BR7HS	4122	0,6			211	BR7HIX	7067		
K2 liquid cool/watercooler	50		BR7HS	4122	0,6			211	BR7HIX	7067		
K2 Namur	50	00 -	BR8HS	4322	0,7	BR8HVX	6265	212	BR8HIX	7001		
Laser 50	50		B6HS	4510	0,5	B6HVX	7435	203	BR6HIX	3419		
Naked 50	50		BR8HS	4322	0,6	BR8HVX	6265	212	BR8HIX	7001		
Pepe	50	99 -	BR7HS	4122	0,6			211	BR7HIX	7067		
Pepe Kat	50	99 -	BR8HS	4322	0,6	BR8HVX	6265	212	BR8HIX	7001		
S 50	50		B6HS	4510	0,5	B6HVX	7435	203	BR6HIX	3419		
Scoothy 50	50		B6HS	4510	0,6	B6HVX	7435	203	BR6HIX	3419		
K2 100	100	99 -	BR8HS	4322	0,7	BR8HVX	6265	212	BR8HIX	7001		
Adiva 125	125		CR8EB	7784	0,6	CR8EVX	6487		CR8EIX	4218		
Velvet Eco 125	125	99 -	CR8E	1275	0,6	CR8EVX	6487	226	CR8EIX	4218		
Adiva 150	150		CR8EB	7784	0,6	CR8EVX	6487		CR8EIX	4218		
Velvet Eco 150	150	99 -	CR8E	1275	0,6	CR8EVX	6487	226	CR8EIX	4218		
Velvet Eco 250	250	00 -	DR8EA	7162	0,7	DR8EVX	6354		DR8EIX	6681		
Dusk 400	400	05 -	CR9E	6263	0,7	CR9EVX	5943	227	CR9EIX	3521		
BETA												
Ark 50 K Serie	50		BR8HS	4322	0,6	BR8HVX	6265	212	BR8HIX	7001		
Ark Limited LC	50		BR8HS	4322	0,6	BR8HVX	6265	212	BR8HIX	7001		
Ark LC	50		BR8HS	4322	0,6	BR8HVX	6265	212	BR8HIX	7001		
Ark aircooler	50	97 -	BR7HS	4122	0,6			211	BR7HIX	7067		
Ark X Type	50		BR8HS	4322	0,6	BR8HVX	6265	212	BR8HIX	7001		
Ark watercooler	50	97 -	BR8HS	4322	0,6	BR8HVX	6265	212	BR8HIX	7001		
Ark 50 RR	50		BR8HS	4322	0,6	BR8HVX	6265	212	BR8HIX	7001		
Chrono 50	50	95 -	BR7HS	4122	0,5			211	BR7HIX	7067		
Chrono 502	50	95 -	BR7HS	4122	0,5			211	BR7HIX	7067		
Eikon	50	98 -	BR8HS	4322	0,6	BR8HVX	6265	212	BR8HIX	7001		
Quadra 50	50	95 -	BR7HS	4122	0,6			211	BR7HIX	7067		
Tempo 50	50	94 -	BR7HS	4122	0,5			211	BR7HIX	7067		
Tempo 50 13"	50	96 -	BR7HS	4122	0,5			211	BR7HIX	7067		
Tempo 50 16"	50	96 -	BR7HS	4122	0,5			211	BR7HIX	7067		
Alp 125	125		DR8EA	7162	0,6	DR8EVX	6354		DR8EIX	6681		
Alp 4T 200	125		DR8EA	7162	0,6	DR8EVX	6354		DR8EIX	6681		
Eikon 125	125	99 -	DR8EA	7162	0,6	DR8EVX	6354		DR8EIX	6681		
Eikon 150	250	99 -	DPR7EA-9	5129	0,9	DPR7EVX-9	7682	220	DPR7EIX-9	7803		
REV-3	250		BP7ES	2412	0,6	BP7EVX	7270	206	BPR7EIX	4055		
BMW												
C1 125 4T	125	04.00 - 03	CR8EB	7784	0,6	CR8EVX	6487		CR8EIX	4218		
C1 200 4T	180	00 - 03	CR8EB	7784	0,6	CR8EVX	6487		CR8EIX	4218		
BS VILLA												
Giorno	50		BR8HSA	5539	0,6	BR8HVX	6265		BR8HIX	7001		
GP Dio	50	90 -	BPR8HS	3725	0,6				BPR8HIX	6742		

					Order No.		Platin 	Order No.	Quick-No.	Iridium 	Order No.
BS VILLA											
SP Dio	50		BPR7HS	6422	0,6	BPR7HVX	2938	215	BPR7HIX	5944	
Z5	50	93 -	BR8HSA	5539	0,6	BR8HVX	6265		BR8HIX	7001	
ZX	50	93 -	BR8HSA	5539	0,6	BR8HVX	6265		BR8HIX	7001	
BUFFALO											
CY 25	50	97 -	BR7HS	4122	0,6			211	BR7HIX	7067	
CY 50	50	97 -	BR7HS	4122	0,6			211	BR7HIX	7067	
CY 50 aircooled	50	96 -	BR7HS	4122	0,6			211	BR7HIX	7067	
MK 50	50	96 -	BP7HS	5111	0,6	BP7HVX	7468		BPR7HIX	5944	
MM 50	50	97 -	BR7HS	4122	0,6			211	BR7HIX	7067	
MY 50 aircooled	50	96 -	BR7HS	4122	0,6			211	BR7HIX	7067	
Silver watercooled	50	96 -	BR8ES	5422	0,5	BR8EVX	1262	207	BR8EIX	5044	
CAGIVA											
City	50	98 -	BR8HSA	5539	0,5	BR8HVX	6265		BR8HIX	7001	
City	50	93 -	B7HS	5110	0,5	B7HVX	7836	204	BR7HIX	7067	
City	50	94 - 97	BPR8HS	3725	0,6				BPR8HIX	6742	
City L.E.	50	93 -	B7HS	5110	0,5	B7HVX	7836	204	BR7HIX	7067	
City, City LE	50	01.93 -	B7HS	5110	0,6	B7HVX	7836	204	BR7HIX	7067	
Cucciolo	50		B8HS	5510	0,6	B8HVX	2634	205	BR8HIX	7001	
Mantis	50	99 -	B9ES	2611	0,6	B9EVX	7254	202	BR9EIX	3981	
Passing	50		BP6HS	4511	0,6	BP6HVX	4635		BPR6HIX	4085	
Progress 50	50		B8HS	5510	0,6	B8HVX	2634	205	BR8HIX	7001	
Progress Corsa	50		B9ES	2611	0,6	B9EVX	7254	202	BR9EIX	3981	
Scooter	50	93 -	BR8HSA	5539	0,7	BR8HVX	6265		BR8HIX	7001	
Cucciolo	125	99 -	CR7E	4578	0,7			225	CR7EIX	7385	
Nuvola	125		CR7E	4578	0,7			225	CR7EIX	7385	
Passing	125	94 -	BP6HS	4511	0,6	BP6HVX	4635		BPR6HIX	4085	
Passing	125	95 -	BP6HS	4511	0,6	BP6HVX	4635		BPR6HIX	4085	
CAPRI											
Roller 50	50		B7ES	1111	0,5	B7EVX	6934				
Roller 50S	50		B8ES	2411	0,5	B8EVX	7051	201	BR8EIX	5044	
Roller 125	125		B8HS	5510	0,6	B8HVX	2634	205	BR8HIX	7001	
CCF											
Adly 50	50	96 -	BP7HS	5111	0,6	BP7HVX	7468		BPR7HIX	5944	
Cat 50	50	97 -	BP7HS	5111	0,6	BP7HVX	7468		BPR7HIX	5944	
Adly 100	100	96 -	BP7HS	5111	0,6	BP7HVX	7468		BPR7HIX	5944	
Cat 125	125	98 -	CR7HSA	4549	0,6				CR7HIX	7544	
CPI											
Aragon 50	50	06.06 -	BR7ES	5122	0,8	BR7EVX	4556				
Aragon Sport	50	06.06 -	BR7ES	5122	0,8	BR7EVX	4556				
Bingo FL	50	02 - 02	BR8HSA	5539	0,6	BR8HVX	6265		BR8HIX	7001	
GTR 50	50	03 -	BR7ES	5122	0,8	BR7EVX	4556				
GTS 50	50	03 -	BR7ES	5122	0,8	BR7EVX	4556				
Hussar FL	50	02 - 02	BR8HSA	5539	0,6	BR8HVX	6265		BR8HIX	7001	
Hussar SL	50	02 - 02	BR8HSA	5539	0,6	BR8HVX	6265		BR8HIX	7001	
Hussar Euro 2	50	03 -	BR7ES	5122	0,8	BR7EVX	4556				
Hussar	50	01 - 01	BR8HSA	5539	0,6	BR8HVX	6265		BR8HIX	7001	
Oliver City	50	06 -	BR7ES	5122	0,8	BR7EVX	4556				

					Order No.		Platin 	Order No.	Quick-No.	Iridium 	Order No.
CPI											
Oliver Sport	50	06 -	BR7ES	5122	0,8	BR7EVX	4556				
Oliver 50	50	03 -	BR7ES	5122	0,8	BR7EVX	4556				
Popcorn SL	50	02 - 02	BR8HSA	5539	0,6	BR8HVX	6265			BR8HIX	7001
Popcorn FL	50	02 - 02	BR8HSA	5539	0,6	BR8HVX	6265			BR8HIX	7001
Popcorn	50	00 - 01	BR8HSA	5539	0,6	BR8HVX	6265			BR8HIX	7001
Popcorn Euro 2	50	03 -	BR7ES	5122	0,8	BR7EVX	4556				
Tennessee	50	01 -	BR8HSA	5539	0,6	BR8HVX	6265			BR8HIX	7001
GTS 125	125	03 -	BR7ES	5122	0,8	BR7EVX	4556				
X-Large 125	125	03 -	BR7ES	5122	0,8	BR7EVX	4556				
GTS 150	150	03 -	BR7ES	5122	0,8	BR7EVX	4556				
X-Large 150	150	03 -	BR7ES	5122	0,8	BR7EVX	4556				
GTS 200	200	03 -	BR7ES	5122	0,8	BR7EVX	4556				
X-Large 200	200	03 -	BR7ES	5122	0,8	BR7EVX	4556				
DAELIM											
Cordi 50	50	04 -	BPR6HS	7022	0,6	BPR6HVX	2740	214		BPR6HIX	4085
E-Five	50	03 -	B8HS	5510	0,6	B8HVX	2634	205		BR8HIX	7001
Message	50	98 -	BR8HSA	5539	0,6	BR8HVX	6265			BR8HIX	7001
S-Five	50	02 -	B8HS	5510	0,6	B8HVX	2634	205		BR8HIX	7001
Tapo	50	98 -	BR8HSA	5539	0,6	BR8HVX	6265			BR8HIX	7001
Altino	100	98 -	CR8EH-9	5666	0,9	CR8EHVX-9	4546	228		CR8EHIX-9	3797
Defino	100		BR8HS	4322	0,6	BR8HVX	6265	212		BR8HIX	7001
Citi Ace 110	110	03 -	C7HSA	4629	0,7	C7HVX	4533			CR7HIX	7544
Advance	125	97 -	CR8EH-9	5666	0,9	CR8EHVX-9	4546	228		CR8EHIX-9	3797
Classic	125	00 -	CR8EH-9	5666	0,9	CR8EHVX-9	4546	228		CR8EHIX-9	3797
Daystar	125	00 -	CR8EH-9	5666	0,9	CR8EHVX-9	4546	228		CR8EHIX-9	3797
Evolution	125	97 -	CR8EH-9	5666	0,9	CR8EHVX-9	4546	228		CR8EHIX-9	3797
Fellow	125	98 - 99	CR8EH-9	5666	0,9	CR8EHVX-9	4546	228		CR8EHIX-9	3797
Freewing 125	125	05 -	CR8EH-9	5666	0,9	CR8EHVX-9	4546	228		CR8EHIX-9	3797
NS 125	125	98 -	CR8EH-9	5666	0,9	CR8EHVX-9	4546	228		CR8EHIX-9	3797
Otello	125	04 -	CR8EH-9	5666	0,9	CR8EHVX-9	4546	228		CR8EHIX-9	3797
Othello	125	98 -	CR8EH-9	5666	0,9	CR8EHVX-9	4546	228		CR8EHIX-9	3797
S-2 (Freewing)	125	05 - 06	CR8EH-9	5666	0,9	CR8EHVX-9	4546	228		CR8EHIX-9	3797
SL History 125	125		CR8EH-9	5666	0,9	CR8EHVX-9	4546	228		CR8EHIX-9	3797
VC 125	125	97 -	CR8EH-9	5666	0,9	CR8EHVX-9	4546	228		CR8EHIX-9	3797
VS 125	125	97 -	CR8EH-9	5666	0,9	CR8EHVX-9	4546	228		CR8EHIX-9	3797
DERBI											
Atlantis LC	50		B9ES	2611	0,6	B9EVX	7254	202		BR9EIX	3981
Atlantis O2	50	99 -	B8HS	5510	0,6	B8HVX	2634	205		BR8HIX	7001
Atlantis Air	50	03 -	BR9ES	5722	0,6	BR9EVX	1265	208		BR9EIX	3981
Atlantis City	50	03 -	BR9ES	5722	0,6	BR9EVX	1265	208		BR9EIX	3981
Aventura	50	95 -	B8HS	5510	0,6	B8HVX	2634	205		BR8HIX	7001
Bullet	50	03 -	BR9ES	5722	0,6	BR9EVX	1265	208		BR9EIX	3981
Furax 50	50	95 -	B8HS	5510	0,5	B8HVX	2634	205		BR8HIX	7001
GP Serie Air Cool	50		BR10ES	4832	0,6	BR10EVX	3788			BR10EIX	6801
GP1 Replica water Cool	50	93 -	BR10ES	4832	0,6	BR10EVX	3788			BR10EIX	6801
Hunter	50		B8HS	5510	0,6	B8HVX	2634	205		BR8HIX	7001
Manhattan	50		B8HS	5510	0,6	B8HVX	2634	205		BR8HIX	7001
Paddock LC	50		B9ES	2611	0,6	B9EVX	7254	202		BR9EIX	3981
Paddock 50 O2	50		B8HS	5510	0,6	B8HVX	2634	205		BR8HIX	7001
Predator LC	50	98 -	B9ES	2611	0,6	B9EVX	7254	202		BR9EIX	3981

					Order No.		Platin 	Order No.	Quick-No.	Iridium 	Order No.
DERBI											
Predator 02	50	98 -	B9ES	2611	0,6	B9EVX	7254	202		BR9EIX	3981
Predator 02 (ES)	50		B8HS	5510	0,6	B8HVX	2634	205		BR8HIX	7001
Racing Replica	50	02 -	BR9ES	5722	0,6	BR9EVX	1265	208		BR9EIX	3981
Rambra 50	50		BR9ES	5722	0,6	BR9EVX	1265	208		BR9EIX	3981
Red Bullet	50	03 -	BR9ES	5722	0,6	BR9EVX	1265	208		BR9EIX	3981
Vamos FL 50	50		BR8HS	4322	0,6	BR8HVX	6265	212		BR8HIX	7001
Vamos SE 50	50		BR8HS	4322	0,6	BR8HVX	6265	212		BR8HIX	7001
Vamos 50	50	93 -	B8HS	5510	0,5	B8HVX	2634	205		BR8HIX	7001
Variant Revolution	50	03 -	B8HS	5510	0,6	B8HVX	2634	205		BR8HIX	7001
Atlantis 100	100		B9ES	2611	0,6	B9EVX	7254	202		BR9EIX	3981
Boulevard 125 4T air cooler	125		CR9E	6263	0,7	CR9EVX	5943	227		CR9EIX	3521
Rambra 125	125		BR9ES	5722	0,6	BR9EVX	1265	208		BR9EIX	3981
Boulevard 150 4T	150		CR9E	6263	0,7	CR9EVX	5943	227		CR9EIX	3521
DÜRRKOPP											
Diana			B7HS	5110	0,5	B7HVX	7836	204		BR7HIX	7067
Diana TS	175		B8HS	5510	0,5	B8HVX	2634	205		BR8HIX	7001
ENDRESS											
EMR 50 DJ	50	97 -	BR8HSA	5539	0,6	BR8HVX	6265			BR8HIX	7001
EMR 50 Ergon	50	97 -	BP6HS	4511	0,6	BP6HVX	4635			BPR6HIX	4085
ENDRESS EMR											
EMR 50	50		BR8HSA	5539	0,6	BR8HVX	6265			BR8HIX	7001
ENFIELD											
Scooter	125		B6HS	4510	0,5	B6HVX	7435	203		BR6HIX	3419
ERING											
Cat 50	50		B6HS	4510	0,6	B6HVX	7435	203		BR6HIX	3419
Jet 50	50		B6HS	4510	0,6	B6HVX	7435	203		BR6HIX	3419
Rapido	50		B6HS	4510	0,6	B6HVX	7435	203		BR6HIX	3419
Silver Fox	50		B6HS	4510	0,6	B6HVX	7435	203		BR6HIX	3419
Sprint 50	50		C7HSA	4629	0,7	C7HVX	4533			CR7HIX	7544
Thunderbike 50	50		B6HS	4510	0,6	B6HVX	7435	203		BR6HIX	3419
Cat 125	125		CR7HSA	4549	0,6					CR7HIX	7544
Shining 125	125		CR7HSA	4549	0,6					CR7HIX	7544
Thunderbike 125	125		CR7HSA	4549	0,6					CR7HIX	7544
FAMEL-ZÜNDAPP											
Yuppie, XF	50		B8ES	2411	0,6	B8EVX	7051	201		BR8EIX	5044
FANTIC											
Grinta	50		BP7HS	5111	0,6	BP7HVX	7468			BPR7HIX	5944
Queenie	50		BP7HS	5111	0,6	BP7HVX	7468			BPR7HIX	5944
Koala,Oasis	75		B8ES	2411	0,5	B8EVX	7051	201		BR8EIX	5044
Caballero RC80	80		---		0,6	B10EG	3630				
GARELLI											
GS-1			BR8HSA	5539	0,6	BR8HVX	6265			BR8HIX	7001
XM-1			BR8HSA	5539	0,6	BR8HVX	6265			BR8HIX	7001
303 50	50		BPR7HS	6422	0,6	BPR7HVX	2938	215		BPR7HIX	5944



Order No.



Gold-Palladium



Platin

Order No.

Quick-No.

Iridium









Order No.







GARELLI







Astro 50	50		BR9HS	4522	0,6						
Astro 50 2001	50	01 -	BR9HS	4522	0,6						
Big Whell	50	93 -	BPR7HS	6422	0,6	BPR7HVX	2938	215	BPR7HIX	5944	
Flo 50	50		BPR7HS	6422	0,6	BPR7HVX	2938	215	BPR7HIX	5944	
FX 50	50		BR9HS	4522	0,6						
Grinta 50	50	01.93 -	BP7HS	5111	0,6	BP7HVX	7468		BPR7HIX	5944	
Hussar 50	50		BR8HSA	5539	0,6	BR8HVX	6265		BR8HIX	7001	
KRC 50	50		BR9HS	4522	0,6						
KRS 50	50		BR9HS	4522	0,6						
M 901 50	50		BR9HS	4522	0,6						
Mars 50	50		BR9HS	4522	0,6						
Match 50	50		BR8HSA	5539	0,6	BR8HVX	6265		BR8HIX	7001	
PMX Rally 50	50		BPR7HS	6422	0,6	BPR7HVX	2938	215	BPR7HIX	5944	
PMX Sport 50	50		BPR7HS	6422	0,6	BPR7HVX	2938	215	BPR7HIX	5944	
Pony 50	50		BP7HS	5111	0,6	BP7HVX	7468		BPR7HIX	5944	
Queenie 50	50	01.92 -	BP7HS	5111	0,6	BP7HVX	7468		BPR7HIX	5944	
Racing SR / Racing	50	- 93	BP7HS	5111	0,6	BP7HVX	7468		BPR7HIX	5944	
Raider 50	50		BR9HS	4522	0,6						
Roadshow 50	50		BR9HS	4522	0,6						
RZ1 50	50		BR9HS	4522	0,6						
Shark 50	50		BR9HS	4522	0,6						
SR	50		BP7HS	5111	0,6	BP7HVX	7468		BPR7HIX	5944	
Starter 50	50		BR9HS	4522	0,6						
PMX Sport	106		BR8HS	4322	0,6	BR8HVX	6265	212	BR8HIX	7001	
PMX Sport 110	110		BPR6HS	7022	0,6	BPR6HVX	2740	214	BPR6HIX	4085	
303 R 125	125		CR7HSA	4549	0,5				CR7HIX	7544	
Blast 125	125		CR7HSA	4549	0,5				CR7HIX	7544	
GTA 125 / ES	125		B10ES	7928	0,5	B10EGV	5927		BR10EIX	6801	
Hussar 125	125		CR7HSA	4549	0,6				CR7HIX	7544	
Hussar 125 2001	125	01 -	CR7HSA	4549	0,6				CR7HIX	7544	
Joker 125	125	03 -	CR7HSA	4549	0,7				CR7HIX	7544	
Tiger 125 XLE	125		B10ES	7928	0,5	B10EGV	5927		BR10EIX	6801	
T-Rex 125	125		CR7HSA	4549	0,6				CR7HIX	7544	
T-Rex 150 2001	125		CR7HSA	4549	0,5				CR7HIX	7544	
Freeland 150	150		CR7HSA	4549	0,7				CR7HIX	7544	
Joker 150	150		CR7HSA	4549	0,7				CR7HIX	7544	
T-Rex 150	150		CR7HSA	4549	0,5				CR7HIX	7544	
T-Rex 150 2001	150	01 -	CR7HSA	4549	0,6				CR7HIX	7544	







GILERA







DNA 50	50	00 -	BR9ES	5722	0,6	BR9EVX	1265	208	BR9EIX	3981	
Eaglet 50	50	01.93 -	B9ES	2611	0,6	B9EVX	7254	202	BR9EIX	3981	
Easy Mooving	50	01.95 -	B9ES	2611	0,6	B9EVX	7254	202	BR9EIX	3981	
GSM 50	50	00 -	BR9ES	5722	0,6	BR9EVX	1265	208	BR9EIX	3981	
Ice	50	00 -	BR9ES	5722	0,6	BR9EVX	1265	208	BR9EIX	3981	
Pure Jet 50	50	04 -	CPR8E	7411	0,6						
Runner	50	97 -	B9EG	3530	0,6	B9EGV	5827		BR9EIX	3981	
Runner 2P 2D	50	01.97 -	B9ES	2611	0,6	B9EVX	7254	202	BR9EIX	3981	
Runner SP	50	00 -	BR9ES	5722	0,6	BR9EVX	1265	208	BR9EIX	3981	
Runner (DiTech)(PIAGGIO Motor)	50	05 -	CPR8E	7411	0,6						
Runner Racing Replica	50	04 -	BR9ES	5722	0,6	BR9EVX	1265	208	BR9EIX	3981	
Stalker	50	01.97 -	B9ES	2611	0,6	B9EVX	7254	202	BR9EIX	3981	

					Order No.		Platin 	Order No.	Quick-No. 	Iridium	Order No.
GILERA											
Storm 50		50	94 -	B9ES	2611	0,5	B9EVX	7254	202	BR9EIX	3981
Typhoon 50		50	01.93 -	B9ES	2611	0,6	B9EVX	7254	202	BR9EIX	3981
Typhoon 50 Martini Racing		50	01.95 -	B9ES	2611	0,6	B9EVX	7254	202	BR9EIX	3981
Typhoon Benetton F1		50	01.96 -	B9ES	2611	0,6	B9EVX	7254	202	BR9EIX	3981
Cougar 125		125	00 -	DPR8EA-9	4929	0,9	DPR8EVX-9	2872	221	DPR8EIX-9	2202
DNA 125		125	00 -	CR8EB	7784	0,7	CR8EVX	6487		CR8EIX	4218
Runner VX 125		125	06 -	CR8EB	7784	0,7	CR8EVX	6487		CR8EIX	4218
Runner RST 125		125	05 -	CR8EB	7784	0,7	CR8EVX	6487		CR8EIX	4218
Runner FX 125		125	97 -	B9ES	2611	0,6	B9EVX	7254	202	BR9EIX	3981
Typhoon 125		125	01.95 -	B9ES	2611	0,6	B9EVX	7254	202	BR9EIX	3981
Runner		150	98 -	BR9ES	5722	0,6	BR9EVX	1265	208	BR9EIX	3981
DNA 180		180	00 -	CR8EB	7784	0,7	CR8EVX	6487		CR8EIX	4218
Runner VXR		180	01 -	CR9EB	6955	0,6				CR9EIX	3521
Runner FRX 180		180	98 -	B9ES	2611	0,6	B9EVX	7254	202	BR9EIX	3981
Nexus 500		500	06.03 -	CPR8E	7411	0,6					
HEINKEL											
Tourist 150		150	01.62 -	A7	1110						
Tourist 175		175	09.60 -	B7HS	5110	0,5	B7HVX	7836	204	BR7HIX	7067
HERKULES											
BT 50 (4takt Baotian)		50	05 -	C7HSA	4629	0,7	C7HVX	4533		CR7HIX	7544
TB 50 Race		50	05 -	BPR7HS	6422	0,6	BPR7HVX	2938	215	BPR7HIX	5944
HMZ											
Cab SB50		50	96 -	BP6HS	4511	0,6	BP6HVX	4635		BPR6HIX	4085
HONDA											
Various			02.04 -	CR7HSA	4549	0,9				CR7HIX	7544
DIO 50		50	04 -	ER8EH-N	5606	0,7					
Joker SRX50T		50	97 -	BR6HSA	4296	0,5			210	BR6HIX	3419
NB 50		50		BPR6HSA	4632	0,7	BPR6HVX	2740	214	BPR6HIX	4085
NB 50 M Melody (AB07)		50	84 -	BPR6HS	7022	0,7	BPR6HVX	2740	214	BPR6HIX	4085
NH 50 Lead		50	01.87 - 88	BPR6HS	7022	0,6	BPR6HVX	2740	214	BPR6HIX	4085
NH 50 M		50	93 -	BPR6HS	7022	0,7	BPR6HVX	2740	214	BPR6HIX	4085
NH 50 MS Lead (AF01)		50	85 - 87	BPR6HS	7022	0,7	BPR6HVX	2740	214	BPR6HIX	4085
PK 50 Wallaro		50	90 -	BR6HSA	4296	0,6			210	BR6HIX	3419
PX 50		50	89 - 90	BPR5HS	6222	0,6					
SA 50 Vision		50	01.88 - 90	BPR6HSA	4632	0,6	BPR6HVX	2740	214	BPR6HIX	4085
SA 50 Vision		50	91 -	BPR6HSA	4632	0,6	BPR6HVX	2740	214	BPR6HIX	4085
SFX 50		50	95 -	BR6HSA	4296	0,6			210	BR6HIX	3419
SGX 50 Sky		50	97 -	BR6HSA	4296	0,6			210	BR6HIX	3419
SH 50 T		50	96 -	BR6HSA	4296	0,6			210	BR6HIX	3419
SH 50 New		50	01.97 -	BPR6HS	7022	0,6	BPR6HVX	2740	214	BPR6HIX	4085
SH 50 (AF40)		50	97 -	BR6HSA	4296	0,7			210	BR6HIX	3419
SH 50 P		50	01.93 - 95	BPR6HSA	4632	0,6	BPR6HVX	2740	214	BPR6HIX	4085
SH 50 (I)		50	01.87 - 96	BPR6HS	7022	0,6	BPR6HVX	2740	214	BPR6HIX	4085
Shadow 50		50	01.97 -	BR6HSA	4296	0,6			210	BR6HIX	3419
SJ 50 Bali		50		BR6HSA	4296	0,6			210	BR6HIX	3419
Sky 50 DX		50	01.96 -	BR6HSA	4296	0,6			210	BR6HIX	3419
SXR 50 W		50	98 -	BR6HSA	4296	0,6			210	BR6HIX	3419
SZX 50 X8R-S/X		50	98 -	BR6HSA	4296	0,6			210	BR6HIX	3419

					Order No.		Gold-Palladium	Platin 	Order No.	Quick-No.	Iridium 	Order No.
HONDA												
X8R-S	50	01.98 -	BR6HSA	4296	0,6					210	BR6HIX	3419
X8R-X	50	01.98 -	BR6HSA	4296	0,6					210	BR6HIX	3419
Zoomer	50	04 -	ER8EH-N	5606	0,7							
NH 80 MS Lead (HD01)	80	83 -	BPR6HS	7022	0,7	BPR6HVX	2740		214	BPR6HIX	4085	
SRX 90 Shadow (JH2 HF09A)	90	98 -	BR6HSA	4296	0,7				210	BR6HIX	3419	
SCV 100 Lead	100	03 -	CR6HSA	2983	0,7						CR6HIX	7274
SH 100 T	100	01.96 -	BR6HSA	4296	0,6				210	BR6HIX	3419	
SJ 100 Bali	100	01.96 -	BR6HSA	4296	0,6				210	BR6HIX	3419	
@ 125	125	00 -	CR8EH-9	5666	0,9	CR8EHVX-9	4546		228	CR8EHIX-9	3797	
CH 125	125	01.86 - 95	DPR7EA-9	5129	0,9	DPR7EVX-9	7682	220	DPR7EIX-9	7803		
CH 125 P	125	-01.93	DPR7EA-9	5129	0,9	DPR7EVX-9	7682	220	DPR7EIX-9	7803		
Dylan 125	125	02 -	CR8EH-9	5666	0,9	CR8EHVX-9	4546	228	CR8EIX-9	3797		
FES 125 Pantheon 4Takt	125	03 -	CR8EH-9	5666	0,9	CR8EHVX-9	4546	228	CR8EIX-9	3797		
FES 125 Pantheon (JF05) 2Takt	125	98 -	BR8ES	5422	0,7	BR8EVX	1262	207	BR8EIX	5044		
NH 125 D Lead	125	83 -	BPR6HS	7022	0,7	BPR6HVX	2740	214	BPR6HIX	4085		
Pantheon 125	125	01.98 -	BR8ES	5422	0,7	BR8EVX	1262	207	BR8EIX	5044		
SH 125	125	01 -	CR8EH-9	5666	0,9	CR8EHVX-9	4546	228	CR8EIX-9	3797		
Spacy CH 125 (JS03)	125	97 -	DPR7EA-9	5129	0,9	DPR7EVX-9	7682	220	DPR7EIX-9	7803		
SH 150i	150	06 -	CR8EH-9	5666	0,9	CR8EHVX-9	4546	228	CR8EIX-9	3797		
CN 250	250	01.86 -	DPR6EA-9	5531	0,9							
CN 250 Fusion	250		DPR8EA-9	4929	0,9	DPR8EVX-9	2872	221	DPR8EIX-9	2202		
CN 250 Helix (MF02)	250	01.87 - 99	DPR6EA-9	5531	0,9							
FES 250 Foresight (MF04)	250	97 -	DPR7EA-9	5129	0,9	DPR7EVX-9	7682	220	DPR7EIX-9	7803		
Foresight 250 (I)	250	01.98 -	DPR7EA-9	5129	0,9	DPR7EVX-9	7682	220	DPR7EIX-9	7803		
Forza	250	05 -	DPR7EA-9	5129	0,9	DPR7EVX-9	7682	220	DPR7EIX-9	7803		
Silverwing 400	400	06 -	CR8EH-9	5666	0,9	CR8EHVX-9	4546	228	CR8EIX-9	3797		
Silver Wing ABS (G2)	600	03 -	CR8EH-9	5666	0,9	CR8EHVX-9	4546	228	CR8EIX-9	3797		
Silver Wing 600	600	01 -	CR8EH-9	5666	0,9	CR8EHVX-9	4546	228	CR8EIX-9	3797		
HYOSUNG												
Avanti 50 (SD50)	50	99 -	BP6HS	4511	0,6	BP6HVX	4635				BPR6HIX	4085
Cab 50 (SB50G)	50	95 -	BP6HS	4511	0,6	BP6HVX	4635				BPR6HIX	4085
Gamma 50 (SB50G)	50	97 -	BP6HS	4511	0,6	BP6HVX	4635				BPR6HIX	4085
Prima	50		BR8HSA	5539	0,6	BR8HVX	6265				BR8HIX	7001
Sense	50		BP6HS	4511	0,6	BP6HVX	4635				BPR6HIX	4085
SF 50	50	99 -	BR8HSA	5539	0,6	BR8HVX	6265				BR8HIX	7001
SF Rally 50	50	04 -	BR8HSA	5539	0,6	BR8HVX	6265				BR8HIX	7001
Supercab (EZ100)	100	97 -	BP7HS	5111	0,6	BP7HVX	7468				BPR7HIX	5944
Boomer 125	125	02 -	DR8EA	7162	0,6	DR8EVX	6354				DR8EIX	6681
Grand Prix	125		DR8EA	7162	0,6	DR8EVX	6354				DR8EIX	6681
Plus 125	125		DR8EA	7162	0,6	DR8EVX	6354				DR8EIX	6681
ITALJET												
Ascot 50	50		BP7HS	5111	0,6	BP7HVX	7468				BPR7HIX	5944
Bazooka - Bazooka II	50		BP7HS	5111	0,6	BP7HVX	7468				BPR7HIX	5944
Cruise	50		BP6HS	4511	0,6	BP6HVX	4635				BPR6HIX	4085
Dragster	50	98 -	B7HS	5110	0,6	B7HVX	7836	204			BR7HIX	7067
Dragster 50	50	97 - 98	BPR8HS	3725	0,6						BPR8HIX	6742
Dragster 50	50	96 - 97	BPR8HS	3725	0,6						BPR8HIX	6742
Dragster 50	50	98 -	BR8HS	4322	0,6	BR8HVX	6265	212			BR8HIX	7001
Fastboy	50	98 -	BR7HS	4122	0,6				211		BR7HIX	7067
Formula 50 Mofa (aircool)	50	99 -	BR8HS	4322	0,6	BR8HVX	6265	212			BR8HIX	7001

					Order No.		Platin 	Order No.	Quick-No.	Iridium 	Order No.
ITALJET											
Formula 50 watercool	50	98 -	BR8HS	4322	0,6	BR8HVX	6265	212	BR8HIX	7001	
Formula 50	50	01.95 -	BPR6HS	7022	0,6	BPR6HVX	2740	214	BPR6HIX	4085	
Formula 50 aircool	50	98 -	BR7HS	4122	0,6			211	BR7HIX	7067	
Pista 50 ; Pista II	50		BP7HS	5111	0,6	BP7HVX	7468		BPR7HIX	5944	
Reporter	50		BP7HS	5111	0,6	BP7HVX	7468		BPR7HIX	5944	
Scoop 50	50		BP7HS	5111	0,6	BP7HVX	7468		BPR7HIX	5944	
Sunny 50	50		BP6HS	4511	0,6	BP6HVX	4635		BPR6HIX	4085	
Torpedo 2T	50		B7HS	5110	0,6	B7HVX	7836	204	BR7HIX	7067	
Torpedo 50	50	98 -	BR7HS	4122	0,6			211	BR7HIX	7067	
Torpedo 25	50	97 -	BPR8HS	3725	0,6				BPR8HIX	6742	
Torpedo 4T	50		CR7E	4578	0,6			225	CR7EIX	7385	
Velocifero	50	-	BPR6HS	7022	0,7	BPR6HVX	2740	214	BPR6HIX	4085	
Velocifero 8",10"	50	98 -	BR8HS	4322	0,6	BR8HVX	6265	212	BR8HIX	7001	
Yankee 50	50		BP7HS	5111	0,6	BP7HVX	7468		BPR7HIX	5944	
Millenium 100	100		BR7HS	4122	0,6			211	BR7HIX	7067	
Dragster 125	125	98 -	BR9ES	5722	0,6	BR9EVX	1265	208	BR9EIX	3981	
Dragster 125	125	97 - 97	B7HS	5110	0,6	B7HVX	7836	204	BR7HIX	7067	
Formula 125	125	98 -	BR8HS	4322	0,6	BR8HVX	6265	212	BR8HIX	7001	
Formula 125	125	97 - 98	B7HS	5110	0,6	B7HVX	7836	204	BR7HIX	7067	
Formula 125 (I)	125		BR7HS	4122	0,6			211	BR7HIX	7067	
Jet Set	125		CR7E	4578	0,6			225	CR7EIX	7385	
Jupiter	125		CR8E	1275	0,7	CR8EVX	6487	226	CR8EIX	4218	
Millenium	125	99 -	CR8E	1275	0,7	CR8EVX	6487	226	CR8EIX	4218	
Torpedo 125 4T	125	98 -	CR7E	4578	0,7			225	CR7EIX	7385	
Jet Set	150		CR7E	4578	0,6			225	CR7EIX	7385	
Jupiter	150		CR8E	1275	0,7	CR8EVX	6487	226	CR8EIX	4218	
Millenium	150		CR8E	1275	0,7	CR8EVX	6487	226	CR8EIX	4218	
Dragster 180	180	98 -	BR9ES	5722	0,6	BR9EVX	1265	208	BR9EIX	3981	
Jupiter	250		DR8EA	7162	0,6	DR8EVX	6354		DR8EIX	6681	
Millenium	250	99 -	DR8EA	7162	0,6	DR8EVX	6354		DR8EIX	6681	
ITTECO											
Hornet	50		BP6HS	4511	0,6	BP6HVX	4635		BPR6HIX	4085	
KINETIC											
Pride	50		BP7HS	5111	0,6	BP7HVX	7468		BPR7HIX	5944	
Pride	80		BP7HS	5111	0,6	BP7HVX	7468		BPR7HIX	5944	
KREIDLER											
Florett RMC 25	50	05 -	BPR7HS	6422	0,6	BPR7HVX	2938	215	BPR7HIX	5944	
Florett RMC 50	50	05 -	BPR7HS	6422	0,6	BPR7HVX	2938	215	BPR7HIX	5944	
Florett XL 25	50		BPR7HS	6422	0,6	BPR7HVX	2938	215	BPR7HIX	5944	
Florett 25	50	01.96 -	BPR7HS	6422	0,6	BPR7HVX	2938	215	BPR7HIX	5944	
Florett 50	50	01.96 -	BPR7HS	6422	0,6	BPR7HVX	2938	215	BPR7HIX	5944	
Florett XL 50	50		BPR7HS	6422	0,6	BPR7HVX	2938	215	BPR7HIX	5944	
Flory RC 25	50	05 -	BPR7HS	6422	0,6	BPR7HVX	2938	215	BPR7HIX	5944	
Flory 50	50	96 -	BPR7HS	6422	0,6	BPR7HVX	2938	215	BPR7HIX	5944	
Flory RC 50	50	05 -	BPR7HS	6422	0,6	BPR7HVX	2938	215	BPR7HIX	5944	
Flory 25	50	96 -	BPR7HS	6422	0,6	BPR7HVX	2938	215	BPR7HIX	5944	
MK	50	96 -	BPR7HS	6422	0,6	BPR7HVX	2938	215	BPR7HIX	5944	
Florett RMC 125	125	05 -	CR7HSA	4549	0,5				CR7HIX	7544	
Flory 125 4Takt	125		CR7HSA	4549	0,5				CR7HIX	7544	

					Order No.		Platin 	Order No.	Quick-No.	Iridium 	Order No.
KREIDLER											
Mustang	125	97 -	CR7HSA	4549	0,5					CR7HIX	7544
KTM											
Chrono 50	50		BR7HS	4122	0,5				211	BR7HIX	7067
Go 50	50		BR7HS	4122	0,5				211	BR7HIX	7067
K 50 (I)	50		BR7HS	4122	0,5				211	BR7HIX	7067
KYMCO											
Agility 50	50	05 -	CR7HSA	4549	0,5					CR7HIX	7544
Calypto 50	50	97 -	BR8HS	4322	0,6	BR8HVX	6265	212		BR8HIX	7001
Cobra Cross	50	97 -	BR8HSA	5539	0,6	BR8HVX	6265			BR8HIX	7001
Cobra Racer	50	97 -	BR8HSA	5539	0,6	BR8HVX	6265			BR8HIX	7001
CSX 50	50		BR8HSA	5539	0,6	BR8HVX	6265			BR8HIX	7001
Curio	50		BR8HSA	5539	0,6	BR8HVX	6265			BR8HIX	7001
CX 50; CX Super	50		BR8HSA	5539	0,6	BR8HVX	6265			BR8HIX	7001
Dink 50 2Takt (Italy)	50	99 -	CR7HSA	4549	0,5					CR7HIX	7544
Dink 50 LC /Bet&Win 50LC	50		BR6HSA	4296	0,6			210		BR6HIX	3419
DJ 50	50		BR8HSA	5539	0,6	BR8HVX	6265			BR8HIX	7001
DJW 50 ;W / X / Y	50	01.93 -	BR8HSA	5539	0,6	BR8HVX	6265			BR8HIX	7001
Fever II ZX 50	50		BR8HSA	5539	0,6	BR8HVX	6265			BR8HIX	7001
Fever ZX 50	50		BR8HSA	5539	0,6	BR8HVX	6265			BR8HIX	7001
Filly 50	50	98 -	C7HSA	4629	0,7	C7HVX	4533			CR7HIX	7544
Grand Dink 50 2Takt	50	05 -	BR8HSA	5539	0,6	BR8HVX	6265			BR8HIX	7001
Heroism 50	50		BR8HSA	5539	0,6	BR8HVX	6265			BR8HIX	7001
K 12 50	50		BR8HSA	5539	0,6	BR8HVX	6265			BR8HIX	7001
KB 50	50		BR8HSA	5539	0,6	BR8HVX	6265			BR8HIX	7001
People 50	50	99 -	BR8HSA	5539	0,6	BR8HVX	6265			BR8HIX	7001
Scout	50	97 -	BR8HSA	5539	0,6	BR8HVX	6265			BR8HIX	7001
Sniper 50	50	01.93 -	BR8HSA	5539	0,6	BR8HVX	6265			BR8HIX	7001
Snuper 50 DD	50		BR8HSA	5539	0,6	BR8HVX	6265			BR8HIX	7001
Spacer 50	50	99 -	BR8HSA	5539	0,6	BR8HVX	6265			BR8HIX	7001
Super 9 AC	50	01 -	BR8HSA	5539	0,6	BR8HVX	6265			BR8HIX	7001
Super 9 LC	50	01 -	BR8HSA	5539	0,6	BR8HVX	6265			BR8HIX	7001
Tomos Classic;Quadro;Flexer	50	01 -	B6HS	4510	0,6	B6HVX	7435	203		BR6HIX	3419
Top Boy 50	50	01 -	BR8HSA	5539	0,6	BR8HVX	6265			BR8HIX	7001
Vitality 50 4Takt	50	05 -	CR7HSA	4549	0,5					CR7HIX	7544
Vitality 50 2Takt	50	05 -	BR8HSA	5539	0,6	BR8HVX	6265			BR8HIX	7001
Yager 50 2Takt	50	01 -	BR8HSA	5539	0,6	BR8HVX	6265			BR8HIX	7001
YUP 50	50	00 -	BR8HSA	5539	0,6	BR8HVX	6265			BR8HIX	7001
Cobra Racer 100	100	99 -	BR8HSA	5539	0,6	BR8HVX	6265			BR8HIX	7001
Agility 125	125	05 -	CR7HSA	4549	0,7					CR7HIX	7544
Calypto 125	125	97 -	C7HSA	4629	0,6	C7HVX	4533			CR7HIX	7544
CK 125	125	05 -	DR8EA	7162	0,6	DR8EVX	6354			DR8EIX	6681
Dink 125 4Takt	125	99 -	DPR7EA-9	5129	0,9	DPR7EVX-9	7682	220		DPR7EIX-9	7803
Grand Dink 125 4Takt	125	99 -	DPR7EA-9	5129	0,9	DPR7EVX-9	7682	220		DPR7EIX-9	7803
Heroism 125	125		C7HSA	4629	0,7	C7HVX	4533			CR7HIX	7544
Hipster 125 2 Ventililer	125	01 -	DR8EA	7162	0,7	DR8EVX	6354			DR8EIX	6681
Hipster 125 4 Ventililer	125		CR8E	1275	0,7	CR8EVX	6487	226		CR8EIX	4218
Movie 125 4Takt	125		C7HSA	4629	0,6	C7HVX	4533			CR7HIX	7544
People 125	125	05 -	C7HSA	4629	0,6	C7HVX	4533			CR7HIX	7544
Pulsar 125	125	01 -	DR8EA	7162	0,7	DR8EVX	6354			DR8EIX	6681
Spacer	125	97 -	DPR7EA-9	5129	0,6	DPR7EVX-9	7682	220		DPR7EIX-9	7803

					Order No.		Gold-Palladium	Platin 	Order No.	Quick-No.	Iridium 	Order No.
KYMCO												
Spacer 125		125		DPR7EA-9	5129	0,9		DPR7EVX-9	7682	220	DPR7EIX-9	7803
Yager 125 4Takt		125	01 -	DPR7EA-9	5129	0,9		DPR7EVX-9	7682	220	DPR7EIX-9	7803
Zing		125	97 -	DR8EA	7162	0,6		DR8EVX	6354		DR8EIX	6681
Heroism		150		C7HSA	4629	0,7		C7HVX	4533		CR7HIX	7544
Dink 250 4Takt		250	99 -	DPR7EA-9	5129	0,9		DPR7EVX-9	7682	220	DPR7EIX-9	7803
Grand Dink 250 4Takt		250	99 -	DPR7EA-9	5129	0,9		DPR7EVX-9	7682	220	DPR7EIX-9	7803
People 250		250	05 -	DPR7EA-9	5129	0,9		DPR7EVX-9	7682	220	DPR7EIX-9	7803
Xciting 250		250	05 -	DPR7EA-9	5129	0,9		DPR7EVX-9	7682	220	DPR7EIX-9	7803
Xciting 500		500	05 -	CR8E	1275	0,7		CR8EVX	6487	226	CR8EIX	4218
K-ZWO												
Cat 50		50	97 -	BR7HS	4122	0,6				211	BR7HIX	7067
K-zwo VIVA 50/25		50		BR7HS	4122	0,5				211	BR7HIX	7067
Motron Sting		50		BR7HS	4122	0,5				211	BR7HIX	7067
Motron Thunder		50		BR7HS	4122	0,5				211	BR7HIX	7067
Siamoto Falkon		50		C7HSA	4629	0,6		C7HVX	4533		CR7HIX	7544
Siamoto Scross		50		C7HSA	4629	0,6		C7HVX	4533		CR7HIX	7544
K-Zwo Apache		125		D8EA	2120	0,6		D8EVX	2850	216	BR8EIX	6681
K-Zwo Royal 125		125	96 -	C7HSA	4629	0,6		C7HVX	4533		CR7HIX	7544
Royal 125		125	96 -	C7HSA	4629	0,6		C7HVX	4533		CR7HIX	7544
LECSON												
LTS 50 BW		50		BP6HS	4511	0,6		BP6HVX	4635		BPR6HIX	4085
LTS 50 TR		50		BP6HS	4511	0,6		BP6HVX	4635		BPR6HIX	4085
LEM												
Flash (I)		50		BR7HS	4122	0,6				211	BR7HIX	7067
Ghibli (I)		50		BR7HS	4122	0,6				211	BR7HIX	7067
LML - VESPA												
NV 125 SPL		125		BP8ES	2912	0,6		BP8EVX	2671			
NV 150 SPL		150		BP8ES	2912	0,6		BP8EVX	2671			
NV 200 SPL		200		B5ES	6410	0,6						
MACAL												
GTX		50	98 -	BR7HS	4122	0,6				211	BR7HIX	7067
MY 50		50	99 -	BR7HS	4122	0,6				211	BR7HIX	7067
New Star		50	98 -	BR7HS	4122	0,6				211	BR7HIX	7067
Star Flight		50	98 -	BR7HS	4122	0,6				211	BR7HIX	7067
Trophy		50	98 -	BR8ES	5422	0,6		BR8EVX	1262	207	BR8EIX	5044
MALAGUTI												
Centro SL		50	93 -	BR7HS	4122	0,5				211	BR7HIX	7067
Centro		50	00 -	BR8HS	4322	0,5		BR8HVX	6265	212	BR8HIX	7001
Centro SL 50		50		BR7HS	4122	0,6				211	BR7HIX	7067
Centro 50		50	01.92 -	BR7HS	4122	0,6				211	BR7HIX	7067
Ciak		50		BR8HS	4322	0,5		BR8HVX	6265	212	BR8HIX	7001
CR 1		50	10.95 -	BPR6HS	7022	0,5		BPR6HVX	2740	214	BPR6HIX	4085
Crosser CR1 50		50		BPR6HS	7022	0,6		BPR6HVX	2740	214	BPR6HIX	4085
ET		50		B6HS	4510	0,6		B6HVX	7435	203	BR6HIX	3419
F-10		50	93 -	BR7HS	4122	0,5				211	BR7HIX	7067
F-10 Jetline		50	00 -	BR8HS	4322	0,5		BR8HVX	6265	212	BR8HIX	7001



Order No.



Gold-Palladium



Order No.

Quick-No.

Iridium



Order No.

MALAGUTI







F-10 Jetline WAP	50	03 -	BR7HS	4122	0,6			211	BR7HIX	7067
F-10 Jet Line 50	50	01.92 -	BR7HS	4122	0,6			211	BR7HIX	7067
F-10 Jet Line Tigers 50	50		BR7HS	4122	0,6			211	BR7HIX	7067
F-11	50		BR8HS	4322	0,5	BR8HVX	6265	212	BR8HIX	7001
F-12 Phantom 3 AC	50	03 -	BR7HS	4122	0,6			211	BR7HIX	7067
F-12 Phantom AC	50	00 -	BR8HS	4322	0,5	BR8HVX	6265	212	BR8HIX	7001
F-12 Phantom	50		BR7HS	4122	0,6			211	BR7HIX	7067
F-12 Phantom LC dd	50	00 -	BR8HS	4322	0,5	BR8HVX	6265	212	BR8HIX	7001
F-12 Phantom	50		BR7HS	4122	0,5			211	BR7HIX	7067
F-12 LC	50		BR7HS	4122	0,5			211	BR7HIX	7067
F-15 Firefox 50	50	01.96 -	BR8HS	4322	0,6	BR8HVX	6265	212	BR8HIX	7001
F-15	50	97 -	BR8HS	4322	0,5	BR8HVX	6265	212	BR8HIX	7001
Grizzly RXC 12	50		BR8HS	4322	0,5	BR8HVX	6265	212	BR8HIX	7001
Grizzly RXC 10	50		BR6HS	3922	0,5			209	BR6HIX	3419
Phantom LC Tiger 50	50	01.93 -	BR7HS	4122	0,6			211	BR7HIX	7067
Yesterday	50	97 -	BR8HS	4322	0,6	BR8HVX	6265	212	BR8HIX	7001
Ciak 125 4Takt	125		CR7HSA	4549	0,7				CR7HIX	7544
Madison 125	125		CR8E	1275	0,7	CR8EVX	6487	226	CR8EIX	4218
Ciak 150 4Takt	150		CR7HSA	4549	0,7				CR7HIX	7544
F-12 Phantom Max 200	200	04 -	CR8EB	7784	0,6	CR8EVX	6487		CR8EIX	4218
Madison S 200	200	03 -	CR8EB	7784	0,6	CR8EVX	6487		CR8EIX	4218
Madison S250	250		DR8EA	7162	0,7	DR8EVX	6354		DR8EIX	6681
Madison 400	400	03 -	CR9E	6263	0,7	CR9EVX	5943	227	CR9EIX	3521
Spidermax 500 GT	500	04 -	CR7EKB	4455	0,6					







MARS







MK 50/1	50		BP6HS	4511	0,6	BP6HVX	4635		BPR6HIX	4085
SM 50	50		BP7HS	5111	0,6	BP7HVX	7468		BPR7HIX	5944
SM 50/1	50		BP7HS	5111	0,6	BP7HVX	7468		BPR7HIX	5944







MBK







Active 50 (I)	50		BR7HS	4122	0,6			211	BR7HIX	7067
Booster N.G. 50 (I)	50		BR8HS	4322	0,6	BR8HVX	6265	212	BR8HIX	7001
Booster R 50 (I)	50		BR7HS	4122	0,6			211	BR7HIX	7067
Booster Spirit 50 (I)	50		BR8HS	4322	0,6	BR8HVX	6265	212	BR8HIX	7001
Booster (4FG) (CH)	50		BR8HS	4322	0,5	BR8HVX	6265	212	BR8HIX	7001
Booster 50 (I)	50	01.90 - 94	BPR7HS	6422	0,6	BPR7HVX	2938	215	BPR7HIX	5944
Booster (CW50)	50	97 -	BR8HS	4322	0,6	BR8HVX	6265	212	BR8HIX	7001
Booster NG (CW50RSP)	50	97 -	BR8HS	4322	0,6	BR8HVX	6265	212	BR8HIX	7001
Booster	50	93 -	BR7HS	4122	0,5			211	BR7HIX	7067
Booster Rocket (CW50RSP)	50	97 -	BR8HS	4322	0,6	BR8HVX	6265	212	BR8HIX	7001
Booster Track (CW50RSX)	50	97 -	BR8HS	4322	0,6	BR8HVX	6265	212	BR8HIX	7001
Booster (3TX) (GB)	50		BPR7HS	6422	0,5	BPR7HVX	2938	215	BPR7HIX	5944
CT 50 S - CT 50 SS (I)	50		BP7HS-10	7829	0,6					
Dakota	50	05 -	BR7HS	4122	0,6			211	BR7HIX	7067
Evolis (4FW)	50	93 -	BR7HS	4122	0,5			211	BR7HIX	7067
Evolis 50 (YE50)	50	97 -	BR8HS	4322	0,6	BR8HVX	6265	212	BR8HIX	7001
Evolis 50 (I)	50	01.92 -	BR7HS	4122	0,6			211	BR7HIX	7067
Evolis (4HU) (NL)	50		BR6HS	3922	0,5			209	BR6HIX	3419
Fizz	50	- 96	BR8HS	4322	0,5	BR8HVX	6265	212	BR8HIX	7001
Fizz (YM50)	50	97 -	BR8HS	4322	0,6	BR8HVX	6265	212	BR8HIX	7001
Fizz 50 (I)	50	01.94 -	BR7HS	4122	0,6			211	BR7HIX	7067







					Order No.		Platin 	Order No.	Quick-No. 	Iridium	Order No.
MBK											
Flipper	50		BR8HS	4322	0,6	BR8HVX	6265	212	BR8HIX	7001	
Forte (3UG)	50	96 -	BR8HS	4322	0,6	BR8HVX	6265	212	BR8HIX	7001	
Forte (YA50R)	50	97 -	BR7HS	4122	0,5			211	BR7HIX	7067	
Forte 50 (I)	50	01.94 -	BR7HS	4122	0,6			211	BR7HIX	7067	
Kansas	50	05 -	BR7HS	4122	0,6			211	BR7HIX	7067	
Mach G	50		BR8HS	4322	0,6	BR8HVX	6265	212	BR8HIX	7001	
Mach G LC 50	50		BR8HS	4322	0,6	BR8HVX	6265	212	BR8HIX	7001	
New Sorriso 50 (I)	50	01.95 -	BP7HS	5111	0,6	BP7HVX	7468		BPR7HIX	5944	
Nitro F1 "Mac Laren"	50	00 -	BR8HS	4322	0,6	BR8HVX	6265	212	BR8HIX	7001	
Nitro	50	97 -	BR8HS	4322	0,6	BR8HVX	6265	212	BR8HIX	7001	
Ovetto	50	01.97 -	BR7HS	4122	0,6			211	BR7HIX	7067	
Phönix	50	05 -	BR7HS	4122	0,6			211	BR7HIX	7067	
Sorriso 50 (I)	50		BP7HS-10	7829	0,6						
Stunt 50	50	03 -	BR8HS	4322	0,6	BR8HVX	6265	212	BR8HIX	7001	
Target 50 (I)	50		BP7HS	5111	0,6	BP7HVX	7468		BPR7HIX	5944	
X-Limit	50	05 -	BR9ES	5722	0,7	BR9EVX	1265	208	BR9EIX	3981	
Evolis (4MU)(YE80)	80	96 -	BR7HS	4122	0,7			211	BR7HIX	7067	
Zest (4MU)	80		BR7HS	4122	0,7			211	BR7HIX	7067	
Nitro 100	100		BR8HS	4322	0,6	BR8HVX	6265	212	BR8HIX	7001	
Ovetto 100	100		BR8HS	4322	0,6	BR8HVX	6265	212	BR8HIX	7001	
Flame (XC125T)	125		CR7E	4578	0,6			225	CR7EIX	7385	
Flame (4NB)	125		CR7E	4578	0,6			225	CR7EIX	7385	
Flame (XC125R)	125		CR7E	4578	0,6			225	CR7EIX	7385	
Doodo 4T	125		CR8E	1275	0,7	CR8EVX	6487	226	CR8EIX	4218	
Skycruiser 125	125	06 -	CPR9EA-9								
Skyliner	125	98 -	CR8E	1275	0,7	CR8EVX	6487	226	CR8EIX	4218	
Thunder 125 4T	125		CR8E	1275	0,7	CR8EVX	6487	226	CR8EIX	4218	
XC 125 Flame (I)	125	01.95 -	CR7E	4578	0,7			225	CR7EIX	7385	
XC 125 Flame (I)	125	- 94	CR6HSA	2983	0,7				CR6HIX	7274	
Vertex 150 (I)	150		CR7E	4578	0,7			225	CR7EIX	7385	
Kilibre 300	300	03 -	DR8EA	7162	0,9	DR8EVX	6354		DR8EIX	6681	
Skyliner 400	400	04 -	CR7E	4578	0,7			225	CR7EIX	7385	
MOTOTECHNIKA											
Motoroller "Myravey"	200	73 -	BP6HS	4511	0,7	BP6HVX	4635		BPR6HIX	4085	
MOTRON											
Spike (I)	50		BR7HS	4122	0,6			211	BR7HIX	7067	
Sting 50	50	96 -	BR7HS	4122	0,6			211	BR7HIX	7067	
Sting 50 (I)	50		BR7HS	4122	0,6			211	BR7HIX	7067	
Syncro (I)	50		BR7HS	4122	0,6			211	BR7HIX	7067	
Thunder S 50 (I)	50		BR7HS	4122	0,6			211	BR7HIX	7067	
Thunder 50	50	96 -	BR7HS	4122	0,6			211	BR7HIX	7067	
MSA											
MX	50		BR8HSA	5539	0,5	BR8HVX	6265		BR8HIX	7001	
RC SM	50	99 -	BR8ES	5422	0,6	BR8EVX	1262	207	BR8EIX	5044	
RC	50	99 -	BR8ES	5422	0,6	BR8EVX	1262	207	BR8EIX	5044	
RC Trophy Yacco	50	00 -	BR8ES	5422	0,6	BR8EVX	1262	207	BR8EIX	5044	
RSE	50	99 -	BR8ES	5422	0,6	BR8EVX	1262	207	BR8EIX	5044	
RTW	50	00 -	BR8ES	5422	0,6	BR8EVX	1262	207	BR8EIX	5044	
SM	50	01 -	BR8ES	5422	0,6	BR8EVX	1262	207	BR8EIX	5044	







					Order No.		Platin 	Order No.	Quick-No.	Iridium 	Order No.
MZ											
Moskito 50 RX (EG Country)	50	02 -	BR8HSA	5539	0,6	BR8HVX	6265			BR8HIX	7001
Moskito 50RX (not EG Country)	50	02 -	BPR6HS	7022	0,6	BPR6HVX	2740	214		BPR6HIX	4085
Moskito FB 50	50	97 -	BR7HS	4122	0,6			211		BR7HIX	7067
Moskito 50 SX (CPI50C)	50	99 -	BR7HS	4122	0,6			211		BR7HIX	7067
Moskito 125	125	01 -	CR7HSA	4549	0,6					CR7HIX	7544
NSU											
Lambretta	175		B7HS	5110	0,5	B7HVX	7836	204		BR7HIX	7067
OTTO											
Fashion 50	50	96 -	BR8HSA	5539	0,6	BR8HVX	6265			BR8HIX	7001
GTX 50	50	96 -	BR7HS	4122	0,6			211		BR7HIX	7067
PEGASUS											
Corona 25	50		BPR7HS	6422	0,5	BPR7HVX	2938	215		BPR7HIX	5944
Corona 50	50		BPR7HS	6422	0,5	BPR7HVX	2938	215		BPR7HIX	5944
Skiper 25	50		BPR7HS	6422	0,5	BPR7HVX	2938	215		BPR7HIX	5944
Skiper 50	50		BPR7HS	6422	0,5	BPR7HVX	2938	215		BPR7HIX	5944
Sky 25	50		BPR7HS	6422	0,5	BPR7HVX	2938	215		BPR7HIX	5944
Sky 25 High Wheels	50		BPR7HS	6422	0,5	BPR7HVX	2938	215		BPR7HIX	5944
Sky 50	50		BPR7HS	6422	0,5	BPR7HVX	2938	215		BPR7HIX	5944
Sky 50 High Wheels	50		BPR7HS	6422	0,5	BPR7HVX	2938	215		BPR7HIX	5944
Solero 25	50		BPR7HS	6422	0,5	BPR7HVX	2938	215		BPR7HIX	5944
Solero 50	50		BPR7HS	6422	0,5	BPR7HVX	2938	215		BPR7HIX	5944
Corona 125 Sport Edition	125		CR7HSA	4549	0,6					CR7HIX	7544
Corona 125 Comfort Edition	125		CR7HSA	4549	0,6					CR7HIX	7544
Skiper 125	125		CR7HSA	4549	0,7					CR7HIX	7544
Sky 125	125		CR7HSA	4549	0,7					CR7HIX	7544
PEUGEOT											
Buxi 50; Road	50		B7HS	5110	0,6	B7HVX	7836	204		BR7HIX	7067
Buxy	50		B7HS	5110	0,6	B7HVX	7836	204		BR7HIX	7067
Eliséo 50	50	98 -	BR7HS	4122	0,7			211		BR7HIX	7067
Elystar Advantage 50	50		BR7HS	4122	0,7			211		BR7HIX	7067
Elystar TSDI 50	50		CR7EKA		0,6						
Jet Force 50 / TSDI	50	03.03 -	CR7EKA		0,6						
Jet Force C-Tech 50	50	05 -	CR7EB	4663	0,6						
Looxor Vergaser	50	01 -	BR7HS	4122	0,6			211		BR7HIX	7067
Looxor 50 TSDI	50		CPR8E	7411	0,6						
Ludix Blaster	50	04 -	BR7HS	4122	0,7			211		BR7HIX	7067
Ludix Classic	50	04 -	BR7HS	4122	0,6			211		BR7HIX	7067
Ludix Elegance	50	04 -	BR7HS	4122	0,6			211		BR7HIX	7067
Ludix One	50	04 -	BR7HS	4122	0,7			211		BR7HIX	7067
Ludix Snake	50	04 -	BR7HS	4122	0,7			211		BR7HIX	7067
Ludix Tend	50	04 -	BR7HS	4122	0,7			211		BR7HIX	7067
Metal-X 50	50		BR7HS	4122	0,6			211		BR7HIX	7067
Rapido	50		BP6HS	4511	0,6	BP6HVX	4635			BPR6HIX	4085
Speedake	50		B7HS	5110	0,6	B7HVX	7836	204		BR7HIX	7067
Speedake 50	50		B7HS	5110	0,6	B7HVX	7836	204		BR7HIX	7067
Speedfight	50		BR8HS	4322	0,6	BR8HVX	6265	212		BR8HIX	7001
Speedfight AC Air	50	98 -	BR7HS	4122	0,7			211		BR7HIX	7067
Speedfight 2 50 AC / LC	50		BR7HS	4122	0,7			211		BR7HIX	7067







					Order No.		Platin 	Order No.	Quick-No.	Iridium 	Order No.
PEUGEOT											
Speedfight M	50	96 -	BR7HS	4122	0,6				211	BR7HIX	7067
Speedfight LC	50	96 -	BR7HS	4122	0,6				211	BR7HIX	7067
Speedfight LC "Prost X Team" Watercool	50	98 -	BR7HS	4122	0,7				211	BR7HIX	7067
Squab	50	96 -	BR8HS	4322	0,5	BR8HVX	6265	212	BR8HIX	7001	
Squab 50 (I)	50		BR8HS	4322	0,6	BR8HVX	6265	212	BR8HIX	7001	
ST 50 (I)	50		B7HS	5110	0,5	B7HVX	7836	204	BR7HIX	7067	
ST 50; Metropolis (I)	50		B7HS	5110	0,6	B7HVX	7836	204	BR7HIX	7067	
SV 50	50	- 95	B8HS	5510	0,6	B8HVX	2634	205	BR8HIX	7001	
SV 50	50	96 -	BR8HS	4322	0,6	BR8HVX	6265	212	BR8HIX	7001	
SV 50 Geo (I)	50		B8HS	5510	0,6	B8HVX	2634	205	BR8HIX	7001	
SV 50 Junior	50		B8HS	5510	0,6	B8HVX	2634	205	BR8HIX	7001	
TKR Streetboard 50 / WRC	50	00 -	BR7HS	4122	0,6				211	BR7HIX	7067
Trekker Road	50		BR7HS	4122	0,6				211	BR7HIX	7067
Trekker (I)	50		BR8HS	4322	0,6	BR8HVX	6265	212	BR8HIX	7001	
Trekker Off Road	50	98 -	BR7HS	4122	0,6				211	BR7HIX	7067
Vivacity 50	50	99 -	BR7HS	4122	0,7				211	BR7HIX	7067
Zenith 50 (I)	50		B7HS	5110	0,5	B7HVX	7836	204	BR7HIX	7067	
Zenith 50; F.D. (I)	50		B7HS	5110	0,6	B7HVX	7836	204	BR7HIX	7067	
Zenith F.D. 50 (I)	50		B7HS	5110	0,5	B7HVX	7836	204	BR7HIX	7067	
Zenith LM2	50	96 -	BR8HS	4322	0,5	BR8HVX	6265	212	BR8HIX	7001	
SV 80	80		B8HS	5510	0,6	B8HVX	2634	205	BR8HIX	7001	
Eliséo 100	100	98 -	BR8ES	5422	0,7	BR8EVX	1262	207	BR8EIX	5044	
Looxor 100	100	02.01 -	BR8ES	5422	0,6	BR8EVX	1262	207	BR8EIX	5044	
Speedfight 100	100	96 - 03	BR8ES	5422	0,6	BR8EVX	1262	207	BR8EIX	5044	
Speedfight 2 100	100	03 -	BR8ES	5422	0,6	BR8EVX	1262	207	BR8EIX	5044	
SV 100	100	96 -	BR8ES	5422	0,6	BR8EVX	1262	207	BR8EIX	5044	
TKR 100	100	00 -	BR8ES	5422	0,6	BR8EVX	1262	207	BR8EIX	5044	
Trekker 100	100	98 -	BR8ES	5422	0,6	BR8EVX	1262	207	BR8EIX	5044	
Vivacity 100	100	99 -	BR8ES	5422	0,7	BR8EVX	1262	207	BR8EIX	5044	
Eliséo 125	125	98 -	CR8E	1275	0,7	CR8EVX	6487	226	CR8EIX	4218	
Eliséo Advantage 125	125	04 -	CR8E	1275	0,7	CR8EVX	6487	226	CR8EIX	4218	
Elystar ABS/PBS 125	125		CR8E	1275	0,7	CR8EVX	6487	226	CR8EIX	4218	
Elystar 125	125		CR8E	1275	0,7	CR8EVX	6487	226	CR8EIX	4218	
Geopolis 125	125	06 -	CR7EB	4663	0,6						
Jet Force 125	125	03.03 -	CR7EB	4663	0,6						
Jet Force 125 Compressor	125	05 -	CR8EK	3478	0,7				CR8EIX	4218	
Looxor 125	125		CR7EB	4663	0,6						
Ludix 125	125	04 -	CR7EB	4663	0,6						
Satelis 125 Kompressor	125	06 -	CR7EB	4663	0,6						
Satelis 125	125	04 -	CR7EB	4663	0,6						
SV 125	125		BP6HS	4511	0,6	BP6HVX	4635		BPR6HIX	4085	
SV 125; Metropolis (I)	125		BP6HS	4511	0,6	BP6HVX	4635		BPR6HIX	4085	
Elyseo 150	150	00 -	CR8E	1275	0,7	CR8EVX	6487	226	CR8EIX	4218	
Elystar 150	150		CR7E	4578	0,7			225	CR7EIX	7385	
Looxor 150	150		CR7EB	4663	0,6						
Satelis 250	250	06 -	CR7EB	4663	0,6						
SV 250	250	01 -	DPR7EA-9	5129	0,9	DPR7EVX-9	7682	220	DPR7EIX-9	7803	
PGO											
Big Max 25/50	50		BPR7HS	6422	0,5	BPR7HVX	2938	215	BPR7HIX	5944	
Big Max 50	50		BPR7HS	6422	0,5	BPR7HVX	2938	215	BPR7HIX	5944	
Big Max Sport 50	50	96 -	BP7HS	5111	0,6	BP7HVX	7468		BPR7HIX	5944	







						Order No.		Platin 	Order No.	Quick-No.	Iridium 	Order No.
PGO												
Comet	50		BP7HS	5111	0,6	BP7HVX	7468				BPR7HIX	5944
Galaxy 25	50		BP7HS	5111	0,6	BP7HVX	7468				BPR7HIX	5944
Galaxy 50	50		BP7HS	5111	0,6	BP7HVX	7468				BPR7HIX	5944
G-Max	50	04 -	BPR7HS	6422	0,6	BPR7HVX	2938		215		BPR7HIX	5944
Mega 50	50	96 -	BPR7HS	6422	0,5	BPR7HVX	2938		215		BPR7HIX	5944
New Galaxy 50 (I)	50		BP6HS	4511	0,6	BP6HVX	4635				BPR6HIX	4085
PMS 50	50	99 -	BP7HS	5111	0,6	BP7HVX	7468				BPR7HIX	5944
PMX 50	50	99 -	BP7HS	5111	0,6	BP7HVX	7468				BPR7HIX	5944
Rodoshow	50	02.00 -	BP7HS	5111	0,6	BP7HVX	7468				BPR7HIX	5944
Star 2	50		BP7HS	5111	0,6	BP7HVX	7468				BPR7HIX	5944
Star 50	50		BP6HS	4511	0,6	BP6HVX	4635				BPR6HIX	4085
Super Comet 50 (I)	50		BP7HS	5111	0,6	BP7HVX	7468				BPR7HIX	5944
Tornado 50	50	97 -	BPR7HS	6422	0,5	BPR7HVX	2938		215		BPR7HIX	5944
T-REX 50	50	99 -	BP7HS	5111	0,6	BP7HVX	7468				BPR7HIX	5944
Star 80	80		BP6HS	4511	0,6	BP6HVX	4635				BPR6HIX	4085
Big Max 90	82	96 -	BPR7HS	6422	0,5	BPR7HVX	2938		215		BPR7HIX	5944
Galaxy 90	90		BPR7HS	6422	0,6	BPR7HVX	2938		215		BPR7HIX	5944
G-Max	125	05 -	C7HSA	4629	0,7	C7HVX	4533				CR7HIX	7544
Tornado 1.25	125	97 -	BPR7HS	6422	0,5	BPR7HVX	2938		215		BPR7HIX	5944
T-REX 125 2T	125	99 -	BP7HS	5111	0,6	BP7HVX	7468				BPR7HIX	5944
T-REX 125 4T	125	99 -	C7HSA	4629	0,6	C7HVX	4533				CR7HIX	7544
T-REX 150 4T	150	03 -	C7HSA	4629	0,6	C7HVX	4533				CR7HIX	7544
PIAGGIO												
Free 25 Mofa	25		BP8ES	2912	0,5	BP8EVX	2671					
Zip 25 Mofa	25		BPR8ES	3923	0,5	BPR8EVX	5573		213			
Zip Base 25 / Mofa	25		BPR8ES	3923	0,5	BPR8EVX	5573		213			
50 R, Special	50		B6HS	4510	0,5	B6HVX	7435	203			BR6HIX	3419
50 S	50		B6HS	4510	0,5	B6HVX	7435	203			BR6HIX	3419
Boss	50		B6HS	4510	0,5	B6HVX	7435	203			BR6HIX	3419
Boss	50		B6HS	4510	0,6	B6HVX	7435	203			BR6HIX	3419
Bravo - Si / Moped	50		B5HS	4210	0,5							
Bravo PV	50		BR6HS	3922	0,7				209		BR6HIX	3419
Bravo P	50		BR6HS	3922	0,7				209		BR6HIX	3419
Ciao M Kat	50		BR6HS	3922	0,7				209		BR6HIX	3419
Ciao Mix / Mix	50		B5HS	4210	0,5							
Ciao V Kat	50		BR6HS	3922	0,7				209		BR6HIX	3419
Ciao-Bravo SI / Mofa	50		B5HS	4210	0,5							
Diesis 50	50		BR9ES	5722	0,7	BR9EVX	1265	208			BR9EIX	3981
Eaglet	50		B9ES	2611	0,5	B9EVX	7254	202			BR9EIX	3981
ET2 (iniezione / Einspritzer)	50	98 -	---		0,6	DCPR9EVX	6436					
ET2 (carbureter/Vergaser)	50	98 -	BR9ES	5722	0,6	BR9EVX	1265	208			BR9EIX	3981
Free Kat	50		BR9ES	5722	0,7	BR9EVX	1265	208			BR9EIX	3981
Free 50	50	93 -	B9ES	2611	0,5	B9EVX	7254	202			BR9EIX	3981
Free Business 50	50	01.96 -	B9ES	2611	0,6	B9EVX	7254	202			BR9EIX	3981
Grillo / Mofa	50		B5HS	4210	0,5							
Liberty	50	01.97 -	B9ES	2611	0,6	B9EVX	7254	202			BR9EIX	3981
Liberty Kat	50		BR9ES	5722	0,7	BR9EVX	1265	208			BR9EIX	3981
Liberty 4T	50	02 -	CR9EB	6955	0,8						CR9EIX	3521
NRG 50	50	01.94 -	B9ES	2611	0,6	B9EVX	7254	202			BR9EIX	3981
NRG H ² O Kat	50		B9ES	2611	0,5	B9EVX	7254	202			BR9EIX	3981
NRG mc3 Pure Jet	50	02 -	CPR8E	7411	0,6							







					Order No.		Platin 	Order No.	Quick-No.	Iridium 	Order No.
PIAGGIO											
NRG Extreme			B9ES	2611	0,5	B9EVX	7254	202		BR9EIX	3981
NRG mc2 DT,DD			B9ES	2611	0,5	B9EVX	7254	202		BR9EIX	3981
NRG Extreme Kat			B9ES	2611	0,5	B9EVX	7254	202		BR9EIX	3981
NRG mc2 50		01.96 -	B9EG	3530	0,6	B9EGV	5827			BR9EIX	3981
NRG			B9ES	2611	0,5	B9EVX	7254	202		BR9EIX	3981
NRG Power DT Purejet		05 -	CPR8E	7411	0,6						
NSP 4T (Aria)		02 -	CR9EB	6955	0,8					CR9EIX	3521
NTT 50		01.95 -	B9ES	2611	0,6	B9EVX	7254	202		BR9EIX	3981
PK 50 XL 2			BR7HS	4122	0,6				211	BR7HIX	7067
PK 50 SS			B7HS	5110	0,5	B7HVX	7836	204		BR7HIX	7067
PK 50 XL2 Auto			B8ES	2411	0,5	B8EVX	7051	201		BR8EIX	5044
PK 50 S Auto			BR7ES	5122	0,5	BR7EVX	4556				
PK 50 S		09.82 -12.87	B6HS	4510	0,5	B6HVX	7435	203		BR6HIX	3419
PK 50		09.82 -12.87	B6HS	4510	0,5	B6HVX	7435	203		BR6HIX	3419
Plurimatic			B6HS	4510	0,5	B6HVX	7435	203		BR6HIX	3419
PX 50			B6HS	4510	0,5	B6HVX	7435	203		BR6HIX	3419
Quarz 50		01.92 -	B9ES	2611	0,6	B9EVX	7254	202		BR9EIX	3981
Quarz 50 Automatic		06.92 -	B9ES	2611	0,5	B9EVX	7254	202		BR9EIX	3981
Rush			BR7HS	4122	0,6				211	BR7HIX	7067
Sfera 50 , FL, RL, RST			B9ES	2611	0,5	B9EVX	7254	202		BR9EIX	3981
Sfera 50		01.90 -	B9ES	2611	0,6	B9EVX	7254	202		BR9EIX	3981
Sfera 50 Automatico		01.91 -	B9ES	2611	0,5	B9EVX	7254	202		BR9EIX	3981
Sfera RL 50			B9ES	2611	0,6	B9EVX	7254	202		BR9EIX	3981
Skipper			BR9ES	5722	0,6	BR9EVX	1265	208		BR9EIX	3981
Storm Automatic		94 -	B9ES	2611	0,5	B9EVX	7254	202		BR9EIX	3981
Super Bravo / Mofa			B5HS	4210	0,5						
Super Bravo 2 Gang / Mofa			B5HS	4210	0,5						
TPH		93 -	B9ES	2611	0,5	B9EVX	7254	202		BR9EIX	3981
Typhoon air / X 50		01.96 -	BR9ES	5722	0,7	BR9EVX	1265	208		BR9EIX	3981
Velofax 50		01.95 -	B8ES	2411	0,5	B8EVX	7051	201		BR8EIX	5044
Velofax / Mofa			BP8ES	2912	0,6	BP8EVX	2671				
Velofax 50 AE		01.95 -	B8ES	2411	0,5	B8EVX	7051	201		BR8EIX	5044
Vespa ET2 IE			---			DCPR9EVX	6436				
Vespa Vale Especial/Standard			B5HS	4210	0,5						
Vespa 50 HP 4M		01.93 -	B7HS	5110	0,5	B7HVX	7836	204		BR7HIX	7067
Vespa Delta,Puch Condor			B7HS	5110	0,5	B7HVX	7836	204		BR7HIX	7067
Vespa ET 4		02 -	CR9EB	6955	0,8					CR9EIX	3521
Vespa HP 4M			B6HS	4510	0,5	B6HVX	7435	203		BR6HIX	3419
Vespa PK 50 XL 2 ,Automatic			B8ES	2411	0,5	B8EVX	7051	201		BR8EIX	5044
Vespa Elestart			B6HS	4510	0,5	B6HVX	7435	203		BR6HIX	3419
Vespa ET3 Primavera			BR7HS	4122	0,6				211	BR7HIX	7067
Vespino TX/XE			BR7HS	4122	0,6				211	BR7HIX	7067
Vespino NX/SC/T/TL/TN/TS			BR7HS	4122	0,6				211	BR7HIX	7067
Vespino			BR7HS	4122	0,6				211	BR7HIX	7067
Zip 50 Fast Rider		01.93 -	B9ES	2611	0,6	B9EVX	7254	202		BR9EIX	3981
Zip 50 RST			B9ES	2611	0,6	B9EVX	7254	202		BR9EIX	3981
Zip Kat			BPR8ES	3923	0,5	BPR8EVX	5573	213			
Zip 50		01.92 -	B9ES	2611	0,6	B9EVX	7254	202		BR9EIX	3981
Zip 50 SP		01.96 -	B9ES	2611	0,6	B9EVX	7254	202		BR9EIX	3981
Zip air		01.96 -	BR9ES	5722	0,7	BR9EVX	1265	208		BR9EIX	3981
Zip 4 4T			CR7E	4578	0,6				225	CR7EIX	7385
Zip water		01.96 -	B10ES	7928	0,7	B10EVX	7335			BR10EIX	6801







				Order No.		Platin 	Order No.	Quick-No.	Iridium 	Order No.
PIAGGIO										
Zip 50 SP	50		---		0,5	B9EG	3530			
Zip Base 50	50		B9ES	2611	0,5	B9EVX	7254	202	BR9EIX	3981
Zip & Zip 50	50	01.94 -	B9ES	2611	0,6	B9EVX	7254	202	BR9EIX	3981
Zip & Zip 50 4 T Aria	50	02 -	CR9EB	6955	0,8				CR9EIX	3521
Zip & Zip (Hybrid)	50	94 -	B9ES	2611	0,5	B9EVX	7254	202	BR9EIX	3981
SKR City	75		BR9ES	5722	0,6	BR9EVX	1265	208	BR9EIX	3981
Vespa PK 75S/ Elestart/ Junior	75		B7HS	5110	0,5	B7HVX	7836	204	BR7HIX	7067
Vespa PK 75XL/ Elestart	75		B9ES	2611	0,6	B9EVX	7254	202	BR9EIX	3981
Vespa PK 75S Primavera / T3 Prima.	75		B7HS	5110	0,5	B7HVX	7836	204	BR7HIX	7067
PK 80 S	80	09.82 -12.85	BR7HS	4122	0,6			211	BR7HIX	7067
PX 80 E Lusso	80		B6ES	7310	0,5	B6EVX	5136			
PX 80 E, P 80 X	80		B6ES	7310	0,5	B6EVX	5136			
Sfera 80 Automatic	80		B9ES	2611	0,5	B9EVX	7254	202	BR9EIX	3981
Skipper	80		B9ES	2611	0,6	B9EVX	7254	202	BR9EIX	3981
TPH Automatic	80	94 -	B9ES	2611	0,5	B9EVX	7254	202	BR9EIX	3981
Typhoon	80		BR9ES	5722	0,6	BR9EVX	1265	208	BR9EIX	3981
Diesis 100	100	01 -	CR8EB	7784	0,6	CR8EVX	6487		CR8EIX	4218
Free 100	100	02 -	CR8EB	7784	0,6	CR8EVX	6487		CR8EIX	4218
PK 100 S	100	06.82 -	BR7HS	4122	0,6			211	BR7HIX	7067
125 T5	125	03.85 -	B8ES	2411	0,6	B8EVX	7051	201	BR8EIX	5044
Ape	125		B7HS	5110	0,5	B7HVX	7836	204	BR7HIX	7067
Beverly 125	125	02 -	CR8EB	7784	0,6	CR8EVX	6487		CR8EIX	4218
Cosa 125 MA AE	125	01.88 -	B9ES	2611	0,6	B9EVX	7254	202	BR9EIX	3981
Cosa 200 FL EBC 12PS	125		B8ES	2411	0,5	B8EVX	7051	201	BR8EIX	5044
Cosa FL 125	125	91 -	B9ES	2611	0,5	B9EVX	7254	202	BR9EIX	3981
Cosa 125	125	- 91	B8ES	2411	0,5	B8EVX	7051	201	BR8EIX	5044
ET 3	125		BR7HS	4122	0,6			211	BR7HIX	7067
ET 4 Automatic	125		CR7EB	4663	0,6					
Fly 125	125	05 -	CR7EB	4663	0,6					
Hexagon LX 4Takt 2V Air	125		CR7EB	4663	0,6					
Hexagon LX 4T / 4V H2O watercoler	125		CR8EB	7784	0,6	CR8EVX	6487		CR8EIX	4218
Hexagon LX 125	125	94 -	B9ES	2611	0,5	B9EVX	7254	202	BR9EIX	3981
Liberty 125	125		CR7E	4578	0,6			225	CR7EIX	7385
Liberty 4Takt	125		CR7EB	4663	0,6					
P 125 ETS	125	01.83 -12.85	BR7HS	4122	0,6			211	BR7HIX	7067
PK 125 XL 2	125		B8ES	2411	0,5	B8EVX	7051	201	BR8EIX	5044
PK 125 XL Automatic	125		BR7HS	4122	0,6			211	BR7HIX	7067
PK Automatic	125		B7HS	5110	0,5	B7HVX	7836	204	BR7HIX	7067
PK 125, E, S	125		BR6HS	3922	0,5			209	BR6HIX	3419
Primavera	125	01.76 -12.83	BR7HS	4122	0,6			211	BR7HIX	7067
PX 125 E Lusso	125	01.82 -	B6HS	4510	0,5	B6HVX	7435	203	BR6HIX	3419
Sfera 125	125	01.95 -	CR9E	6263	0,6	CR9EVX	5943	227	CR9EIX	3521
Sfera RL 125 - 4Takt	125		CR9E	6263	0,6	CR9EVX	5943	227	CR9EIX	3521
Sfera RST 4 Takt	125	95 -	CR7E	4578	0,6			225	CR7EIX	7385
Skipper 125 LX	125	01.93 -	B9ES	2611	0,6	B9EVX	7254	202	BR9EIX	3981
Skipper 125 4 Takt	125	00 -	CR7EB	4663	0,6					
SKR 125	125	08.93 -	B9ES	2611	0,5	B9EVX	7254	202	BR9EIX	3981
Super Hexagon GTX 125 4Takt	125	01 -	CR8EB	7784	0,6	CR8EVX	6487		CR8EIX	4218
TPH	125	95 -	B9ES	2611	0,5	B9EVX	7254	202	BR9EIX	3981
Vespa T3Li/T3	125		B6HS	4510	0,5	B6HVX	7435	203	BR6HIX	3419
Vespa 125 T5 Sport/ Elestart	125		B9ES	2611	0,6	B9EVX	7254	202	BR9EIX	3981
Vespa 125 CL/LN/ NK Primavera	125		B6HS	4510	0,5	B6HVX	7435	203	BR6HIX	3419







					Order No.		Platin 	Order No.	Quick-No.	Iridium 	Order No.
PIAGGIO											
Vespa XL 125 Plurimat/Elestart	125		B7HS	5110	0,6	B7HVX	7836	204	BR7HIX	7067	
Vespa Special ET3 Primavera	125		B7HS	5110	0,6	B7HVX	7836	204	BR7HIX	7067	
Vespa GT	125	03 -	CR8EB	7784	0,6	CR8EVX	6487		CR8EIX	4218	
Vespa PK 125	125	85 -	BR7HS	4122	0,6			211	BR7HIX	7067	
Vespa PX 125 MA AE	125	86 -	B6HS	4510	0,5	B6HVX	7435	203	BR6HIX	3419	
Vespa T5	125		B9ES	2611	0,5	B9EVX	7254	202	BR9EIX	3981	
Vespa Gandturisticmo	125	-04.04	CR9EB	6955	0,6				CR9EIX	3521	
Vespa LX 125	125	05 -	CR7EB	4663	0,6						
Vespa PX 125 Kat	125		B9ES	2611	0,5	B9EVX	7254	202	BR9EIX	3981	
Vespa ET4	125	99 -	CR7EB	4663	0,6						
Vespa ET4 125	125	01.96 -	CR8EB	7784	0,7	CR8EVX	6487		CR8EIX	4218	
Vespa 125 FL2	125	01.90 -	B7HS	5110	0,6	B7HVX	7836	204	BR7HIX	7067	
Vespa PX 125 MA AE	125	01.96 -	B6HS	4510	0,6	B6HVX	7435	203	BR6HIX	3419	
Vespa Special ET4 Carburatore	125		CR8EB	7784	0,6	CR8EVX	6487		CR8EIX	4218	
X 8	125	04 -	CR8EB	7784	0,6	CR8EVX	6487		CR8EIX	4218	
X 9 11kW	125	-04.02	CR9EB	6955	0,6				CR9EIX	3521	
X 9 11kW	125	05.02 -	CR8EB	7784	0,6	CR8EVX	6487		CR8EIX	4218	
Zip 125	125		CR9EB	6955	0,6				CR9EIX	3521	
Cosa	150		BR9ES	5722	0,6	BR9EVX	1265	208	BR9EIX	3981	
EX 150 (Hexagon)	150	94 -	B9ES	2611	0,5	B9EVX	7254	202	BR9EIX	3981	
Hexagon 150	150	01.94 -	B9ES	2611	0,6	B9EVX	7254	202	BR9EIX	3981	
Liberty	150		CR7EB	4663	0,6						
PX 150 E Lusso	150	01.82 -	B6HS	4510	0,5	B6HVX	7435	203	BR6HIX	3419	
Skipper 150	150	01.93 -	B9ES	2611	0,6	B9EVX	7254	202	BR9EIX	3981	
Skipper ST 150 4Takt	150	- 00	BR9ES	5722	0,7	BR9EVX	1265	208	BR9EIX	3981	
Skipper ST 4T	150	01 -	CR7EB	4663	0,6						
SKR 150	150	98 -	B9ES	2611	0,5	B9EVX	7254	202	BR9EIX	3981	
Vespa 150 long 19,0 mm	150		B6ES	6955	0,5	B6EVX	5136				
Vespa 150 ET 4	150	02 -	CR7EB	4663	0,8						
Vespa 150 ET4	150	01 - 02	CR8EB	7784	0,6	CR8EVX	6487		CR8EIX	4218	
Vespa PX 150 Kat	150		BR6HS	3922	0,7			209	BR6HIX	3419	
Vespa 150 ET4	150	- 01	CR7E	4578	0,6			225	CR7EIX	7385	
Vespa PX 150 MA AE	150	01.96 -	B6HS	4510	0,6	B6HVX	7435	203	BR6HIX	3419	
Vespa PX 150 MA AE	150	86 -	B6HS	4510	0,5	B6HVX	7435	203	BR6HIX	3419	
Vespa 150 long 12,7 mm	150		B6HS	4510	0,5	B6HVX	7435	203	BR6HIX	3419	
Vespa 160/ GT	160		B6HS	4510	0,5	B6HVX	7435	203	BR6HIX	3419	
Vespa 175	175		B6HS	4510	0,5	B6HVX	7435	203	BR6HIX	3419	
Hexagon LXT 180	180	01.98 -	B9ES	2611	0,6	B9EVX	7254	202	BR9EIX	3981	
Super Hexagon LXT 180	180	01 -	CR8EB	7784	0,6	CR8EVX	6487		CR8EIX	4218	
Vespa SS	180		B6HS	4510	0,5	B6HVX	7435	203	BR6HIX	3419	
X 9 4T Amalfi	180	01 -	CR8EB	7784	0,6	CR8EVX	6487		CR8EIX	4218	
Ape	190		B7HS	5110	0,5	B7HVX	7836	204	BR7HIX	7067	
Cosa 2 200	200	01.88 - 91	BR8ES	5422	0,6	BR8EVX	1262	207	BR8EIX	5044	
Cosa 200 Aluzyl.12PS	200	93 - 97	BR8ES	5422	0,6	BR8EVX	1262	207	BR8EIX	5044	
Beverly 200	200	01 -	CR8EB	7784	0,6	CR8EVX	6487		CR8EIX	4218	
Cosa MA AE	200		BR8ES	5422	0,6	BR8EVX	1262	207	BR8EIX	5044	
Cosa 2 200 MA AE	200	01.88 -	BR8ES	5422	0,6	BR8EVX	1262	207	BR8EIX	5044	
Cosa 200 MA AE	200	01.88 -	BR8ES	5422	0,6	BR8EVX	1262	207	BR8EIX	5044	
Cosa FL 200	200	91 -	BR8ES	5422	0,6	BR8EVX	1262	207	BR8EIX	5044	
DN	200		BR7ES	5122	0,5	BR7EVX	4556				
DS	200		BR7ES	5122	0,5	BR7EVX	4556				
PE	200		BR7ES	5122	0,5	BR7EVX	4556				







						Order No.		Platin 	Order No.	Quick-No.	Iridium 	Order No.
PIAGGIO												
PX 200 E Grand-Sport	200	01.84 -	BR7ES	5122	0,5	BR7EVX	4556					
PX 200 E Lusso	200	01.84 -	BR7ES	5122	0,5	BR7EVX	4556					
Vespa PX 200E/Iris/Iris Elestart	200		B7ES	1111	0,6	B7EVX	6934					
Vespa 200 TX/Elestart	200		B7ES	1111	0,6	B7EVX	6934					
Vespa 200 DN/ DS/ E	200		B5ES	6410	0,5							
Vespa PX 200 MA AE	200	86 -	B6ES	7310	0,5	B6EVX	5136					
Vespa PX 200 MA AE	200	01.96 -	B6ES	7310	0,6	B6EVX	5136					
Vespa Granturimo 200 L	200		CR7EKB	4455	0,6							
Vespa Rally	200		BR7ES	5122	0,5	BR7EVX	4556					
X 8 200	200	05 -	CR7EKB	4455	0,6							
Ape	220		B7HS	5110	0,5	B7HVX	7836	204		BR7HIX	7067	
Beverly 250	250	03 -	CR7EKB	4455	0,6							
Hexagon GT 250 4Takt	250	98 -	DPR6EA-9	5531	0,9							
Super Hexagon GTX 250	250		CR9E	6263	0,7	CR9EVX	5943	227		CR9EIX	3521	
X 9 (4T)	250	00 - 03	DPR7EA-9	5129	0,9	DPR7EVX-9	7682	220		DPR7EIX-9	7803	
Beverly 500	500	03 -	CR7EKB	4455	0,6							
X 9 EVO (4T)	500	04 -	CR7EKB	4455	0,6							
X 9 (4T)	500	11.03 -	CR7EKB	4455	0,6							
PUCH												
Lido	50		BPR6HS	7022	0,7	BPR6HVX	2740	214		BPR6HIX	4085	
Lido 125	125		DR8ES	5423	0,7	DR8EVX	6354	217		DR8EIX	6681	
RENAULT SPORT												
Campus	50	01 -	BR8ES	5422	0,6	BR8EVX	1262	207		BR8EIX	5044	
Spécimen	50	01 -	BR8HS	4322	0,6	BR8HVX	6265	212		BR8HIX	7001	
Spécimen	100	01 -	BR8HS	4322	0,6	BR8HVX	6265	212		BR8HIX	7001	
Fulltime	125	01 -	CR9EB	6955	0,6					CR9EIX	3521	
Groomy	125	01 -	CR9EB	6955	0,6					CR9EIX	3521	
Kouranos	125	01 -	CR9EB	6955	0,6					CR9EIX	3521	
REX												
Rex 25	25		BPR7HS	6422	0,6	BPR7HVX	2938	215		BPR7HIX	5944	
Rexy 50	25	96 -	BPR7HS	6422	0,6	BPR7HVX	2938	215		BPR7HIX	5944	
Rexy 25	25	96 -	BPR7HS	6422	0,6	BPR7HVX	2938	215		BPR7HIX	5944	
Rex 50	50	96 -	BPR7HS	6422	0,6	BPR7HVX	2938	215		BPR7HIX	5944	
Scooter	50	96 -	BPR7HS	6422	0,6	BPR7HVX	2938	215		BPR7HIX	5944	
Silver Star	50		BPR7HS	6422	0,6	BPR7HVX	2938	215		BPR7HIX	5944	
Silver Street	50		BPR7HS	6422	0,6	BPR7HVX	2938	215		BPR7HIX	5944	
Rex 125	125	97 -	CR7HSA	4549	0,5					CR7HIX	7544	
Rexy 125	125		CR7HSA	4549	0,5					CR7HIX	7544	
RIEJU												
Drac 50 (AM5)	50	96 -	BR8ES	5422	0,6	BR8EVX	1262	207		BR8EIX	5044	
MRX 50 EURO (AM6)	50	02 -	BR9ES	5722	0,6	BR9EVX	1265	208		BR9EIX	3981	
MRX 50 Top (AM6)	50	03 -	BR9ES	5722	0,6	BR9EVX	1265	208		BR9EIX	3981	
MX 50 Infantil (Morini S5)	50	01 - 01	B6HS	4510	0,5	B6HVX	7435	203		BR6HIX	3419	
MX 50 Infantil (Morini S6)	50	02 -	B9ES	2611	0,6	B9EVX	7254	202		BR9EIX	3981	
NKD 50 (AM6)	50	03 -	BR9ES	5722	0,6	BR9EVX	1265	208		BR9EIX	3981	
RR 50 (AM5)	50	97 -	BR8ES	5422	0,6	BR8EVX	1262	207		BR8EIX	5044	
RR 50 (AM6)	50	01 -	BR8ES	5422	0,6	BR8EVX	1262	207		BR8EIX	5044	
RR 50 Castrol (AM6)	50	02 -	BR9ES	5722	0,6	BR9EVX	1265	208		BR9EIX	3981	

				Order No.		Platin 	Order No.	Quick-No.	Iridium 	Order No.	
RIEJU											
RR 50 EURO (AM6)	50	02 -	BR9ES	5722	0,6	BR9EVX	1265	208	BR9EIX	3981	
RS1 (AM5)	50	97 -	BR8ES	5422	0,6	BR8EVX	1262	207	BR8EIX	5044	
RS1 EVO (AM6)	50	98 -	BR8ES	5422	0,6	BR8EVX	1262	207	BR8EIX	5044	
RS1 EVO EURO (AM6)	50	02 -	BR9ES	5722	0,6	BR9EVX	1265	208	BR9EIX	3981	
RS2 Matrix (AM6)	50	03 -	BR9ES	5722	0,6	BR9EVX	1265	208	BR9EIX	3981	
SMX 50 EURO (AM6)	50	02 -	BR9ES	5722	0,6	BR9EVX	1265	208	BR9EIX	3981	
Windy (MY50)	50		BR7HS	4122	0,5			211	BR7HIX	7067	
MRX 125 (Yamaha)	125	02 -	CR7HSA	4549	0,6				CR7HIX	7544	
SMX 125 (Yamaha)	125	02 -	CR7HSA	4549	0,6				CR7HIX	7544	
RIVERO											
Linos 50	50		BPR7HS	6422	0,5	BPR7HVX	2938	215	BPR7HIX	5944	
ROYAL											
Royal 125	125	96 -	C7HSA	4629	0,6	C7HVX	4533		CR7HIX	7544	
SACHS											
49er	50	05 -	CR7HSA	4549	0,5				CR7HIX	7544	
Buxy (RS)	50		B7HS	5110	0,6	B7HVX	7836	204	BR7HIX	7067	
City Roller CV 50	50		BPR6HS	7022	0,7	BPR6HVX	2740	214	BPR6HIX	4085	
Limbo	50		BP6HS	4511	0,6	BP6HVX	4635		BPR6HIX	4085	
MadAss 50	50	04 -	CR7HSA	4549	0,6				CR7HIX	7544	
Reggae (RS)	50		B7HS	5110	0,6	B7HVX	7836	204	BR7HIX	7067	
Samba SR	50		B8HS	5510	0,5	B8HVX	2634	205	BR8HIX	7001	
Speedake	50		B7HS	5110	0,6	B7HVX	7836	204	BR7HIX	7067	
Speedfight 50 AC	50	97 -	BR7HS	4122	0,6				211	BR7HIX	7067
Speedfight 50 LC	50	97 -	BR7HS	4122	0,6				211	BR7HIX	7067
Speedfight 50 LC ADT	50	97 -	BR7HS	4122	0,6				211	BR7HIX	7067
Splinter	50		B7HS	5110	0,6	B7HVX	7836	204	BR7HIX	7067	
Squab	50		BR8HS	4322	0,6	BR8HVX	6265	212	BR8HIX	7001	
SR 50	50		B8HS	5510	0,6	B8HVX	2634	205	BR8HIX	7001	
SV 50	50		B8HS	5510	0,6	B8HVX	2634	205	BR8HIX	7001	
SV 50 Junior	50		B8HS	5510	0,6	B8HVX	2634	205	BR8HIX	7001	
Zenith	50		BP6HS	4511	0,6	BP6HVX	4635		BPR6HIX	4085	
City Roller CV 80	80		BPR6HS	7022	0,7	BPR6HVX	2740	214	BPR6HIX	4085	
City Roller CV 80 E	80		BR8HS	4322	0,7	BR8HVX	6265	212	BR8HIX	7001	
SR 80	80		B8HS	5510	0,6	B8HVX	2634	205	BR8HIX	7001	
SV 80	80		B8HS	5510	0,6	B8HVX	2634	205	BR8HIX	7001	
SR 125	125		BP6HS	4511	0,6	BP6HVX	4635		BPR6HIX	4085	
SR 125 C	125		BP6HS	4511	0,6	BP6HVX	4635		BPR6HIX	4085	
Superduke	125	97 -	C7HSA	4629	0,6	C7HVX	4533		CR7HIX	7544	
SV 125	125		BP6HS	4511	0,6	BP6HVX	4635		BPR6HIX	4085	
SV 125 C	125		BP6HS	4511	0,6	BP6HVX	4635		BPR6HIX	4085	
SAN YANG											
Fancy 50	50	10.95 -	BR8HSA	5539	0,6	BR8HVX	6265		BR8HIX	7001	
Flash 50	50		BR8HSA	5539	0,6	BR8HVX	6265		BR8HIX	7001	
Free 50	50		BR8HSA	5539	0,6	BR8HVX	6265		BR8HIX	7001	
Jet 50	50		BR8HSA	5539	0,6	BR8HVX	6265		BR8HIX	7001	
Mike 50	50		BR8HSA	5539	0,6	BR8HVX	6265		BR8HIX	7001	
Pure 50	50		BR8HSA	5539	0,6	BR8HVX	6265		BR8HIX	7001	
Red Devil 50	50		BR8HSA	5539	0,6	BR8HVX	6265		BR8HIX	7001	

				Order No.		Gold-Palladium	Platin 	Order No.	Quick-No.	Iridium 	Order No.
SAN YANG											
Super Fancy 50	50		BR8HSA	5539	0,6	BR8HVX	6265			BR8HIX	7001
Duke 125	125		C7HSA	4629	0,6	C7HVX	4533			CR7HIX	7544
Super Duke 125	125		C7HSA	4629	0,6	C7HVX	4533			CR7HIX	7544
SASY											
Classic 200 E	50	96 -	BPR6HS	7022	0,5	BPR6HVX	2740	214		BPR6HIX	4085
JC 50	50	96 -	C7HSA	4629	0,6	C7HVX	4533			CR7HIX	7544
Jet 50	50	96 -	BPR6HS	7022	0,5	BPR6HVX	2740	214		BPR6HIX	4085
Mulan B	50	96 -	BPR6HS	7022	0,5	BPR6HVX	2740	214		BPR6HIX	4085
Mulan Super AG	50	96 -	BPR6HS	7022	0,5	BPR6HVX	2740	214		BPR6HIX	4085
Standard 50	50	96 -	BPR6HS	7022	0,5	BPR6HVX	2740	214		BPR6HIX	4085
SHE LUNG											
Club (I)	50		BP7HS	5111	0,6	BP7HVX	7468			BPR7HIX	5944
Racer (I)	50		BP7HS	5111	0,6	BP7HVX	7468			BPR7HIX	5944
SIAM											
Falkon 50	50	97 -	BR7HS	4122	0,6			211		BR7HIX	7067
Scros (I)	50		BPR6HS	7022	0,6	BPR6HVX	2740	214		BPR6HIX	4085
Scross	50		BPR6HS	7022	0,7	BPR6HVX	2740	214		BPR6HIX	4085
SIAMOTO											
Birdie 25 Mofa	25	99 -	BPR6HS	7022	0,7	BPR6HVX	2740	214		BPR6HIX	4085
Sross 50	50	99 -	BR7HS	4122	0,5			211		BR7HIX	7067
Capri 125 4-Takt	125	99 -	C7HSA	4629	0,7	C7HVX	4533			CR7HIX	7544
Favourite 125 4-Takt	125	99 -	C7HSA	4629	0,7	C7HVX	4533			CR7HIX	7544
KD 125 4-Takt	125	99 -	C7HSA	4629	0,7	C7HVX	4533			CR7HIX	7544
SIMSON											
City 2000	50	95 -	B8HS	5510	0,6	B8HVX	2634	205		BR8HIX	7001
SR 50 (1B)	50		B8HS	5510	0,6	B8HVX	2634	205		BR8HIX	7001
SR 50 (1XCE) Gamma	50		B8HS	5510	0,6	B8HVX	2634	205		BR8HIX	7001
SR 50 (1XG) Gamma	50		B8HS	5510	0,6	B8HVX	2634	205		BR8HIX	7001
Star 50	50	96 -	BPR6HS	7022	0,7	BPR6HVX	2740	214		BPR6HIX	4085
Hot Summer 80	70	97 -	B9HS	5810	0,4	B9HVX	2254				
Star Classic 80	70	97 -	B9HS	5810	0,4	B9HVX	2254				
SR 80 /1B	80		B8HS	5510	0,6	B8HVX	2634	205		BR8HIX	7001
SR 80 /1XCE	80		B8HS	5510	0,6	B8HVX	2634	205		BR8HIX	7001
STAR QUAD											
Jinlun JL50QT-5 Roller 50	50		C7HSA	4629	0,7	C7HVX	4533			CR7HIX	7544
STEFFEN											
Steffi	50	98 -	BP6HS	4511	0,6	BP6HVX	4635			BPR6HIX	4085
Steffi S	50	98 -	BP6HS	4511	0,6	BP6HVX	4635			BPR6HIX	4085
SUNDIRO											
Speedy 50	50	96 -	---		0,6	B9EVX	7254				
Speedy 80	80		---		0,6	B9EVX	7254				
Phönix XDZ 125 T	125	96 -	CR7HSA	4549	0,6					CR7HIX	7544
Phönix XDZ 125 TA	125	96 -	CR7HSA	4549	0,6					CR7HIX	7544

					Order No.		Platin 	Order No.	Quick-No. 	Iridium	Order No.
SUZUKI											
Address (I)	50		BPR6HS	7022	0,6	BPR6HVX	2740	214	BPR6HIX		4085
AH 50 (I)	50	01.92 -	BPR6HS	7022	0,6	BPR6HVX	2740	214	BPR6HIX		4085
AH 50 Address (CA1GA)	50	92 -	BPR6HS	7022	0,7	BPR6HVX	2740	214	BPR6HIX		4085
AH 50 GP	50	95 -	BPR6HS	7022	0,6	BPR6HVX	2740	214	BPR6HIX		4085
AJ 50 ZZ (I)	50	95 -	BPR7HS	6422	0,5	BPR7HVX	2938	215	BPR7HIX		5944
AP 50 S CA1JA)	50	95 -	BPR6HS	7022	0,6	BPR6HVX	2740	214	BPR6HIX		4085
AP 50 T (I)	50	96 -	BPR6HS	7022	0,7	BPR6HVX	2740	214	BPR6HIX		4085
AY Katana WRX/WR/W (AA)	50	97 -	BPR6HS	7022	0,6	BPR6HVX	2740	214	BPR6HIX		4085
AY 50 Katana (Di-Tech)	50	05 -	CPR8E	7411	0,6						
CP 50 (I)	50	89 - 92	BPR6HS	7022	0,7	BPR6HVX	2740	214	BPR6HIX		4085
UF50 Estilete (WVBA)	50	00 -	BPR7HS	6422	0,6	BPR7HVX	2938	215	BPR7HIX		5944
UX 50 W Zillion (AT)	50	99 -	BPR6HS	7022	0,7	BPR6HVX	2740	214	BPR6HIX		4085
AH 100 (I)	100	- 93	BPR7HS	6422	0,5	BPR7HVX	2938	215	BPR7HIX		5944
AH 100 (I)	100	- 93	BPR7HS	6422	0,6	BPR7HVX	2938	215	BPR7HIX		5944
AH 100 (CE12A)	100	95 -	BPR7HS	6422	0,7	BPR7HVX	2938	215	BPR7HIX		5944
AN 125 (CF42A)	125	95 - 95	CR8E	1275	0,7	CR8EVX	6487	226	CR8EIX		4218
AN 125 (CF42A)	125	96 -	CR7E	4578	0,7				225	CR7EIX	7385
AN 125 S (I)	125	95 -	CR8E	1275	0,7	CR8EVX	6487	226	CR8EIX		4218
AN 125 T (I)	125	01.96 -	CR7E	4578	0,7				225	CR7EIX	7385
UC 125 / U Epicuro (AX)	125	99 -	CR8E	1275	0,7	CR8EVX	6487	226	CR8EIX		4218
UE 125 (WVBH)	125	01 -	CR7E	4578	0,7				225	CR7EIX	7385
UH 125 (WVBP)	125	02 -	CR8E	1275	0,7	CR8EVX	6487	226	CR8EIX		4218
AN 150 T (I)	150	01.96 -	CR7E	4578	0,7				225	CR7EIX	7385
AN 250 Burgman (AN/WVAN)	250	05.98 -	CR8EK	3478	0,7					CR8EIX	4218
AN 400 Burgman (AU/WVAU)/(WVBW)	400	99 -	CR7E	4578	0,7				225	CR7EIX	7385
AN 650 Burgmann 650 (K3)/(K4)	650	03 -	CR8E	1275	0,7	CR8EVX	6487	226	CR8EIX		4218
SYM											
DD 50	50		BR8HSA	5539	0,6	BR8HVX	6265		BR8HIX		7001
Fancy	50	96 -	BR8HSA	5539	0,6	BR8HVX	6265		BR8HIX		7001
Fiddle 50	50		BR8HSA	5539	0,6	BR8HVX	6265		BR8HIX		7001
Flash	50	96 -	BR8HSA	5539	0,6	BR8HVX	6265		BR8HIX		7001
Free	50	96 -	BR8HSA	5539	0,6	BR8HVX	6265		BR8HIX		7001
Jet	50	96 -	BR8HSA	5539	0,6	BR8HVX	6265		BR8HIX		7001
Mask 50	50		BR8HSA	5539	0,6	BR8HVX	6265		BR8HIX		7001
Pure 50	50	96 -	BR8HSA	5539	0,6	BR8HVX	6265		BR8HIX		7001
Red Devil	50		BR8HSA	5539	0,6	BR8HVX	6265		BR8HIX		7001
Shark 50	50		BR8HSA	5539	0,6	BR8HVX	6265		BR8HIX		7001
Super Fancy	50	96 -	BR8HSA	5539	0,6	BR8HVX	6265		BR8HIX		7001
GTS 125	125	06 -	CR8E	1275	0,7	CR8EVX	6487	226	CR8EIX		4218
HD 125	125		CR8E	1275	0,7	CR8EVX	6487	226	CR8EIX		4218
Joyride 125	125	03 -	CR7HSA	4549	0,6					CR7HIX	7544
Megalo 125	125		C7HSA	4629	0,7	C7HVX	4533			CR7HIX	7544
Shark 125	125	99 -	C7HSA	4629	0,7	C7HVX	4533			CR7HIX	7544
Super Duke 125	125	96 -	C7HSA	4629	0,7	C7HVX	4533			CR7HIX	7544
HD 200	200	05 -	CR8E	1275	0,7	CR8EVX	6487	226	CR8EIX		4218
GTS 250	250	06 -	CR8E	1275	0,7	CR8EVX	6487	226	CR8EIX		4218
500 GT	500	04 -	CR7EKB	4455	0,6						
500 XP	500	04 -	CR7EKB	4455	0,6						
T.G.M. BIMOTA											
Akros 50	50		BP6HS	4511	0,7	BP6HVX	4635		BPR6HIX		4085

				Order No.		Gold-Palladium	Platin 	Order No.	Quick-No.	Iridium 	Order No.
T.G.M. BIMOTA											
Ergon 50	50		BP6HS	4511	0,7	BP6HVX	4635			BPR6HIX	4085
TGB											
Bunny AS 50 X	50		BP6HS	4511	0,6	BP6HVX	4635			BPR6HIX	4085
KBX 50	50		BP6HS	4511	0,6	BP6HVX	4635			BPR6HIX	4085
TOKAIDO											
2000 K50	50	96 -	BR7HS	4122	0,6				211	BR7HIX	7067
50 V	50		BP7HS	5111	0,6	BP7HVX	7468			BPR7HIX	5944
SM 50	50		BP7HS	5111	0,6	BP7HVX	7468			BPR7HIX	5944
SM 50/1	50		BP7HS	5111	0,6	BP7HVX	7468			BPR7HIX	5944
VELOCIFERO											
Velocifero 50 (I)	50		B8HS	5510	0,6	B8HVX	2634	205		BR8HIX	7001
VESPA											
-> PIAGGIO											
VILLA BS											
Giorno 50 (I)	50		BR8HSA	5539	0,6	BR8HVX	6265			BR8HIX	7001
GP 50 Dio (I)	50		BPR8HS	3725	0,6					BPR8HIX	6742
SP 50 Dio (I)	50		BPR7HS	6422	0,6	BPR7HVX	2938	215		BPR7HIX	5944
Z5 50 (I)	50		BR8HSA	5539	0,6	BR8HVX	6265			BR8HIX	7001
ZX 50 (I)	50		BR8HSA	5539	0,6	BR8HVX	6265			BR8HIX	7001
VIVA											
Viva 50	50	96 -	BP7HS	5111	0,5	BP7HVX	7468			BPR7HIX	5944
WINKING											
Bunny AS / AT / AX	50		BP7HS	5111	0,7	BP7HVX	7468			BPR7HIX	5944
Bunny AS 50 X	50		BP6HS	4511	0,7	BP6HVX	4635			BPR6HIX	4085
Koala 2	50		B5HS	4210	0,6						
Koala LM	50		B6HS	4510	0,6	B6HVX	7435	203		BR6HIX	3419
Scooty Roller	50		B6HS	4510	0,6	B6HVX	7435	203		BR6HIX	3419
WP											
Wave 50	50	96 -	BPR7HS	6422	0,5	BPR7HVX	2938	215		BPR7HIX	5944
YAMAHA											
Aerox	50	97 -	BR8HS	4322	0,6	BR8HVX	6265	212		BR8HIX	7001
Aerox Racing	50	04 -	BR8HS	4322	0,6	BR8HVX	6265	212		BR8HIX	7001
Aerox R Toyota Racing	50	03 -	BR8HS	4322	0,6	BR8HVX	6265	212		BR8HIX	7001
Axis (YA50R) (3UG)	50	97 -	BR8HS	4322	0,7	BR8HVX	6265	212		BR8HIX	7001
Axis 50 (I)	50	01.95 -	BR7HS	4122	0,6					BR7HIX	7067
Axis Mofa (5AK)(YA50R)	50	97 -	BR7HS	4122	0,7				211	BR7HIX	7067
Beluga (I)	50		BP7HS-10	7829	1,0						
Breeze (4RC)(YM50)	50	95 -	BR8HS	4322	0,7	BR8HVX	6265	212		BR8HIX	7001
Breeze 50 (I)	50	01.94 -	BR7HS	4122	0,6				211	BR7HIX	7067
BW'S NG 99 (SA056)	50	99 -	BR8HS	4322	0,6	BR8HVX	6265	212		BR8HIX	7001
BW 50 Spy (CW50RSP;4VA)	50	96 -	BR8HS	4322	0,7	BR8HVX	6265	212		BR8HIX	7001
BW 50 (4BX)	50	91 - 95	BR7HS	4122	0,7					BR7HIX	7067
BW 50 (CW50)	50	96 -	BR8HS	4322	0,7	BR8HVX	6265	212		BR8HIX	7001

					Order No.		Platin 	Order No.	Quick-No.	Iridium 	Order No.
YAMAHA											
BW 50 Bump (CW50RSX)	50	96 -	BR8HS	4322	0,7	BR8HVX	6265	212	BR8HIX	7001	
BW 50 NG (CW50RS;4VA)	50	96 -	BR8HS	4322	0,7	BR8HVX	6265	212	BR8HIX	7001	
BW 50 R (4BX)	50	96 -	BR8HS	4322	0,7	BR8HVX	6265	212	BR8HIX	7001	
CR 50 Z (I)	50		BR7HS	4122	0,5			211	BR7HIX	7067	
CT 50 S (I)	50		BP7HS-10	7829	0,7						
CT 50 SS (I)	50		BP7HS	5111	0,7	BP7HVX	7468		BPR7HIX	5944	
CW 50 R (4BX)	50		BR8HS	4322	0,7	BR8HVX	6265	212	BR8HIX	7001	
Evolis (YE50)(4FW)	50		BR8HS	4322	0,7	BR8HVX	6265	212	BR8HIX	7001	
Forte (YA50R) (3UG)	50		BR8HS	4322	0,7	BR8HVX	6265	212	BR8HIX	7001	
JogR	50		BR8HS	4322	0,6	BR8HVX	6265	212	BR8HIX	7001	
JogRR	50		BR8HS	4322	0,6	BR8HVX	6265	212	BR8HIX	7001	
Jog-Z 50 (I)	50	01.95 -	BP7HS	5111	0,7	BP7HVX	7468		BPR7HIX	5944	
Neo's	50	97 -	BR8HS	4322	0,6	BR8HVX	6265	212	BR8HIX	7001	
Slider (SA09)	50	00 -	BR8HS	4322	0,6	BR8HVX	6265	212	BR8HIX	7001	
Spy 50 (I)	50		BR8HS	4322	0,6	BR8HVX	6265	212	BR8HIX	7001	
Why (SA03)	50	99 -	BR8HS	4322	0,6	BR8HVX	6265	212	BR8HIX	7001	
YA 50 (5AK)	50	97 -	BR7HS	4122	0,7			211	BR7HIX	7067	
Zest/ YE50 (4FW)	50		BR8HS	4322	0,7	BR8HVX	6265	212	BR8HIX	7001	
Evolis (4MU)	80		BR7HS	4122	0,7			211	BR7HIX	7067	
Zest (4MU)(YE80)	80		BR7HS	4122	0,7			211	BR7HIX	7067	
Aerox 100	100	01 -	BR8HS	4322	0,6	BR8HVX	6265	212	BR8HIX	7001	
BW 100 (SB02)	100	99 - 00	BR8HS	4322	0,6	BR8HVX	6265	212	BR8HIX	7001	
BW 100 (SB02)	100	00 -	BR7HS	4122	0,7			211	BR7HIX	7067	
Neos 100 (SB04)	100	00 -	BR8HS	4322	0,6	BR8HVX	6265	212	BR8HIX	7001	
BL 125 (50W)	125	85 - 89	BPR8HS	3725	0,6				BPR8HIX	6742	
Doodo (SE041)	125	01 -	CR8E	1275	0,7	CR8EVX	6487	226	CR8EIX	4218	
Majesty 125 (I)	125		DR8EA	7162	0,6	DR8EVX	6354		DR8EIX	6681	
Maxster 125	125	00 -	CR8E	1275	0,7	CR8EVX	6487	226	CR8EIX	4218	
Teo's (SE041)	125	01 -	CR8E	1275	0,7	CR8EVX	6487	226	CR8EIX	4218	
XC 125 Cygnus	125	04 -	CR7E	4578	0,7			225	CR7EIX	7385	
XC 125 Beluga	125		CR6HSA	2983	0,7				CR6HIX	7274	
XC 125 T (4KY)	125	95 -	CR7E	4578	0,6			225	CR7EIX	7385	
XC 125 Cygnus	125	01.95 -	CR7E	4578	0,7			225	CR7EIX	7385	
XC 125 T (4NB)	125	94 -	CR7E	4578	0,7			225	CR7EIX	7385	
XC 125 (3TE)	125	90 -	CR6HSA	2983	0,7				CR6HIX	7274	
XC 125 TR Cygnus (4NB)	125	96 -	CR7E	4578	0,7			225	CR7EIX	7385	
XC 125 T Cygnus T (4NB)	125	96 -	CR7E	4578	0,6			225	CR7EIX	7385	
XC 125 Cygnus	125	- 94	CR6HSA	2983	0,7				CR6HIX	7274	
YP 125 R Majesty	125	98 -	CR8E	1275	0,7	CR8EVX	6487	226	CR8EIX	4218	
YP 125 R X-MAX	125	06 -	CPR9EA-9	2308	0,9						
XC 150 Fly one (I)	150	01.95 -	CR7E	4578	0,7			225	CR7EIX	7385	
YP 250 DX Majesty ABS (SG021)	250	99 -	DR8EA	7162	0,6	DR8EVX	6354		DR8EIX	6681	
YP 250 Majesty (I)	250		DR8EA	7162	0,6	DR8EVX	6354		DR8EIX	6681	
YP 250 (SG041)	250	00 -	DR8EA	7162	0,6	DR8EVX	6354		DR8EIX	6681	
YP 250 Majesty (4UC)	250		DR8EA	7162	0,6	DR8EVX	6354		DR8EIX	6681	
YP 250 Grand Majesty	250	04 -	CPR7EA-9		0,9						
YP 250 R X-MAX 250	250	05 -	DR8EA	7162	0,7	DR8EVX	6354		DR8EIX	6681	
VP 300 Versity	300	03 -	DR8EA	7162	0,6	DR8EVX	6354		DR8EIX	6681	
T MAX 500	500	04 -	CR7E	4578	0,7			225	CR7EIX	7385	



Order No.



Gold-Palladium



Platin

Order No.



Quick-No.



Iridium



Order No.







ACCESS										
Long 50	50		BR8HSA	5539	0,8	BR8HVX	6265		BR8HIX	7001
Streak 50	50		BR8HSA	5539	0,8	BR8HVX	6265		BR8HIX	7001
Long 100	100		BR8HSA	5539	0,8	BR8HVX	6265		BR8HIX	7001

ADLY										
ATV 50	50		BP7HS	5111	0,6	BP7HVX	7468		BPR7HIX	5944
Buggy 125	125		CR7HSA	4549	0,8				CR7HIX	7544

AEON										
Cobra	50	03 -	BPR7HS	6422	0,8	BPR7HVX	2938	215	BPR7HIX	5944
Minikolt	50	03 -	BPR7HS	6422	0,8	BPR7HVX	2938	215	BPR7HIX	5944
Revo	50	04 -	BPR7HS	6422	0,8	BPR7HVX	2938	215	BPR7HIX	5944
Cobra	100	02 -	BPR7HS	6422	0,8	BPR7HVX	2938	215	BPR7HIX	5944
Revo	100	04 -	BPR7HS	6422	0,8	BPR7HVX	2938	215	BPR7HIX	5944
Cobra Utility	125	02 -	CR7HS	7223	0,8				CR7HIX	7544
Cobra Sport	125	02 -	CR8HSA	2086	0,8	CR8HVX	7236		CR8HIX	7669
Cobra RS 2	125		CR7HS	7223	0,8				CR7HIX	7544
Cobra RS 1	125		CR7HS	7223	0,8				CR7HIX	7544
Overland	125	04 -	CR7HS	7223	0,8				CR7HIX	7544
Cobra Sport	180	02 -	CR8HSA	2086	0,8	CR8HVX	7236		CR8HIX	7669
Cobra RS 2	180	04 -	CR7HSA	4549	0,8				CR7HIX	7544
Cobra RS 1	180		CR7HS	7223	0,8				CR7HIX	7544
Cobra RS 2	180		CR7HS	7223	0,8				CR7HIX	7544
LG 180	180	05 -	CR7HSA	4549	0,8				CR7HIX	7544
Overland	180	04 -	CR7HS	7223	0,8				CR7HIX	7544
Overland II	180	05 -	CR7HSA	4549	0,8				CR7HIX	7544
Utility	180	02 -	CR7HS	7223	0,8				CR7HIX	7544
Cobra 220	220	05 -	CR7HSA	4549	0,6				CR7HIX	7544

ARCTIC CAT										
90	90	02 -	BPR7HS	6422	0,6	BPR7HVX	2938	215	BPR7HIX	5944
250 Quad 4x4	250	01 -	DR7EA	7839	0,6					
300 Quad 2x4 / 4x4	300	99 -	DR7EA	7839	0,6					
300	300	04 -	DR7EA	7839	0,6					
375	375	02 -	CR7E	4578	0,8			225	CR7EIX	7385
400	400	- 98	CR8E	1275	0,7	CR8EVX	6487	226	CR8EIX	4218
400	400	99 - 01	CR6E	6965	0,7					
400	400	03 -	CR7E	4578	0,8			225	CR7EIX	7385
400i	400	04 -	CR7E	4578	0,6			225	CR7EIX	7385
400 TBX	400	04 -	CR7E	4578	0,6			225	CR7EIX	7385
400	400	04 -	CR7E	4578	0,6			225	CR7EIX	7385
454	454	96 - 97	CR8E	1275	0,7	CR8EVX	6487	226	CR8EIX	4218
454	454	98 -	CR6E	6965	0,7					
500	493	99 -	CR6E	6965	0,7					
500 Auto	493	01 -	CR6E	6965	0,7					
500 TBX	500	04 -	CR6E	6965	0,7					
500 TRV	500	04 -	CR6E	6965	0,7					

ARGO										
Vanguard 6X6 B&S OHV V-Twin 16hp	480		BKR5E	7938	0,6				BKR5EIX	6341
Vanguard 2 6X6 B&S OHV V-Twin 16hp	480		BKR5E	7938	0,6				BKR5EIX	6341
Bigfoot 6X6 B&S OHV V-Twin 18hp	570		BKR5E	7938	0,6				BKR5EIX	6341

					Order No.		Platin 	Order No.	Quick-No.	Iridium 	Order No.
ARGO											
Response 8X8	B&S OHV V-Twin 18hp	570		BKR5E	7938	0,6				BKR5EIX	6341
Conquest 6X6	Kawasaki FD620D 20hp	614		BKR5E	7938	0,6				BKR5EIX	6341
Conquest 8X8	Kawasaki FD620D 20hp	617		BMR4A	5728	0,6					
Avenger 8X8	Kohler Aegis LH685	674		BMR4A	5728	0,6					
ATK											
50 Mini Quad		50	01 -	B7HS	5110	0,5	B7HVX	7836	204	BR7HIX	7067
90 Mini Quad		90	01 -	B7HS	5110	0,5	B7HVX	7836	204	BR7HIX	7067
BAROSSA MOTOR											
Mini		50		BPR7HS	6422	0,6	BPR7HVX	2938	215	BPR7HIX	5944
Python		50		BPR7HS	6422	0,8	BPR7HVX	2938	215	BPR7HIX	5944
Python		100		BPR7HS	6422	0,8	BPR7HVX	2938	215	BPR7HIX	5944
Magna		150		DR8EA	7162	0,7	DR8EVX	6354		DR8EIX	6681
Magna		170		DR8EA	7162	0,7	DR8EVX	6354		DR8EIX	6681
Magna		250		DR8EA	7162	0,7	DR8EVX	6354		DR8EIX	6681
BLANEY											
FX70		79	99 -	BP7HS	5111	0,7	BP7HVX	7468		BPR7HIX	5944
FX90		90	00 -	BP7HS	5111	0,7	BP7HVX	7468		BPR7HIX	5944
FX100		100	00 -	BP7HS	5111	0,7	BP7HVX	7468		BPR7HIX	5944
BOMBARDIER											
50 DS		50	02 -	BPR7HS	6422	0,6	BPR7HVX	2938	215	BPR7HIX	5944
50 Quest		50	03 - 03	BPR7HS	6422	0,8	BPR7HVX	2938	215	BPR7HIX	5944
DS 50		50	04 -	BR9ECS	3570	0,5					
Quest 50		50	04 -	BR9ECS	3570	0,5					
90 DS		83	02 -	BPR7HS	6422	0,6	BPR7HVX	2938	215	BPR7HIX	5944
90 DS 4stroke		90	02 -	CR7HSA	4549	0,7				CR7HIX	7544
90 Quest		90	03 - 03	CR7HSA	4549	0,7				CR7HIX	7544
DS 90		90	04 -	BR9ECS	3570	0,5					
Quest 90		90	04 -	BR9ECS	3570	0,5					
175		175	03 -	CR8E	1275	0,7	CR8EVX	6487	226	CR8EIX	4218
Rally 200		176	04 -	BR9ECS	3570	0,5					
200 Rally		200	03 -	CR8E	1275	0,7	CR8EVX	6487	226	CR8EIX	4218
330		330	02 -	DCPR8E	4339	0,9	DCPR8EVX	2265		DCPR8EIX	6546
Outlander 330		330	04 -	BR9ECS	3570	0,5					
400 Outlander		400	03 -	DCPR8E	4339	0,9	DCPR8EVX	2265		DCPR8EIX	6546
Outlander 400		400	04 -	BR9ECS	3570	0,5					
Quest 498		498	03 -	BR9ECS	3570	0,5					
Traxter 498		498	03 -	BR9ECS	3570	0,5					
500		500	02 -	DCPR8E	4339	0,9	DCPR8EVX	2265		DCPR8EIX	6546
500 Traxter 7401		500	99 - 02	DR8EA	7162	0,7	DR8EVX	6354		DR8EIX	6681
500 Traxter 7414		500	98 - 02	DR8EA	7162	0,7	DR8EVX	6354		DR8EIX	6681
Quest 644		644	03 -	BR9ECS	3570	0,5					
650 Quest		650	02 - 03	DCPR8E	4339	0,9	DCPR8EVX	2265		DCPR8EIX	6546
650 Traxter DS / DR		650	00 -	DR8EA	7162	0,7	DR8EVX	6354		DR8EIX	6681
650 DS 653		653	03 -	BR9ECS	3570	0,5					
BOSS											
X2S1-90R		90		BP6HS	4511	0,6	BP6HVX	4635		BPR6HIX	4085
X4SZ-150R		155		BP6HS	4511	0,6	BP6HVX	4635		BPR6HIX	4085



Order No.



Gold-Palladium



Order No.







Quick-No.

Iridium



Order No.

BRISTER										
Brister's Chuck Wagon 11.0 HP Honda OHV GX340			BPR6ES-11	4824	1,1	BPR6EVX-11	4233		BPR6EIX-11	3903
F1-25 5 HP OHV Tecumseh			BR6ES	4922	0,6					
F1-265, F1-265E 6.5 HP OHV Tecumseh			BR6ES	4922	0,6					
F2-265, F2-265E 6.5 HP OHV Tecumseh			BR6ES	4922	0,6					
The Bug 3 HP Tecumseh			BR6S	3522	0,6					
The Scorpion 6.5 HP OHV Tecumseh			BR6ES	4922	0,6					
The Scorpion S 11.0 HP OHV Tecumseh			BR6ES	4922	0,6					
The Scorpion S 6.5 HP OHV Tecumseh			BR6ES	4922	0,6					
The Spider 5 HP OHV Tecumseh			BR6ES	4922	0,6					
The Spider X 6.5 HP OHV Tecumseh			BR6ES	4922	0,6					
The Stinger 5 HP OHV Tecumseh			BR6ES	4922	0,6					
BUSH HOG										
Trail Hunter 16.0 hp B&S			BKR5E	7938	0,6				BKR5EIX	6341
Trail Hunter 20.0 hp Honda			BPR6ES	7822	0,8	BPR6EVX	6764		BPR6EIX	6637
Trail Hunter 24.0 hp Honda			ZGR5A	5839	0,6					
CANNONDALE										
FX 400	432	00 -	CR9EK	4548	0,7			230	CR9EIX	3521
440 Moto	440	02 -	CR9EK	4548	0,7			230	CR9EIX	3521
Blaze	440	02 -	CR9EK	4548	0,7			230	CR9EIX	3521
Cannibal	440	02 -	CR9EK	4548	0,7			230	CR9EIX	3521
Glamis	440	03 -	CR9EK	4548	0,7			230	CR9EIX	3521
Speed	440	02 -	CR9EK	4548	0,7			230	CR9EIX	3521
CARTER										
3.5 HP B&S			BR2LM	5798	0,6			310		
5.0 HP B&S			BR2LM	5798	0,6			310		
5.0 HP TECUMSEH OHH50			BP6ES	7811	0,8	BP6EVX	5832		BPR6EIX	6637
5.5 HP HONDA GX160			BPR6ES	7822	0,8	BPR6EVX	6764		BPR6EIX	6637
6.0 HP TECUMSEH OHH60			BR6ES	4922	0,7					
6.5 HP OHV Tecumseh			BR6ES	4922	0,6					
6.5 HP Tecumseh OHH65			BP6ES	7811	0,8	BP6EVX	5832		BPR6EIX	6637
8.0 HP B&S			BR2LM	5798	0,6			310		
8.0 HP TECUMSEH			BR4LM	4133	0,6					
8.0 HP TECUSEH			BR6S	3522	0,6					
10.0 HP TECUMSEH			BR4LM	4133	0,6					
SMC ENGINE			CR7HSA	4549	0,8				CR7HIX	7544
CPI										
200	50	03 -	BR7ES	5122	0,8	BR7EVX	4556			
Carb 50	50	03 -	BR8HSA	5539	0,8	BR8HVX	6265		BR8HIX	7001
Dirt Demon	50	02 -	BR8HSA	5539	0,8	BR8HVX	6265		BR8HIX	7001
Carb 100	100	03 -	BR8HSA	5539	0,8	BR8HVX	6265		BR8HIX	7001
Dirt Demon	100	02 -	BR8HSA	5539	0,8	BR8HVX	6265		BR8HIX	7001
CUB CADET										
4x2 9.5 hp Kawasaki			BPR5ES	7422	0,7	BPR5EVX	4875		BPR5EIX	6597
4x2 18.0 hp Honda V-Twin OHV			ZGR5A	5839	0,7					
6x4 20.0 hp Honda V-Twin OHV			ZGR5A	5839	0,7					

					Order No.		Platin 	Order No.	Quick-No.	Iridium 	Order No.
DAREN											
50		50	00 -	BPR7HS	6422	0,8	BPR7HVX	2938	215	BPR7HIX	5944
100		100	00 -	BPR7HS	6422	0,8	BPR7HVX	2938	215	BPR7HIX	5944
125		125	00 -	DR8EA	7162	0,7	DR8EVX	6354		DR8EIX	6681
150		150	00 -	DR8EA	7162	0,7	DR8EVX	6354		DR8EIX	6681
DAZON											
Stinger 50		50		CR7HSA	4549	0,8				CR7HIX	7544
Raider Classic 150R		150		CR7HSA	4549	0,7				CR7HIX	7544
Raider Max 150R		150		CR8E	1275	0,7	CR8EVX	6487	226	CR8EIX	4218
Buggy 175		175		dpr8ea-8	4929	0,9	dpr8evx-9	2872		dpr8eix-9	2202
Raider Max 175R		175		CR8E	1275	0,7	CR8EVX	6487	226	CR8EIX	4218
Raider Max 250R		250		CR8E	1275	0,7	CR8EVX	6487	226	CR8EIX	4218
DERBI											
170		170		DR8EA	7162	0,7	DR8EVX	6354		DR8EIX	6681
250		250		CR8HS	7423	0,7	CR8HVX	7236		CR8HIX	7669
DINLI											
Cobia DL-503		50		BPR7HS	6422	0,6	BPR7HVX	2938	215	BPR7HIX	5944
Diamond Back DL601-50 2-Stroke		50		BPR7HS	6422	0,8	BPR7HVX	2938	215	BPR7HIX	5944
Dino		50	02 -	BPR7HS	6422	0,6	BPR7HVX	2938	215	BPR7HIX	5944
Dino DL501-50 2-Stroke		50		BPR7HS	6422	0,8	BPR7HVX	2938	215	BPR7HIX	5944
Helix		50	04 -	BPR7HS	6422	0,8	BPR7HVX	2938	215	BPR7HIX	5944
JP DL502-51 2-Stroke		50		BPR7HS	6422	0,6	BPR7HVX	2938	215	BPR7HIX	5944
T-Rex		50	03 -	BPR7HS	6422	0,8	BPR7HVX	2938	215	BPR7HIX	5944
Beast DL602-90 2-Stroke		90		BPR7HS	6422	0,8	BPR7HVX	2938	215	BPR7HIX	5944
Diamond Back DL601-90 2-Stroke		90		BPR7HS	6422	0,8	BPR7HVX	2938	215	BPR7HIX	5944
Helix DL603-90 2-Stroke		90		BPR7HS	6422	0,7	BPR7HVX	2938	215	BPR7HIX	5944
T-Rex 100		100		BP6HS	4511	0,6	BP6HVX	4635		BPR6HIX	4085
Diablo DL604-150 4-Stroke		150		C7HSA	4629	0,6	C7HVX	4533		CR7HIX	7544
Enforcer DL605-150 4-Stroke		150		C7HSA	4629	0,7	C7HVX	4533		CR7HIX	7544
Helix DL603-150 4-Stroke		150		C7HSA	4629	0,7	C7HVX	4533		CR7HIX	7544
DRR											
DRR 50		50	04 -	BP7HS	5111	0,7	BP7HVX	7468		BPR7HIX	5944
DRR 90		90	04 -	BP7HS	5111	0,7	BP7HVX	7468		BPR7HIX	5944
DRR 90 GT		90	04 -	C7HSA	4629	0,7	C7HVX	4533		CR7HIX	7544
E.ATV											
siehe /see KTM											
EAT RACING											
Evolution 510		510		DCPR8E	4179	0,6	DCPR8EVX	2265		DCPR8EIX	6546
Explorer 625		625		DR8EA	7162	0,6	DR8EVX	6354		DR8EIX	6681
Extreme 950		950		CR8EK	3478	0,7				CR8EIX	4218
Energia 992		992		DCPR8E	4179	0,6	DCPR8EVX	2265		DCPR8EIX	6546
ERING											
Tornado 50		50		BP7HS	5111	0,7	BP7HVX	7468		BPR7HIX	5944
E-TON											
Viper Juior		40	03 -	BPM7A	7321	0,6			305		



Order No.



Gold-Palladium



Order No.

Quick-No.

Iridium



Order No.

E-TON

Viper	50	02 -	BPR7HS	6422	0,6	BPR7HVX	2938	215	BPR7HIX	5944
Sierra Ranger	90	03 -	BPR7HS	6422	0,8	BPR7HVX	2938	215	BPR7HIX	5944
Viper	90	02 -	BPR7HS	6422	0,8	BPR7HVX	2938	215	BPR7HIX	5944
Yukon	150	99 -	C7HSA	4629	0,6	C7HVX	4533		CR7HIX	7544

FOX

50	50	00 -	BPR7HS	6422	0,8	BPR7HVX	2938	215	BPR7HIX	5944
50 VR Sport	50	01 -	BPR7HS	6422	0,8	BPR7HVX	2938	215	BPR7HIX	5944
90 MT	90	99 -	CR7HSA	4549	0,8				CR7HIX	7544
100	100	00 -	BPR7HS	6422	0,8	BPR7HVX	2938	215	BPR7HIX	5944

G+G

QUAD not Twinspark	1130	03 -	BKR7EKC	7354					BKR7EIX	2667
--------------------	------	------	---------	------	--	--	--	--	---------	------

GAS GAS







300 Wild	300	02 -	BR8EG	3130	0,5					
450 Wild	450	02 -	CR8E	1275	0,7	CR8EVX	6487	226	CR8EIX	4218







HERKULES







ATV 50 VS	50	04 -	BP7HS	5111	0,7	BP7HVX	7468		BPR7HIX	5944
ATV 50 VG	50	04 -	BP7HS	5111	0,7	BP7HVX	7468		BPR7HIX	5944
ATV 50 RS XXL	50	03.05 -	BPR7HS	6422	0,8	BPR7HVX	2938	215	BPR7HIX	5944
ATV 100 V	100	04 -	BPR7HS	6422	0,8	BPR7HVX	2938	215	BPR7HIX	5944
ATK 125 R Go Kart	125	04 -	C7HSA	4629	0,7	C7HVX	4533		CR7HIX	7544
ATV 150 U	150	04 -	CR8E	1275	0,7	CR8EVX	6487	226	CR8EIX	4218
ATV 150 S	150	04 -	CR8E	1275	0,7	CR8EVX	6487	226	CR8EIX	4218
ATV 300 U	300	04 -	DR8EA	7162	0,7	DR8EVX	6354		DR8EIX	6681
ATV 300 S	300	04 -	DR8EA	7162	0,7	DR8EVX	6354		DR8EIX	6681

HONDA

TRX 70	70		CR7HS	7223	0,7				CR7HIX	7544
ATC 90	90	70 - 78	D8HA	7112	0,6					
TRX 90	90	93 - 94	CR6HSA	2983	0,7				CR6HIX	7274
TRX 90	90	95 -	CR7HSA	4549	0,7				CR7HIX	7544
ATC 125 M	125		DR8ESL	2923	0,6	DR8EVX	6354	218	DR8EIX	6681
TRAX 125	125		DR8ESL	2923	0,7	DR8EVX	6354	218	DR8EIX	6681
TRX 125	125		DR8ESL	2923	0,7	DR8EVX	6354	218	DR8EIX	6681
ATC 185	185		D8EA	2120	0,7	D8EVX	2850	216	DR8EIX	6681
ATC 185 S	185		DR8ESL	2923	0,6	DR8EVX	6354	218	DR8EIX	6681
ATC 200	200		DR8ESL	2923	0,6	DR8EVX	6354	218	DR8EIX	6681
TRX 200 D	200	92 -	DR8ESL	2923	0,6	DR8EVX	6354	218	DR8EIX	6681
TRX 200 SX	200		DR8ESL	2923	0,7	DR8EVX	6354	218	DR8EIX	6681
ATC 250 ES /SX	250	85 -	DR8ESL	2923	0,7	DR8EVX	6354	218	DR8EIX	6681
ATC 250 R	250		BR9ES	5722	0,8	BR9EVX	1265	208	BR9EIX	3981
FL 250	250		BR9ES	5722	0,8	BR9EVX	1265	208	BR9EIX	3981
TRAX 250	250		DR8ESL	2923	0,6	DR8EVX	6354	218	DR8EIX	6681
TRX 250	250		DR8ESL	2923	0,6	DR8EVX	6354	218	DR8EIX	6681
TRX 250 EX	250	05 -	DPR8EA-9	4929	0,9	DPR8EVX-9	2872	221	DPR8EIX-9	2202
TRX 250 R	250		BR9ES	5722	0,6	BR9EVX	1265	208	BR9EIX	3981
TRX 250 X	250		DR8ESL	2923	0,7	DR8EVX	6354	218	DR8EIX	6681
TRX 300	300	93 -	DPR8EA-9	4929	0,9	DPR8EVX-9	2872	221	DPR8EIX-9	2202
TRX 300 EX	300	93 -	DR8ESL	2923	0,6	DR8EVX	6354	218	DR8EIX	6681

					Order No.		Platin 	Order No.	Quick-No.	Iridium 	Order No.
HONDA											
TRX 300 FW	300	93 -	DPR8EA-9	4929	0,9	DPR8EVX-9	2872	221	DPR8EIX-9	2202	
TRX 300 N	300	92 -	DPR8EA-9	4929	0,9	DPR8EVX-9	2872	221	DPR8EIX-9	2202	
TRX 300 EX	300	05 -	DR8ESL	2923	0,7	DR8EVX	6354	218	DR8EIX	6681	
ATC 350 X	350		DR8ESL	2923	0,7	DR8EVX	6354	218	DR8EIX	6681	
FL 350 R	350		BR9ES	5722	0,8	BR9EVX	1265	208	BR9EIX	3981	
TRX 350 FE	350	05 -	DPR7EA-9	5129	0,9	DPR7EVX-9	7682	220	DPR7EIX-9	7803	
TRX 350	350	93 -	DR8ESL	2923	0,6	DR8EVX	6354	218	DR8EIX	6681	
TRX 350 FM	350	05 -	DPR7EA-9	5129	0,9	DPR7EVX-9	7682	220	DPR7EIX-9	7803	
TRX 350 TE	350	05 -	DPR7EA-9	5129	0,9	DPR7EVX-9	7682	220	DPR7EIX-9	7803	
TRX 350 TM	350	05 -	DPR7EA-9	5129	0,9	DPR7EVX-9	7682	220	DPR7EIX-9	7803	
TRX 400 FA	400	05 -	DPR8EA-9	4929	0,9	DPR8EVX-9	2872	221	DPR8EIX-9	2202	
TRX 400 FGA	400	05 -	DPR8EA-9	4929	0,9	DPR8EVX-9	2872	221	DPR8EIX-9	2202	
TRX 400 FW	400	95 -	DPR7EA-9	5129	0,9	DPR7EVX-9	7682	220	DPR7EIX-9	7803	
TRX 450 / R	450	05 -	DPR7EA-9	5129	0,9	DPR7EVX-9	7682	220	DPR7EIX-9	7803	
TRX 500	500	05 -			0,9				IJR7A-9	7901	
TRX 500 FA	500	02 -			0,9				IJR7A-9	7901	
Rincon TRX 650	650	01.04 -			1,1				IFR5L11	6502	
TRX 650 FGA	650	05 -			1,1				IFR5L11	6502	
TRX 650 FA	650	05 -			1,1				IFR5L11	6502	
HUSQVARNA											
QM 450	450	05 -	CR8EB	7784	0,6	CR8EVX	6487		CR8EIX	4218	
HYOSUNG											
50	50	03 -	BP6HS	4511	0,7	BP6HVX	4635		BPR6HIX	4085	
90	50	03 -	BPR7HS	6422	0,8	BPR7HVX	2938	215	BPR7HIX	5944	
WOW 50	50	04 -	BP7HS	5111	0,7	BP7HVX	7468		BPR7HIX	5944	
WOW 90	90	04 -	BP7HS	5111	0,7	BP7HVX	7468		BPR7HIX	5944	
JOHN DEERE											
Gator Kawasaki OHV 18.0 hp			BMR6A	7421	0,6			306			
Gator 6x4			BMR2A-10	4452	0,9						
Gator Kawasaki FD620D 20.0 hp			BMR2A-10	4452	0,9						
Gator 4x2			BPR6ES	7822	0,8	BPR6EVX	6764		BPR6EIX	6637	
Gator Kawasaki 10.0 hp			B5HS	4210	0,6						
Gator Kawasaki FE250D 8.0 hp	250		BPR5ES	7422	0,7	BPR5EVX	4875		BPR5EIX	6597	
Gator Kawasaki FE290D 9.5 hp	290		BPR5ES	7422	0,7	BPR5EVX	4875		BPR5EIX	6597	
Buck	500		DR8EA	7162	0,7	DR8EVX	6354		DR8EIX	6681	
Trail Buck	500		DCPR8E	4339	0,9	DCPR8EVX	2265		DCPR8EIX	6546	
Trail Buck	650		DCPR8E	4339	0,9	DCPR8EVX	2265		DCPR8EIX	6546	
KARCHER											
KM 170-8	170		DR8EA	7162	0,7	DR8EVX	6354		DR8EIX	6681	
KM 250-10	250		CR8HS	7423	0,7	CR8HVX	7236		CR8HIX	7669	
KM 250-11	250		CR8HS	7423	0,7	CR8HVX	7236		CR8HIX	7669	
KM 250-9	250		CR8HS	7423	0,7	CR8HVX	7236		CR8HIX	7669	
KAWASAKI											
KFX 50 A (SQ)	50	03 -	BPR4HS	7823	0,7						
KFX 80	80	04 -	BPR4HS	7823	0,6						
KLF 185	185		DR8ES	5423	0,7	DR8EVX	6354	217	DR8EIX	6681	
KLF 220	220	88 - 02	DR8ES	5423	0,7	DR8EVX	6354	217	DR8EIX	6681	

				Order No.		Platin 	Order No.	Quick-No.	Iridium 	Order No.
KAWASAKI										
KDX 250	250		BR8ES	5422	0,8	BR8EVX	1262	207	BR8EIX	5044
KDX 250	250	91 -	BR9ES	5722	0,8	BR9EVX	1265	208	BR9EIX	3981
KDX 250 SR	250	92 -	BR8ES	5422	0,8	BR8EVX	1262	207	BR8EIX	5044
KLF 250 A	250	02 -	DR8ES	5423	0,7	DR8EVX	6354	217	DR8EIX	6681
KEF 300 A&B (SQ)	300	95 -	DR7EA	7839	0,7					
KLF 300	300	88 -	BR8ES	5422	0,8	BR8EVX	1262	207	BR8EIX	5044
KVF 360 A &B	360	02 -	DPR8EA-9	4929	0,9	DPR8EVX-9	2872	221	DPR8EIX-9	2202
KFX 400	400	03 -	CR7E	4578	0,8			225	CR7EIX	7385
KFX 400 A (SQ)	400	03 -	CR8E	1275	0,7	CR8EVX	6487	226	CR8EIX	4218
KLF 400 B	400	93 - 99	DPR8EA-9	4929	0,9	DPR8EVX-9	2872	221	DPR8EIX-9	2202
KVF 400 C&D	400	99 - 02	DPR8EA-9	4929	0,9	DPR8EVX-9	2872	221	DPR8EIX-9	2202
KXF 400 A	400	03 -	CR8EB	7784	0,6	CR8EVX	6487		CR8EIX	4218
KVF 650 4X4	650	05 -	CR7E	4578	0,8			225	CR7EIX	7385
KVF 650 A	650	00 -	CR7E	4578	0,8			225	CR7EIX	7385
KFV 700	700	04 -	CR7E	4578	0,8			225	CR7EIX	7385
KFX 700 Quad	700	04 -	CR7E	4578	0,8			225	CR7EIX	7385
KSV 700	700	04 -	CR7E	4578	0,8			225	CR7EIX	7385
KVF 750	750	05 -	CR7E	4578	0,8			225	CR7EIX	7385
KOLPIN										
50	50		BR8HSA	5539	0,8	BR8HVX	6265		BR8HIX	7001
90	90		BR8HSA	5539	0,8	BR8HVX	6265		BR8HIX	7001
KREIDLER										
Mini Mustang	50	05 -	BPR7HS	6422	0,8	BPR7HVX	2938	215	BPR7HIX	5944
Mustang	50	05 -	BPR7HS	6422	0,8	BPR7HVX	2938	215	BPR7HIX	5944
F-Kart 100	100	05 -	BPR7HS	6422	0,8	BPR7HVX	2938	215	BPR7HIX	5944
Mustang 170	170	05 -	DR8EA	7162	0,7	DR8EVX	6354		DR8EIX	6681
Mustang 200	170	05 -	DR8EA	7162	0,7	DR8EVX	6354		DR8EIX	6681
Mustang 250	250	05 -	CR8HS	7423	0,7	CR8HVX	7236		CR8HIX	7669
KYMCO										
MX 50	50	01 -	BR8HSA	5539	0,5	BR8HVX	6265		BR8HIX	7001
MXér 50	50	05 -	BR8HSA	5539	0,5	BR8HVX	6265		BR8HIX	7001
MX 150	150	01 -	DR8EA	7162	0,7	DR8EVX	6354		DR8EIX	6681
KXR 250	250	01 -	DPR7EA-9	5129	0,9	DPR7EVX-9	7682	220	DPR7EIX-9	7803
MXU 250	250	05 -	DPR7EA-9	5129	0,9	DPR7EVX-9	7682	220	DPR7EIX-9	7803
Maxxer 300	300	05 -	DPR7EA-9	5129	0,9	DPR7EVX-9	7682	220	DPR7EIX-9	7803
MXU 500 4x4	500	06 -	CR8E	1275	0,6			226	CR8EIX	4218
LEM										
Cayman	50	97 - 04	BR8HS	4322	0,6	BR8HVX	6265	212	BR8HIX	7001
Condor	50	97 - 04	BR8HS	4322	0,6	BR8HVX	6265	212	BR8HIX	7001
LINHAI										
260	260	05 -	DR8EA	7162	0,7	DR8EVX	6354		DR8EIX	6681
MANCO										
Miny Indy 5.0 hp Subaru Engine	50		BR6HS	3922	0,7			209	BR6HIX	3419
Stock Car 4.0 hp Subaru Engine	50		BR6HS	3922	0,7			209	BR6HIX	3419
ZSR-50	50		BPR7HS	6422	0,8	BPR7HVX	2938	215	BPR7HIX	5944
ZSR-90	90		BPR7HS	6422	0,8	BPR7HVX	2938	215	BPR7HIX	5944

					Order No.		Platin 	Order No.	Quick-No. 	Iridium	Order No.
MANCO											
Bandit Kart 4.0 hp Subaru Engine	126		BR6HS	3922	0,6				209	BR6HIX	3419
Critter Kart 5.0 hp Subaru Engine	126		BR6HS	3922	0,7				209	BR6HIX	3419
Eliminator Kart 5.0 hp Subaru Engine	126		BR6HS	3922	0,6				209	BR6HIX	3419
Force Five Kart 5.0 hp Subaru Engine	126		BR6HS	3922	0,6				209	BR6HIX	3419
Quicksilver Kart 5.0 hp Subaru Engine	126		BR6HS	3922	0,7				209	BR6HIX	3419
Eliminator Kart 6.5 hp Subaru Engine	169		BR6HS	3922	0,7				209	BR6HIX	3419
EZ Rider 6.5 hp Subaru Engine	169		BR6HS	3922	0,7				209	BR6HIX	3419
Aerforce Kart 7.0 hp Subaru Engine	211		BR6HS	3922	0,7				209	BR6HIX	3419
Intruder Kart 7.0 hp Subaru Engine	211		BR6HS	3922	0,7				209	BR6HIX	3419
8260E	260		DR8EA	7162	0,7	DR8EVX	6354			DR8EIX	6681
Aerforce Kart 10.0 hp Robin Subaru Engine	265		BR6HS	3922	0,7				209	BR6HIX	3419
Robin Subaru Engine											
XTK-713E 13.5 hp Robin Subaru Engine	404		BR6HS	3922	0,6				209	BR6HIX	3419
618 Super Deuce 18.0 hp Honda V-Twin OHV	450		BPR5ES	7422	0,7	BPR5EVX	4875			BPR5EIX	6597
MOTOR TEK											
MT 125	125	05 -	CR7HSA	4549	0,8					CR7HIX	7544
MT 175	175	05 -	DR8EA	7162	0,7	DR8EVX	6354			DR8EIX	6681
MSA											
Fox	50	00 -	BR8HSA	5539	0,8	BR8HVX	6265			BR8HIX	7001
Mini Fox	50	00 -	BM6A	5921	0,6						
Sport	50	00 -	BR8HSA	5539	0,8	BR8HVX	6265			BR8HIX	7001
Fox	90	00 -	CR7HSA	4549	0,6					CR7HIX	7544
Fox	100	00 -	BR8HSA	5539	0,8	BR8HVX	6265			BR8HIX	7001
Sport	100	00 -	BR8HSA	5539	0,8	BR8HVX	6265			BR8HIX	7001
MZ											
ATV 50	50	03 -	BP6HS	4511	0,6	BP6HVX	4635			BPR6HIX	4085
ATV 100	100	03 -	BP6HS	4511	0,6	BP6HVX	4635			BPR6HIX	4085
MT 125 Cobra	125	05 -	C7HSA	4629	0,6	C7HVX	4533			CR7HIX	7544
KX 150	150	05 -	CR7E	4578	0,6			225		CR7EIX	7385
VRS 150	150	05 -	CR7E	4578	0,6			225		CR7EIX	7385
PANDA											
KD 50 A	50	00 - 01	CR6HSA	2983	0,7					CR6HIX	7274
KD 80 A	80	00 - 01	CR6HSA	2983	0,7					CR6HIX	7274
KD 125 A	125	00 - 01	CR6HSA	2983	0,7					CR6HIX	7274
PGO											
110	110	03 -	BPR7HS	6422	0,8	BPR7HVX	2938	215		BPR7HIX	5944
151	150	03 -	CR7HSA	4549	0,6					CR7HIX	7544
POLARIS											
UTV 2X4 24 PS 4Takt			BKR5E	7938	0,6					BKR5EIX	6341
UTV 4X4 30 PS 4Takt			BKR5E	7938	0,6					BKR5EIX	6341
UTV 6X6 30 PS 4Takt			BKR5E	7938	0,6					BKR5EIX	6341
Predator AR03-01	50	03 -	BPR7HS	6422	0,8	BPR7HVX	2938	215		BPR7HIX	5944
Youth Scrambler AR03	50	01 - 03	BPR7HS	6422	0,8	BPR7HVX	2938	215		BPR7HIX	5944
Youth Predator AR07	90	03 -	BPR7HS	6422	0,8	BPR7HVX	2938	215		BPR7HIX	5944
Youth Scrambler AR07	90	01 - 02	BPR7HS	6422	0,8	BPR7HVX	2938	215		BPR7HIX	5944



Order No.



Gold-Palladium



Platin

Order No.

Quick-No.



Iridium

Order No.

POLARIS

Youth Sportsman AR07	90	01 -	BPR7HS	6422	0,8	BPR7HVX	2938	215	BPR7HIX	5944
Phönix 200	200	05 -	CR7HSA	4549	0,6				CR7HIX	7544
Big Boss	250	89 - 93	BR8ES	5422	0,6	BR8EVX	1262	207	BR8EIX	5044
Cyclone	250	88 - 89	BR8ES	5422	0,6	BR8EVX	1262	207	BR8EIX	5044
Scrambler	250	89 - 93	BR8ES	5422	0,6	BR8EVX	1262	207	BR8EIX	5044
Trail Blazer	250	90 -	BR8ES	5422	0,6	BR8EVX	1262	207	BR8EIX	5044
Trail Boss	250	85 -	BR8ES	5422	0,6	BR8EVX	1262	207	BR8EIX	5044
Xplorer EC25	250	00 - 02	BR8ES	5422	0,5	BR8EVX	1262	207	BR8EIX	5044
Xplorer 300	283	94 -	BR8ES	5422	0,6	BR8EVX	1262	207	BR8EIX	5044
Xpress 300	283	94 -	BR8ES	5422	0,6	BR8EVX	1262	207	BR8EIX	5044
Xplorer EC28	300	94 - 00	BR8ES	5422	0,5	BR8EVX	1262	207	BR8EIX	5044
Xpress EC28	300	94 - 00	BR8ES	5422	0,5	BR8EVX	1262	207	BR8EIX	5044
Magnum 330 4x4	330	05 -	BKR6ES	3783	0,6	BKR6EVX	3539		BKR6EIX	6418
Trail Boss 330	330	05 -	BKR6ES	3783	0,6	BKR6EVX	3539		BKR6EIX	6418
Sportsman 335	334	99 -	BKR7E	6097	0,6				BKR7EIX	2667
Big Boss	350	93 -	BR8ES	5422	0,6	BR8EVX	1262	207	BR8EIX	5044
Trail Boss	350	90 - 93	BR8ES	5422	0,6	BR8EVX	1262	207	BR8EIX	5044
Trail Boss EC35	350	90 - 93	BR8ES	5422	0,5	BR8EVX	1262	207	BR8EIX	5044
Big Boss 400L (6X6)	379	95 - 97	BR8ES	5422	0,6	BR8EVX	1262	207	BR8EIX	5044
Scambler 400 (4X4)	379	94 -	BR8ES	5422	0,6	BR8EVX	1262	207	BR8EIX	5044
Sport 400	379	98 -	BR8ES	5422	0,6	BR8EVX	1262	207	BR8EIX	5044
Sport ATV	379	95 - 97	BR8ES	5422	0,6	BR8EVX	1262	207	BR8EIX	5044
Sportsman 4x4	379	94 - 97	BR8ES	5422	0,6	BR8EVX	1262	207	BR8EIX	5044
Xplorer 400/400L 4x4	379	94 -	BR8ES	5422	0,6	BR8EVX	1262	207	BR8EIX	5044
Xpress 400 L 2x4	379	96 - 97	BR8ES	5422	0,6	BR8EVX	1262	207	BR8EIX	5044
Big Boss EC38	400	95 - 98	BR8ES	5422	0,5	BR8EVX	1262	207	BR8EIX	5044
Scrambler EC38	400	94 - 02	BR8ES	5422	0,5	BR8EVX	1262	207	BR8EIX	5044
Sport EC38	400	95 - 99	BR8ES	5422	0,5	BR8EVX	1262	207	BR8EIX	5044
Sportsman EC38	400	94 - 97	BR8ES	5422	0,5	BR8EVX	1262	207	BR8EIX	5044
Sportsman EC38	400	03 -	BKR5E	7938	0,6				BKR5EIX	6341
Trail Blazer EC38	400	03 -	BR8ES	5422	0,5	BR8EVX	1262	207	BR8EIX	5044
Xplorer EC38	400	94 - 02	BR8ES	5422	0,5	BR8EVX	1262	207	BR8EIX	5044
Xpress EC38	400	96 - 97	BR8ES	5422	0,5	BR8EVX	1262	207	BR8EIX	5044
Expedition EH42	425	01 - 03	BKR5E	7938	0,6				BKR5EIX	6341
Magnum (2X4)	425	95 -	BKR5E	7938	0,6				BKR5EIX	6341
Magnum (4X4)	425	95 -	BKR5E	7938	0,6				BKR5EIX	6341
Magnum (6X6)	425	96 - 97	BKR5E	7938	0,6				BKR5EIX	6341
Ranger EH42	425	02 -	BKR5E	7938	0,6				BKR5EIX	6341
Sportsman EH42	425	01 - 04	BKR5E	7938	0,6				BKR5EIX	6341
ATP 500	500	05 -	BKR6ES	3783	0,6	BKR6EVX	3539		BKR6EIX	6418
Big Boss 500 (6X6)	500	98 -	BKR5E	7938	0,6				BKR5EIX	6341
Hauler Light Utility EH50	500	02 - 03	BKR5E	7938	0,6				BKR5EIX	6341
Magnum 500	500	99 -	BKR5E	7938	0,6				BKR5EIX	6341
Predator ES 50	500	03 -	DCPR8E	4339	0,9	DCPR8EVX	2265		DCPR8EIX	6546
Predator 500	500	05 -	DCPR8E	4339	0,9	DCPR8EVX	2265		DCPR8EIX	6546
Pro ATV EH50	500	02 - 03	BKR5E	7938	0,6				BKR5EIX	6341
Ranger	500	99 -	BKR5E	7938	0,6				BKR5EIX	6341
Scrambler 500	500	98 -	BKR5E	7938	0,6				BKR5EIX	6341
Sportsman 500	500	96 - 04	BKR5E	7938	0,6				BKR5EIX	6341
Sportsman 6x6	500	05 -	BKR6ES	3783	0,6	BKR6EVX	3539		BKR6EIX	6418
Task Force Utility EH50	500	02 - 03	BKR5E	7938	0,6				BKR5EIX	6341
Xplorer 500	500	97 -	BKR5E	7938	0,6				BKR5EIX	6341



Order No.



Gold-Palladium



Platin

Order No.

Quick-No.

Iridium



Order No.

POLARIS

Sportsmann 600	600	03 -	BKR7E	6097	0,6				BKR7EIX	2667
Ranger TM	653	04 -	BPR4ES	7222	0,7				BPR4EVX	3436
Sportsmann 700	700	03 -	BKR7E	6097	0,6				BKR7EIX	2667
Sportsman 800	800	05 -	BKR7E	6097	0,6				BKR7EIX	2667

SACHS







4rock 50	50	06 -	BPR7HS	6422	0,7	BPR7HVX	2938	215	BPR7HIX	5944
T-Rex 50	50	06 -	BPR7HS	6422	0,6	BPR7HVX	2938	215	BPR7HIX	5944
Helix 100	100	06 -	BPR7HS	6422	0,6	BPR7HVX	2938	215	BPR7HIX	5944
T-Rex 100	100	06 -	BPR7HS	6422	0,6	BPR7HVX	2938	215	BPR7HIX	5944
4rock 110	110	06 -	BPR7HS	6422	0,7	BPR7HVX	2938	215	BPR7HIX	5944
4rock 150	150	06 -	C7HSA	4629	0,7	C7HVX	4533		CR7HIX	7544
Helix 150	150	06 -	C7HSA	4629	0,6	C7HVX	4533		CR7HIX	7544
4rock 250	250	06 -	CR8HS	7423	0,7	CR8HVX	7236		CR8HIX	7669

SUZUKI

LT 50	50		BPR4HS	7823	0,7					
LT 80	80		BPR7HS	6422	0,7	BPR7HVX	2938	215	BPR7HIX	5944
LT 160 E	160	- 92	D7EA	7912	0,7	D7EVX	2734			
LT 160 E	160	93 -	DPR7EA-9	5129	0,9	DPR7EVX-9	7682	220	DPR7EIX-9	7803
LT 160 F	160	93 -	DP7EA-9	5629	0,9	DPR7EVX-9	7682		DPR7EIX-9	7803
LT-F 160	160	95 -	DP7EA-9	5629	0,9	DPR7EVX-9	7682		DPR7EIX-9	7803
LT 230 E	230	93 -	D7EA	7912	0,7	D7EVX	2734			
LT 230 E/F	230		DR7ES	3123	0,7					
LT 230 GE	230		D7EA	7912	0,7	D7EVX	2734			
LT 250 4WD/F4WD	250	- 94	DR7ES	3123	0,7					
LT 250 E/EF	250	93 -	D8EA	2120	0,7	D8EVX	2850	216	DR8EIX	6681
LT 250 EF	250		DR8ESL	2923	0,7	DR8EVX	6354	218	DR8EIX	6681
LT 250 R	250				0,6	BR8EVX	1262		BR8EIX	5044
LT 250 R	250	93 -			0,6	B9EGV	5827			
LT 250 S	250		DPR7EA-9	5129	0,9	DPR7EVX-9	7682	220	DPR7EIX-9	7803
LTF 250	250	93 -	DR7ES	3123	0,7					
LTF 250	250	- 94	DR7ES	3123	0,7					
LTF 250	250	95 -	D7EA	7912	0,6	D7EVX	2734			
LT-4 WDX	280	95 -	D7EA	7912	0,6	D7EVX	2734			
LT-4WD / F4WD	280	95 -	DR7EA	7839	0,6					
LT-F4WDX	280	93 - 94	DR7ES	3123	0,7					
LT-300	300	87 - 89	D8EA	2120	0,6	D8EVX	2850	216	DR8EIX	6681
LT-F 300	300	99 -	D7EA	7912	0,6	D7EVX	2734			
LT-A 400F	400	02 -	CR7E	4578	0,6			225	CR7EIX	7385
LT-A 400	400	02 -	CR7E	4578	0,6			225	CR7EIX	7385
LT-F 400F	400	02 -	CR7E	4578	0,6			225	CR7EIX	7385
LT-F 400	400	02 -	CR7E	4578	0,6			225	CR7EIX	7385
LT-Z 400	400	02 -	CR7E	4578	0,6			225	CR7EIX	7385
LT-A 500F	500	00 -	CR6E	6965	0,6					
LT-F 500	500	98 - 99	CR7E	4578	0,6			225	CR7EIX	7385
LT-F 500F	500	00 -	CR6E	6965	0,6					

SYM

Track Runner 200	200	06 -	CR8E	1275	0,6			226	CR8EIX	4218
Quad Lander 250	250	06 -	CR8E	1275	0,6			226	CR8EIX	4218

					Order No.		Gold-Palladium		Order No.	Quick-No.	Iridium		Order No.
TNG													
Venice 492	50		BP7HS	5111	0,7	BP7HVX	7468				BPR7HIX	5944	
Del Ray 125	125		C7HSA	4629	0,7	C7HVX	4533				CR7HIX	7544	
Milano 125	125		C7HSA	4629	0,7	C7HVX	4533				CR7HIX	7544	
Baja 150	150		C7HSA	4629	0,6	C7HVX	4533				CR7HIX	7544	
Milano 150	150		C7HSA	4629	0,7	C7HVX	4533				CR7HIX	7544	
TRAILBLAZER													
50	50		BP7HS	5111	0,7	BP7HVX	7468				BPR7HIX	5944	
Mini	50		BPR7HS	6422	0,7	BPR7HVX	2938	215			BPR7HIX	5944	
2-Stroke/ Takt	90		BP7HS	5111	0,7	BP7HVX	7468				BPR7HIX	5944	
4-Stroke/ Takt	90		CR7HSA	4549	0,7						CR7HIX	7544	
170	170	04 -	DR8EA	7162	0,7	DR8EVX	6354				DR8EIX	6681	
Trailblazer 170	170		DR8EA	7162	0,7	DR8EVX	6354				DR8EIX	6681	
250	250		CR8HSA	2086	0,8	CR8HVX	7236				CR8HIX	7669	
TRAILSPORT													
TS-500 5.0hp		04 -	BR2LM	5798	0,6					310			
TSB-600 6.0hp		04 -	BR2LM	5798	0,6					310			
UNILLI													
KX 150	150	05 -	CR7E	4578	0,6					225	CR7EIX	7385	
UNISOM													
Desert-Cat 50	50	04 -	BR8HS	4322	0,6	BR8HVX	6265	212			BR8HIX	7001	
Desert-Cat 90	90	04 -	BR8HS	4322	0,6	BR8HVX	6265	212			BR8HIX	7001	
UNITED MOTORS													
Dirt Squirt	50		BR8HS	4322	0,6	BR8HVX	6265	212			BR8HIX	7001	
Monntrax	50		BPR7HS	6422	0,8	BPR7HVX	2938	215			BPR7HIX	5944	
Dirt Squirt	90		BR8HS	4322	0,6	BR8HVX	6265	212			BR8HIX	7001	
Earthlander	90		BPR7HS	6422	0,8	BPR7HVX	2938	215			BPR7HIX	5944	
Moontrax	90		BPR7HS	6422	0,6	BPR7HVX	2938	215			BPR7HIX	5944	
Reptile	90		C7HSA	4629	0,7	C7HVX	4533				CR7HIX	7544	
VENTO													
Avalanche EX100	100		BPR6HS	7022	0,7	BPR6HVX	2740	214			BPR6HIX	4085	
Rhino 250	250		DR8EA	7162	0,7	DR8EVX	6354				DR8EIX	6681	
VINSON													
ETV 4Takt	150		C7HSA	4629	0,6	C7HVX	4533				CR7HIX	7544	
ETV 4Takt	250		C7HSA	4629	0,6	C7HVX	4533				CR7HIX	7544	
XING FU													
XF Trail 150	150	05 -	C7HSA	4629	0,6	C7HVX	4533				CR7HIX	7544	
XF Trail 250	250	05 -	C7HSA	4629	0,6	C7HVX	4533				CR7HIX	7544	
YAMAHA													
YMF 50 S	50	04 -	CR7HS	7223	0,7						CR7HIX	7544	
YF 60 (1HN)	60	87 - 88	BPR6HS	7022	0,7	BPR6HVX	2740	214			BPR6HIX	4085	
YFM 80	80		CR7HS	7223	0,7						CR7HIX	7544	
YFM 80 W Badger	80	02 -	CR7HS	7223	0,7						CR7HIX	7544	
YFM 80 W	80	02 -	CR7HS	7223	0,7						CR7HIX	7544	



Order No.



Gold-Palladium



Order No.

Quick-No.

Iridium



Order No.

YAMAHA

YFM 80 E / F	80	93 -	C7HSA	4629	0,7	C7HVX	4533		CR7HIX	7544
YFA 1 Breeze	125	89 - 04	CR7HS	7223	0,7				CR7HIX	7544
YFA 1 F	125	94 -	C7HSA	4629	0,7	C7HVX	4533		CR7HIX	7544
YT 125	125		BP6ES	7811	0,8	BP6EVX	5832		BPR6EIX	6637
YT 125 CH	125		BP6ES	7811	0,8	BP6EVX	5832		BPR6EIX	6637
YT 125 H	125		BP6ES	7811	0,8	BP6EVX	5832		BPR6EIX	6637
YT 175	175		BP7ES	2412	0,8	BP7EVX	7270	206	BPR7EIX	4055
YFM 200	200	92 -	D7EA	7912	0,6	D7EVX	2734			
YFM 200 (52H)	200	85 - 86	DR7ES	3123	0,7					
YFM 225 (2HT)	200		DR7ES	3123	0,7					
YFM 225 (59V)	200		DR7ES	3123	0,7					
YFS 200 Blaster	200	90 - 04	BR8ES	5422	0,8	BR8EVX	1262	207	BR8EIX	5044
YFS 200 E / F	200	93 -	B8ES	2411	0,8	B8EVX	7051	201	BR8EIX	5044
TT 225	225		DR8ESL	2923	0,7	DR8EVX	6354	218	DR8EIX	6681
YFM 225 59V/2HT	225	92 -	DR7ES	3123	0,7					
YFB 250 / E / F / FWF	250	93 -	D7EA	7912	0,7	D7EVX	2734			
YFB 250 / FW	250	94 -	DR7EA	7839	0,7					
YFM 250 Timberwolf	250		DR7EA	7839	0,7					
YFM 250 (3GH)	250	90 -	DR7ES	3123	0,7					
YFM 250 Bruin	250	05 -	DR7EA	7839	0,6					
YFM 250 X Bear Tracker	250	99 - 04	DR7EA	7839	0,7					
YFM 350 (3HN)	350	89 -	DR8ESL	2923	0,6	DR8EVX	6354	218	DR8EIX	6681
YFM 350 2HR/2HN	350	92 -	DR8ESL	2923	0,6	DR8EVX	6354	218	DR8EIX	6681
YFM 350 4x4 (2HR)	350		DR8ESL	2923	0,7	DR8EVX	6354	218	DR8EIX	6681
YFM 350 4x4 (3HN)	350		DR8ESL	2923	0,7	DR8EVX	6354	218	DR8EIX	6681
YFM 350 ERF / FWF / XF	350	94 -	D8EA	2120	0,7	D8EVX	2850	216	DR8EIX	6681
YFM 350 FW	350	94 -	DR8EA	7162	0,7	DR8EVX	6354		DR8EIX	6681
YFM 350 X Warrior	350	97 - 04	DR8EA	7162	0,7	DR8EVX	6354		DR8EIX	6681
YZF 350	350	94 -	BR8ES	5422	0,8	BR8EVX	1262	207	BR8EIX	5044
YZF 350 Banshee	350	86 - 04	BR8ES	5422	0,8	BR8EVX	1262	207	BR8EIX	5044
YZF 350 E / F	350	93 -	B8ES	2411	0,8	B8EVX	7051	201	BR8EIX	5044
YFM 400	400	93 -	DR8ESL	2923	0,7	DR8EVX	6354	218	DR8EIX	6681
YFM 400 AN Kodiak	400	03 - 04	DR8EA	7162	0,7	DR8EVX	6354		DR8EIX	6681
YFM 400 FW	400	94 - 04	DR8EA	7162	0,7	DR8EVX	6354		DR8EIX	6681
YFM 400 FWF	400	94 -	D8EA	2120	0,7	D8EVX	2850	216	DR8EIX	6681
YFM 400 FWA Kodiak	400	00 - 04	DR8EA	7162	0,7	DR8EVX	6354		DR8EIX	6681
YFM 450 FWAN Kodiak	400	03 - 04	DR8EA	7162	0,7	DR8EVX	6354		DR8EIX	6681
YZF 450 S	450	04 -	CR8E	1275	0,7	CR8EVX	6487	226	CR8EIX	4218
YFM 660 FWA Grizzly	660	02 - 04	DPR8EA-9	4929	0,9	DPR8EVX-9	2872	221	DPR8EIX-9	2202
YFM 660 R	660	01 - 04	DPR8EA-9	4929	0,9	DPR8EVX-9	2872	221	DPR8EIX-9	2202
YXR 660 Rhino	660	05 -	DPR8EA-9	4929	0,9	DPR8EVX-9	2872	221	DPR8EIX-9	2202
YXR 660 FAS	660	04 -	DPR8EA-9	4929	0,9	DPR8EVX-9	2872	221	DPR8EIX-9	2202
YFM 700 Grizzly	700	09.06 -	CR7E	4578	0,6			225	CR7EIX	7385
YFM 700	700	05 -	CR7E	4578	0,6			225	CR7EIX	7385

YERF-DOG

23000	90	04 -	BP7HS	5111	0,7	BP7HVX	7468		BPR7HIX	5944
23100	150	04 -	BR6ES	4922	0,6					

ZONGSHEN

ZS 125 ST	125	04 -	BKR5E	7938	0,6				BKR5EIX	6341
-----------	-----	------	-------	------	-----	--	--	--	---------	------

Order-
No.**APRILIA**

AF1 50		01.86-	50	LB05F	8051
ET 50 AE,-Fire		01.87-	50	LB05F	8051
GL 50		02.93-	50	LB05F	8051
LX 50		02.93-	50	LB05F	8051
RC 50		01.79-12.82	50	LB05F	8051
Red Rose 50		06.87-	50	LB05F	8051
RS 50 Extrema/Replica		01.93-	50	LB05F	8051
RX 50		09.90-	50	LB05F	8051
Tuareg 50		01.87-	50	LB05F	8051
RX 125		01.90-	125	LB05F	8051

BMW

R 45	26kW	06.78-06.83	475	LB05F	8051
R 45	20kW	06.78-07.85	475	LB05F	8051
R 50/5			500	LB05F	8051
R 60/5, /6, /7		-06.78	600	LB05F	8051
R 65		06.78-	650	LB05F	8051
R 75/5, /6, /7			750	LB05F	8051
R 80		08.82-	95 800	LB05F	8051
R 80 R		80-	800	LB05F	8051
R 80 GS		08.82-	94 800	LB05F	8051
R 80 RT		08.82-	95 800	LB05F	8051
R 80 ST		08.82-	95 800	LB05F	8051
R 80/7N /7S		09.77-08.80	800	LB05F	8051
R 850 GS		98-	850	LB05F	8051
R 850 R	52kW	10.94-	850	LB05F	8051
R 850 RT		99-	850	LB05F	8051
R 90/6			900	LB05F	8051
R 90/S			900	LB05F	8051
R 100			1000	LB05F	8051
R 100 R		94-	1000	LB05F	8051
R 100 RS		09.86-	1000	LB05F	8051
R 100/7			1000	LB05F	8051
R 100/CS /RT			1000	LB05F	8051
R 100/RS		-08.86	1000	LB05F	8051
R 100 GS		09.86-	1000	LB05F	8051
R 100/S /T		09.76-08.80	1000	LB05F	8051

CAGIVA

WMX 125/84			125	LB05F	8051
WMX 125/85			125	LB05F	8051
WMX 125/88			125	LB05F	8051
All			175	LB05F	8051
All			200	LB05F	8051
MX,MXR,RR,RX,WMX			250	LB05F	8051
NC,RL,SS,SST		01.83-	250	LB05F	8051
RX 250 Rally		01.79-11.83	250	LB05F	8051
SX, SXT		01.83-12.84	250	LB05F	8051
Ala Blu 350			350	LB05F	8051
Ala Rossa 350/4T		01.83-	350	LB05F	8051
Ala Verde 350			350	LB05F	8051
Alazzurra 350 (D)		01.84-	350	LB05F	8051

Order-
No.**CAGIVA**

Elefant 350 (D)		350	LB05F	8051
Lucky 350		350	LB05F	8051
SST 350		350	LB05F	8051
W12	94-	350	SD05FP	8325
W16	94-	600	SB05F	8080

DAELIM

125 Daystar	01.00-	125	XB01F	8431
VC 125 Advance	95-	125	XB01F	8431
VT 125 Evolution	03.98-	125	XB01F	8431

DUCATI

600 Pantah SL/TL (D)	81-	600	VB05F	8032
900 S,SS,GTS,SD,S2,HR (D)	80-	900	VB05F	8032

GAS GAS

TT 125		125	LB05F/CR2	8051/8048
TT 200		200	LB05F/CR2	8051/8048
Cross 250		250	LB05F/CR2	8051/8048
TT 250		250	LB05F/CR2	8051/8048
TT 300		300	LB05F/CR2	8051/8048

GILERA

50 TS	01.79- 12.82	50	LB05F	8051
CB1 4V		50	LB05F	8051
Touring	01.73- 12.81	50	LB05F	8051
Trial		50	LB05F	8051
Giubileo 4 T, SS		98	LB05F	8051
125 5V Regolarità		125	LB05F	8051
125 Arcore, Export	01.72- 06.80	125	LB05F	8051
125 SV Regolarità		125	LB05F	8051
Saturno 500	04.88- 92	500	LB05F	8051

HERCULES

City Bike C1	10.72- 08.78	50	LB05F	8051
City Bike C2	10.72- 08.78	50	LB05F	8051
City Bike C3	09.74- 08.78	50	LB05F	8051
Hobby Rider HR 1	10.72- 12.87	50	LB05F	8051
Hobby Rider HR 2	10.72- 12.87	50	LB05F	8051
Jogging		50	LB05F	8051
K 50	- 08.78	50	LB05F	8051
K 50 Ultra	- 08.78	50	LB05F	8051
K 50 Ultra II	- 08.78	50	LB05F	8051
K 50 Ultra LC	- 08.78	50	LB05F	8051
K 50 Ultra LC II	- 08.78	50	LB05F	8051
K 50 Ultra LC III	- 08.78	50	LB05F	8051
KX 5	01.86-	50	LB05F	8051
Lastboy		50	LB05F	8051
M1	10.72- 12.77	50	LB05F	8051
M2	10.72- 12.77	50	LB05F	8051
M4	09.74- 12.78	50	LB05F	8051
M5	09.74- 12.78	50	LB05F	8051

Order-
No.**HERCULES**

MK 1S	01.78-08.80	50	LB05F	8051
MK 2S	01.78-08.80	50	LB05F	8051
MP 2	10.72-12.77	50	LB05F	8051
MP 4	10.72-12.77	50	LB05F	8051
MX 1	01.89-	50	LB05F	8051
MX 1		50	LB05F	8051
Optima 3	01.78-	50	LB05F	8051
Optima 50		50	LB05F	8051
Prima 2		50	LB05F	8051
Prima 2S	01.89-	50	LB05F	8051
Prima 3		50	LB05F	8051
Prima 3S	01.89-	50	LB05F	8051
Prima 4		50	LB05F	8051
Prima 4LN,5LN		50	LB05F	8051
Prima 5		50	LB05F	8051
Prima 5,5S,5SE	01.89-	50	LB05F	8051
Prima 6		50	LB05F	8051
Prima G3		50	LB05F	8051
Prima GT	01.89-	50	LB05F	8051
Prima GT,GX		50	LB05F	8051
Prima Presto		50	LB05F	8051
Prima Pronto		50	LB05F	8051
Prima S		50	LB05F	8051
Prima SL		50	LB05F	8051
Prima SX		50	LB05F	8051
Sport Bike SB1	10.72-08.74	50	LB05F	8051
Sport Bike SB2	10.72-08.79	50	LB05F	8051
Sport Bike SB3	09.74-08.79	50	LB05F	8051
Sport Bike SB5	09.74-08.76	50	LB05F	8051
Supra 2D,3D	06.80-	50	LB05F	8051
Supra 4	06.78-	50	LB05F	8051
Supra 4GP	01.80-	50	LB05F	8051
Supra Enduro	03.80-	50	LB05F	8051
Ultra 50		50	LB05F	8051
XE 5	01.86-	50	LB05F	8051
ZX 1		50	LB05F	8051
RX 9		80	LB05F	8051
Ultra 80 LC		80	LB05F	8051
Ultra 80 AC	01.82-	80	LB05F	8051
XE 9	01.82-	80	LB05F	8051
K 100 X		100	LB05F	8051
K 125 BW Military	09.74-	125	LB05F	8051
K 125 GS		125	LB05F	8051
K 125 MC		125	LB05F	8051
K 125 S	10.72-08.79	125	LB05F	8051
K 125 T	10.72-08.79	125	LB05F	8051
K 125 X		125	LB05F	8051
175 GS		175	LB05F	8051
250 GS		250	LB05F	8051
350 GS		350	LB05F	8051

Order-
No.**HONDA**

Camino PA 50		01.75- 12.87	50	LB05F	8051
CB 50			50	LD05F	8060
CB 50 Y		01.73- 01.83	50	LD05F	8060
CY 50		01.81-	50	LD05F	8060
Elite 50/S			50	LB05F	8051
MB 50 F	(AC01)		50	LB05F	8051
MB 50 S	(AC01)		50	LB05F	8051
MBX 50 M	(AC05)		50	LB05EMH	8160
MBX 50 S	(AC05)		50	LB05EMH	8160
MBX 50 SD	(AC05)		50	LB05EMH	8160
MR 50			50	LB05F	8051
MT 50 F	(AD04)		50	LB05F	8051
MT 50 S	(AD04)		50	LB05F	8051
MTX 50 R			50	LB05EMH	8160
MTX 50 S		86-	50	LB05EMH	8160
NC 50			50	LB05F	8051
NE 50			50	LB05F	8051
NE 50 Vision		90-	50	LB05F	8051
NSR 50		89-	50	LB05F	8051
NT 50			50	LB05F	8051
NX 50			50	LB05F	8051
NX 50 M			50	LB05F	8051
PA 50		84-	50	LB05F	8051
PF 50			50	LB05F	8051
PK 50 DX	(AB25)	95-	50	LB05F	8051
PK 50 Wallaroo		90-	50	LB05F	8051
PM 50			50	LB05F	8051
PX 50		84-	50	LB05F	8051
PX 50 E		80-	50	LB05F	8051
PX 50 R		85-	50	LB05F	8051
PZ 50			50	LB05F	8051
SA 50	(AF29)		50	LB05F	8051
SE 50			50	LB05F	8051
SFX 50		96-	50	LB05F	8051
SH 50 T	(AF40)	97-	50	LB05F	8051
SH 50		01.84-	50	LB05F	8051
SJ 50 Bali			50	LB05F	8051
ST 50 C	(AB23) Dax		50	LD05F	8060
TLM 50			50	LB05EMH	8160
XL 50		01.80-	50	LD05F	8060
XR 50		93- 02	50	LD05F	8060
Z 50 GZ	(Monkey)	01.80- 12.84	50	LD05F	8060
Z 50 J	(Monkey)		50	LD05F	8060
Z 50 R	(Monkey)	94-	50	LD05F	8060
ZB 50 P	(AB22)(Monkey)	88-	50	VD05F	8052
CT 70		92-	70	LD05F	8060
ST 70		94-	70	LD05F	8060
NS-1		96-	75	LB05F	8051
CR 80 R		86-	80	LB05EMH	8160
CR 80 R		- 85	80	LB05EMH	8160
CY 80			80	LD05F	8060
MB 80	(HC01)	01.80-	80	LB05F	8051

Order-
No.**HONDA**

MBX 80 SWD/SW2D (HC04)	87-	80	LB05F	8051
MCX 80 (HC05)	01.80-	80	LB05F	8051
MT 80 F		80	LB05F	8051
MT 80 S (HD02)		80	LB05F	8051
MTX 80 C	82-	80	LB05EMH	8160
MTX 80 R (D) (HD08)		80	LB05EMH	8160
MTX 80 R (F) (HD08)		80	LB05EMH	8160
MTX 80 R II (HD09)	87-	80	LB05EMH	8160
MTX 80 RS (HD08)	83- 85	80	LB05EMH	8160
NSR 80		80	LB05F	8051
SH 80 E Scoopy	84-	80	LB05F	8051
XR 80R	92-	80	LB05F	8051
EZ 90	93-	90	LB05F	8051
NH 90 M	93-	90	LB05F	8051
NH 90 Yupy	90-	90	LB05F	8051
XR 100R	92-	100	VD05F	8052
CG 110		110	LD05F	8060
CA 125 Rebel (JC24)	95-	125	LD05F	8060
CA 125 C Rebel (JC26)	97-	125	LD05F	8060
CB 125		125	LD05F	8060
CB 125 K		125	LD05F	8060
CB 125 T		125	LD05F	8060
CB 125 Y		125	LD05F	8060
CG 125		125	LD05F	8060
CG 125 (JC27)	98-	125	LD05FP	8070
CH 125		125	LD05F	8060
CLR 125 Cityfly (JD18A/B)	98-	125	VD05FMH	8425
CM 125 (JC05)		125	LD05FP	8070
CM 125 C Custum	94-	125	LD05F	8060
CR 125 R		125	LB05F/CR2	8051/8048
Italia 125 (I)		125	LD05F	8060
Lead 125 (JF01)		125	LB05F/CR2	8051/8048
MBX 125 F		125	SD05FM	8392
MTX 125		125	LB05EMH	8160
MTX 125 R (I)		125	LB05F	8051
MTX 125 R2 (I)		125	LB05F	8051
NS 125 F (I)		125	LB05EMH	8160
NS 125 R (I)		125	LB05F	8051
NSR 125 F		125	LB05F	8051
TL 125		125	VD05F	8052
XL 125 (I)		125	LD05F	8060
XL 125 R		125	VD05FMH	8425
XL 125 S		125	LD05F	8060
XLR 125 R	98-	125	VD05FMH	8425
XR 125		125	LD05F	8060
CD 185 T		185	LD05F	8060
CM 185 T	01.78-	185	LD05F	8060
XL 185 S	01.79-	185	VD05F	8052
CD 200 T		200	LD05F	8060
CM 200 T		200	LD05F	8060
MTX 200 RW (MD07)	83- 85	200	LB05EMH	8160
XL 200 R	01.83-	200	VD05F	8052



Order-
No.

HONDA

250 Spacy (I)			250	LD05F/CR2	8060/8048
CB 250 (MC26)		96-	250	XD05F	8072
CB 250 N		01.80-	250	XD05F	8072
CB 250 RS (MC02)		01.80-	250	XD05F	8072
CB 250 T			250	LD05F	8060
CBX 250			250	SD05FM	8392
CD 250 U			250	XD05F	8072
CH 250			250	VD05F	8052
CM 250 C (MC06)		01.82-	250	LD05FP	8070
CMX 250 C (MC32B)		97-	250	VD05F	8052
CMX 250 CT (MC13)		96-	250	VD05F	8052
CR 250 R		82- 02	250	LB05F/CR2	8051/8048
CR 250 R		- 81	250	LB05F/CR2	8051/8048
NX 250 J (MD21)		88-	250	VD05F	8052
NX 250 K (MD21)		89-	250	VD05F	8052
NX 250 L (MD25)		91-	250	VD05F	8052
TLR 250			250	VD05FMH	8425
VT 250 F2			250	SD05FMC	30465
XL 250 R (MD11)		86-	250	SD05F/CR1	8022/8035
XL 250 R (MD11)		84- 85	250	SD05F/CR1	8022/8035
XL 250 R (MD11)		- 83	250	SD05F/CR1	8022/8035
XR 250 L		92-	250	SD05F	8022
XL 350 R (ND03)		85- 87	350	VD05F	8052
XR 350 R			350	VD05F	8052
CB 400 A		01.79-	400	VD05F(IN)XD05F(OUT)	8052/8072
CB 400 N		01.78-12.84	400	XD05F	8072
CB 400 T			400	YB05F	8082
CB-1 (NC27)		91-	400	SD05F/CR1	8022/8035
CBX 400 F			400	SD05FMC	30465
CBX 400 F2			400	SD05FMC	30465
CM 400 T		01.80-12.84	400	XD05F	8072
CB 450 N (PC14)		85-	450	LB05F	8051
CB 450 S (PC17)(D)		86- 88	450	XD05F	8072
CB 450 S (PC17)(I)			450	XD05F	8072
CMX 450 C			450	XD05F	8072
FT 500 (PC07)		01.82-12.85	500	VD05F	8052
GB 500 (PC16)		92-	500	SD05F	8022
VF 500 F (PC12)		84-	500	SD05FMC/CR1	30465/8035
VF 500 F2 (PC12)		- 84	500	SD05FMC/CR1	30465/8035
VF 500 F2 (PC12)		85-	500	SD05FMC/CR1	30465/8035
VT 500 C (PC08)		83-	500	VD05F	8052
VT 500 E (PC11)		83- 85	500	VD05F	8052
XL 500 R (PD02)		86-	500	VD05F	8052
XL 500 R (PD02)		- 85	500	VD05F	8052
XL 500 S (PD01)		01.79-12.81	500	VD05F	8052
XR 500			500	VD05F	8052
XR 500 R			500	VD05F	8052
CB 550		06.71-12.87	550	SD05F(IN)XD05F(OUT)	8022/8072
CB 550 (F1/F2)		76-	550	SD05F(IN)XD05F(OUT)	8022/8072
CB 550 (K3/4)		76-	550	SD05F(IN)XD05F(OUT)	8022/8072
CB 550 F		06.71-12.87	550	SD05FMC	30465
CBX 550 F (PC04)			550	SD05FMC	30465

Order-
No.**HONDA**

CBX 550 F2	(PC04)		550	SD05FMC	30465
CBR 600 F	(PC25)	91- 94	600	CR1	8035
CBR 600 F	(PC19)	87- 88	600	CR1	8035
CBR 600 F	(PC23)	89- 90	600	CR1	8035
CBR 600 F2		93- 94	600	CR1	8035
CBR 600 F3	(PC31)(PC35)	95- 00	600	CR1	8035
CBX 600 E		01.83- 12.87	600	SD05FMC	30465
NTV 600			600	SD05F/VD05F	8022/8052
XL 600 L			600	SD05FM	8392
XL 600 LM	(PD04)	85- 87	600	SD05FM	8392
XL 600 R	(PD03)	83- 87	600	SD05FM	8392
XL 600 RM (I)			600	SD05FM	8392
XL 600 RM	(PD04)	86-	600	SD05FM	8392
XL 600 V / VN		87-	600	SD05F	8022
XR 600 / V			600	SD05FM	8392
XR 600 R / L		01.87-	600	SD05FM	8392
CB 650 C	(RC05)		650	XD05F	8072
CB 650 SC	(RC08)	01.80-	650	XD05F	8072
CB 650 Z			650	XD05F	8072
CBX 650 E	(RC13)	83-	650	SD05FMC	30465
FMX 650		05-	650	SD05F	8022
NX 650	(RD02)/Dominator	88-	650	SD05F	8022
NX 650 Dominator	(RD08)(I)	01.88-	650	SD05F	8022
Transalp XL 650		94-	650	SD05F	8022
XL 650L		94-	650	SD05F	8022
CB 750	(RC42)	92-	750	SD05F	8022
CB 750	(RC04)	01.82- 12.83	750	SD05F	8022
CB 750 C	(RC06)	01.80-	750	SD05F	8022
CB 750 F		- 91	750	SD05F	8022
CB 750 F2			750	SD05F	8022
CB 750 F2N / FII		91-	750	SD05F(IN)XD05F(OUT)	8022/8072
CB 750 FA (I)			750	SD05F	8022
CB 750 Four (I)			750	SD05F	8022
CB 750 FZ			750	SD05F	8022
CB 750 K		01.82- 12.83	750	SD05F	8022
CB 750 KZ			750	SD05F	8022
NR 750	(RC40)	93-	750	SD05F	8022
RVF	(RC45)	94-	750	SD05F	8022
VF 750 C		95- 00	750	SD05F/CR1	8022/8035
VF 750 C Magna		94- 95	750	CR1	8035
VF 750 F	(RC15)	83- 84	750	CR1	8035
VF 750 S	(RC07)	82- 83	750	SD05F	8022
VFR 750 F		94-	750	XD05F	8072
VFR 750 F (I)			750	XD05F	8072
VFR 750 F	(RC24)	88- 89	750	XD05F	8072
VFR 750 F	(RC24)	86- 87	750	XD05F	8072
VFR 750 F	(RC36)	90- 94	750	XD05F	8072
VFR 750 FJ (I)			750	XD05F	8072
VT 750 C	(RC29)	87-	750	XD05F/VD05F	8072/8052
VT 750 C/C2V	(RC44)	97-	750	XD05F/VD05F	8072/8052
PC 800 Pacific Coast		98-	800	SD05F	8022
CB 900 F		01.79-	900	SD05F(IN)XD05F(OUT)	8022/8072

Order-
No.**HONDA**

CB 900 F2		01.79-12.83	900	SD05F(IN)XD05F(OUT)	8022/8072
CBR 900 RR (SC33)		96-	900	XD05F	8072
CBR 900 RR (SC28)		91-	900	XD05F	8072
CB 1000 F (SC30)		93- 00	1000	SD05F(IN)XD05F(OUT)	8022/8072
CBR 1000 F (SC24)		95- 00	1000	SD05F(IN)XD05F(OUT)	8022/8072
CBR 1000 F (SC21)		87- 88	1000	SD05F(IN)XD05F(OUT)	8022/8072
CBR 1000 F (SC24)		89- 92	1000	SD05F(IN)XD05F(OUT)	8022/8072
GL 1000 (GL1)			1000	XD05F	8072
VF 1000 F		- 86	1000	SD05FMC	30465
VF 1000 F (SC15)		87-	1000	SD05FMC	30465
VF 1000 F2 (SC15)		85-	1000	SD05FMC	30465
VF 1000 R (SC16)		84- 86	1000	SD05FMC	30465
CBX 1000 (CB1)			1050	XD05F	8072
CB 1100 F (SC11)			1100	XD05F	8072
CB 1100 R (SC08)			1100	SD05F(IN)XD05F(OUT)	8022/8072
GL 1100 (SC02)		- 81	1100	XD05F	8072
GL 1100 (SC02)		82-	1100	XD05F	8072
GL 1100 DX (SC02)		- 81	1100	XD05F	8072
GL 1100 DX (SC02)		82-	1100	XD05F	8072
GL 1100 R			1100	XD05F	8072
VF 1100 C (SC12)		83-	1100	SD05FMC/CR1	30465/8035
GL 1200 (SC14)		84- 87	1200	XD05F	8072

HUSQVARNA

CR 250		01-	250	LB05F/CR2	8051/8048
WR 250		01-	250	LB05F/CR2	8051/8048
410 TE (2AA)		96- 00	400	SD05FP	8325
TE 410		01-	400	SD05FP	8325
SM 570 R		01-	570	SD05FP	8325
TC 570		07.01-	576	SD05FP	8325
TE 570		07.01-	576	SD05FP	8325
610 e TE/TC		98-	610	SD05FP	8325
SM 610 e		98-	610	SD05FP	8325

KAWASAKI

AE 50		83-	50	LB05F	8051
AE 50		- 82	50	LB05F	8051
AR 50		93-	50	LB05F	8051
AR 50		- 82	50	LB05F	8051
AR 50		83- 92	50	LB05F	8051
AV 50		84-	50	LB05F	8051
AV 50		- 83	50	LB05F	8051
KH 50			50	LB05F	8051
KMX 50 (KSR-I)		93-	50	LB05F	8051
KX 60		- 92	60	LB05F	8051
KX 60		93-	60	LB05F	8051
AE 80		- 82	80	LB05F	8051
AE 80		83-	80	LB05F	8051
AN 80			80	LB05F	8051
AR 80		83-	80	LB05F	8051
AR 80		- 82	80	LB05F	8051
DX 80			80	LB05F	8051

Order-
No.**KAWASAKI**

KD 80		80	LB05F	8051
KDX 80		80	LB05F	8051
KH 80		80	LB05F	8051
KMX 80 (KSR-2)	93-	80	LB05F	8051
KX 80	- 80	80	LBER	8308
KX 80	81- 82	80	LBER	8308
KX 80	83- 91	80	LBER	8308
KX 80 (KX80S7)	97-	80	LBER	8308
KX 80 (KX80V7)	97-	80	LBER	8308
KX 80 /80-2	92-	80	LBER	8308
KC 90		90	LB05F	8051
KC 90 A		90	LB05F	8051
KC 90 C		90	LB05F	8051
KC 90 D		90	LB05F	8051
KE 90		90	LB05F	8051
KH 90		90	LB05F	8051
KM 90		90	LB05F	8051
KC 100	80-	100	LB05F	8051
KD 100		100	LB05E	8031
KE 100	01.76- 12.79	100	LB05F	8051
KE 100	93-	100	LB05F	8051
KH 100		100	LB05F	8051
KM 100	01.79- 12.81	100	LB05E	8031
KV 100		100	LB05E	8031
AR 125	01.82-	125	LB05F	8051
DX 125		125	LB05F	8051
KC 125		125	LB05F	8051
KD 125		125	LB05E	8031
KDX 125 SR		125	LB05F/CR2	8051/8048
KE 125	01.76- 12.83	125	LB05E	8031
KH 125	01.77- 12.81	125	LB05F	8051
KH 125	93-	125	LB05F	8051
KMX 125	01.86-	125	LB05F	8051
KS 125	01.73- 12.76	125	LB05E	8031
KX 125	85- 90	125	LB05F	8051
KX 125	90- 91	125	LB05EMH	8160
KX 125	91- 99	125	LB05EMH	8160
KX 125	82- 84	125	LB05F	8051
KX 125 (KX125K4)	97-	125	LB05EMH	8160
KD 175		175	LB05F	8051
KDX 175	01.80- 12.84	175	LBER	8308
KE 175	- 80	175	LB05F	8051
KE 175	81-	175	LB05F	8051
KE 175 B		175	LB05F	8051
KE 175 D		175	LB05F	8051
KDX 200	93- 94	200	LBER	8308
KDX 200 H	95-	200	LB05EMH	8160
KMX 200	01.88- 92	200	LB05F/CR2	8051/8048
Z 200	01.77- 12.79	200	LB05F	8051
BJ 250A (Estrella)	93- 96	250	LD05F	8060
BJ 250 C(Estrella)	97-	250	LD05F	8060
GPZ 250 Belt Drive		250	LD05F	8060

Order-
No.**KAWASAKI**

GPZ 250 R		250	LD05F	8060
KE 250		250	LB05E	8031
KH 250	01.73- 12.79	250	LB05E	8031
KL 250 (A)	01.79- 12.83	250	LB05F	8051
KL 250 (KLR 250)	01.83- 91	250	LD05F	8060
KLX 250	01.80- 12.84	250	LB05E	8031
KLX 250 (KLX250E)	93-	250	XD05F	8072
KR-1R		250	LB05F	8051
KR-1S		250	LB05F	8051
KT 250		250	LB05E	8031
KX 250	- 91	250	LB05F	8051
LTD 250 Belt Drive		250	LD05F	8060
LX 250		250	LB05F	8051
Z 250		250	LB05F	8051
Z 250 A	01.80-	250	LD05F	8060
Z 250 B		250	LD05F	8060
Z 250 Belt Drive		250	LD05F	8060
Z 250 C	01.80-	250	LB05F	8051
Z 250 D		250	LB05F	8051
Z 250 G		250	LB05F	8051
Z 250 J		250	LD05F	8060
Z 250 LTD	01.81-	250	LB05F	8051
Z 250 T		250	LD05F	8060
ZR 250 (Balius)	93-	250	SD05F/CR1	8022/8035
MULE 500/ KAF 300 A&B (UV)	92- 96	300	LB05F	8051
GPZ 305 Belt Drive	01.83-	305	LD05F	8060
Z 305		305	LD05F	8060
EN 400 A		400	XD05F	8072
GPZ 400		400	XD05F	8072
GPZ 400 F		400	XD05F	8072
GPZ 400 F II		400	XD05F	8072
KH 400		400	LB05E	8031
KLE 400	93-	400	XD05F	8072
KX 400		400	LB05E	8308
LTD 400		400	LD05F	8060
Z 400	01.76- 12.81	400	LB05F	8051
Z 400 A/B/C/D/G/H		400	LB05F	8051
Z 400 F		400	LD05F	8060
Z 400 F	83-	400	LD05F	8060
Z 400 F-II		400	LD05F	8060
Z 400 J		400	LD05F	8060
Z 400 J (I)		400	LD05F	8060
Z 400 K		400	LD05F	8060
Z 400 LTD		400	LB05F	8051
Z 400 M		400	LD05F	8060
ZL 400 (Eliminator 400SE)	93-	400	LD05F	8060
ZR 400	- 83	400	LD05F	8060
ZR 400	84-	400	LD05F	8060
ZR 400-C (Zephyr 400)	93-	400	LD05F/CR2	8060/8048
ZR 400-D (Xanthus)	93-	400	LD05F	8060
ZX 400 (Z 400-F2)	93-	400	LD05F	8060
Z 440	01.80- 12.85	440	LB05F	8051

Order-
No.**KAWASAKI**

Z 440 H (I)		440	LB05F	8051
EN 450 A (I)		450	XD05F	8072
LTD 450	01.85-	450	LD05F	8060
EN 500	90-	500	XD05F	8072
EX 500 (GPZ 500S EN 500)	93-	500	XB05F	8062
KH 500		500	LB05E	8031
KX 500	93-	500	LB05E	8308
Z 500		500	LD05F	8060
ZR 500		500	LD05F	8060
GPZ 550		550	LD05F	8060
GPZ 550 Unitrack (I)		550	LD05F	8060
LTD 550	01.80- 12.85	550	LD05F	8060
Z 550		550	LD05F	8060
ZR 550 B Zephyr	91-	550	LD05F	8060
ZX 550 A1		550	LD05F	8060
ZL 600	01.86-	600	XD05F	8072
ZL 600 (ZL600B/B1)	95-	600	XD05F	8072
ZX 600 A (I)		600	LD05F	8060
ZX-6R Ninja (ZX600F1/F3)	95-	600	XD05F	8072
ZX-6R Ninja (ZX 600 H Kat)	98-	600	XD05F	8072
ZX-6R Ninja (ZX 600 G)	98-	600	XD05F	8072
KLR 650	09.86- 94	650	XD05F	8072
KLR 650 (KL650C1/C3)	95-	650	XD05F	8072
KLX 650 (KLX650C)	93-	650	SD05FM	8392
KLX 650 R	98-	650	SD05FM	8392
KLX 650 R (KLX650A)	93- 96	650	SD05FM	8392
Z 650		650	LB05F	8051
Z 650 F-B		650	LB05F	8051
LTD 700		700	LB05F	8051
750 Turbo	01.73- 12.86	750	LB05F	8051
GPX 750 R	01.87-	750	SD05F/CR1	8022/8035
GPX 750 R (I)		750	SD05F/CR1	8022/8035
GPZ 750	01.82-	750	LB05F	8051
GPZ 750 R	01.85-	750	SD05F/CR1	8022/8035
LTD 750 4 Cyl.	01.82- 12.87	750	LB05F	8051
VN 750 Twin		750	XD05F(IN)LD05F(OUT)	8072/8060
VN 750 Vulcan		750	XD05F(IN)LD05F(OUT)	8072/8060
Z 2		750	XD05F(IN)LD05F(OUT)	8072/8060
Z 750		750	LB05F	8051
ZR 750 C Zephyr	91- 00	750	LD05FP	8070
ZR 750 D1/2 Zephyr	96- 00	750	LD05FP	8070
ZX 750 J		750	LB05FP	8030
ZX 750 N1 Ninja ZX-7RR	96-	750	LB05FP	8030
ZX 750 P1/P2 Ninja ZX-7R	96-	750	LB05FP	8030
ZXR 750	09.88-	750	XD05F	8072
ZXR 750 R	90-	750	XD05F	8072
ZXR 750 R (ZX750L/M)	93-	750	XD05F	8072
GPZ 900 R		900	XD05F(IN)LD05F(OUT)	8072/8060
GPZ 900 R (I)		900	XD05F(IN)LD05F(OUT)	8072/8060
Z 1		900	SB05F(IN)YB05F(OUT)	8080/8082
Z 900	01.73- 12.76	900	SB05F(IN)YB05F(OUT)	8080/8082
KZ 1000 Police	93-	1000	XB05F(IN)LB05FP(OUT)	8062/8030

Order-
No.**KAWASAKI**

Z 1000	81-	1000	LB05F	8051
Z 1000	- 80	1000	LB05F	8051
Z 1000 ES (I)		1000	LB05F	8051
Z 1000 J (I)		1000	LB05F	8051
ZL 1000	09.86-	1000	SD05FM	8392
ZX 10	87- 90	1000	SD05FM	8392
GPZ 1100		1100	XB05F(IN)YB05F(OUT)	8062/8082
GPZ 1100 (ZX1100E1E1H)	95-	1100	XB05F(IN)YB05F(OUT)	8062/8082
GPZ 1100 ABS (ZX1100F1)	97-	1100	XB05F(IN)YB05F(OUT)	8062/8082
Z 1100		1100	XB05F(IN)YB05F(OUT)	8062/8082
Zephyr 1100 (ZR1100A)		1100	SD05FM	8392
ZRX 1100 (ZR1100C1)(ZRT10C)	97- 00	1100	SD05FM	8392
Zephyr (ZR 1100 B1)	96-	1100	SD05FM	8392
VN-15 A/B (VN-1500/SE/C/D2)		1500	XD05F(IN)LD05FP(OUT)	8072/8070

KTM

50 GP	10.81-	50	LB05F	8051
50 GXE		50	LB05F	8051
50 SX Pro Junior LC Beta Engine	03-	50	LB05EMH	8160
50 ME	10.81-	50	LB05F	8051
50 MLS		50	LB05F	8051
50 MMS		50	LB05F	8051
50 MS	10.81-	50	LB05F	8051
50 RSL		50	LB05F	8051
50 SX Pro Senior LC	03-	50	LB05EMH	8160
50 Senior	03-	50	LB05EMH	8160
Bora 25	10.81-	50	LB05F	8051
Bora 50		50	LB05F	8051
Comet	09.76-	50	LB05F	8051
Crazy (CH)		50	LB05F	8051
Foxi		50	LB05F	8051
Foxi (DK)		50	LB05F	8051
Hobby	10.81-	50	LB05F	8051
Pony	10.81-	50	LB05F	8051
Pony (CH)	10.81-	50	LB05F	8051
Postmofa		50	LB05F	8051
SM 25		50	LB05F	8051
Squadra		50	LB05F	8051
60 SX	98-	60	LB05EMH	8338
65 SX	98- 00	65	LB05EMH	8338
65 SX Beta Engine	03-	65	LB05EMH	8160
80 Chopper		80	LB05F	8051
80 Enduro		80	LB05F	8051
80 PL	06.83-12.84	80	LB05F	8051
80 RL	10.81-	80	LB05F	8051
80 RLS	10.81-	80	LB05F	8051
80 RLW	10.81-	80	LB05F	8051
80 RS	10.81-	80	LB05F	8051
Bora 80	10.81-	80	LB05F	8051
85 SX	04-	85	TB05EMA	8636
GS 100	08.73-08.76	100	LB05F	8051
MC 100	08.73-08.76	100	LB05F	8051

Order-
No.**KTM**

105 SX	04-	105	TB05EMA	8636
125 EGS	99-	125	LB05EMH	8160
125 EGS	98-	125	LB05EMH	8160
125 Enduro		125	LB05F	8051
125 EXC	99- 00	125	LB05EMH	8160
125 EXC	93- 95	125	LB05EMH	8160
125 EXC	08.97- 98	125	LB05EMH	8160
125 EXC	01-	125	LB05EMH	8160
125 EXC	96-08.97	125	LB05EMH	8160
125 EXC	98- 99	125	LB05EMH	8160
125 EXE	99-	125	LB05EMH	8160
125 LC 2 (Langgewinde)	96- 00	125	LB05EMH	8160
125 Sting	98-	125	LB05EMH	8160
125 Supermoto	99-	125	LB05EMH	8160
125 SX	99- 00	125	LB05EMH	8160
125 SX	96-08.97	125	LB05EMH	8160
125 SX (98er)	08.97- 98	125	LB05EMH	8160
125 SX	02-	125	LB05EMH	8160
GS 125 12,7 mm		125	LB05F	8051
MC 125 12,7 mm		125	LB05F	8051
MC 125 19,0 mm		125	LB05F	8051
MC 125 GP		125	LB05F	8051
GS 175		175	LB05F	8051
MC 175		175	LB05F	8051
200 EGS	99-	200	LB05EMH	8160
200 EGS	98-	200	LB05EMH	8160
200 EXC	98- 99	200	LB05EMH	8160
200 EXC	02-	200	LB05EMH	8160
200 EXC	99- 01	200	LB05EMH	8160
200 MXC	99-	200	LB05EMH	8160
200 SX	03-	200	LB05EMH	8160
250 DXC		250	LB05EMH	8160
250 EGS	98-	250	LB05EMH	8160
250 EGS	97-	250	LB05EMH	8160
250 EGS	99-	250	LB05EMH	8160
250 EGS	93- 95	250	LB05EMH	8160
250 Enduro		250	LB05EMH	8160
250 EXC Racing	03-	250	VD05EG	
250 EXC / Sixt Days	98- 01	250	LB05EMH	8160
250 EXC	97- 98	250	LB05EMH	8160
250 EXC Racing GS	03-	250	VD05EG	
250 EXC	96- 96	250	LB05EMH	8160
250 EXC Enduro Competition	03-	250	LB05EMH	8160
250 EXC	93- 95	250	LB05EMH	8160
250 MX		250	LB05EMH	8160
250 SX 4Takt	05-	250	VD05EG	
250 SX	93- 95	250	LB05EMH	8160
250 SX	97- 98	250	LB05EMH	8160
250 SX	98- 99	250	LB05EMH	8160
250 SX	99-	250	LB05EMH	8160
250 SX	96-	250	LB05EMH	8160
250 SXC	99-	250	LB05EMH	8160

Order-
No.

KTM				
250 SXF	05-	250	VD05EG	
GS 250 12,7 mm		250	LB05F	8051
MC 250 12,7 mm		250	LB05F	8051
MC 250 19,0 mm		250	LB05F	8051
MC 250 GP 12,7 mm		250	LB05F	8051
MC 250 GP 19,0 mm		250	LB05F	8051
300 EGS	99-	300	LB05EMH	8160
300 EXC Enduro Competition	03-	300	LB05EMH	8160
300 EXC / Sixt Days	99-	300	LB05EMH	8160
300 EXC	97- 98	300	LB05EMH	8160
300 MXC	03-	300	LB05EMH	8160
300 SX	99-	300	LB05EMH	8160
360 EXC	97-	360	LB05EMH	8160
360 MXC	97-	360	LB05EMH	8160
360 SX	97-	360	LB05EMH	8160
360 SX	96-	360	LB05EMH	8160
380 Enduro	98-	380	LB05EMH	8160
380 EGS	98-	380	LB05EMH	8160
380 EGS	99-	380	LB05EMH	8160
380 EXC	98-	380	LB05EMH	8160
380 SX	99-	380	LB05EMH	8160
400 Enduro-E	98-	400	SD05F	8022
400 EGS	97-	400	SD05F	8022
400 EGS-E	97-	400	SD05F	8022
400 EXC Racing	99-04.02	400	VD05F	8025
400 EXC Racing	03-	400	VD05EG	
400 LC4	99-04.02	400	SD05F	8022
400 LC4-E	99-04.02	400	SD05F	8022
400 LS-E	97-04.02	400	SD05F	8022
400 SC	98-	400	SD05F	8022
400 SC	96-	400	SD05F	8022
400 SX	98-04.02	400	SD05F	8022
400 SX Racing / Six Days	99-04.02	400	VD05F	8025
400 SXC	98-04.02	400	SD05F	8022
400 SXC	99-04.02	400	SD05F	8022
400 SXC 20kW	99-04.02	400	SD05F	8022
GS 400		400	LB05F	8051
LC4- E 400 Enduro	01-	400	SD05F	8022
LC4 400	98-	400	SD05F	8022
LC4 400 EGS	93-	400	SD05F	8022
LC4 400 EXC	93-	400	SD05F	8022
LC4 Competition	98-	400	SD05F	8022
MC 400		400	LB05F	8051
MC 400 GP		400	LB05F	8051
450 EXC Racing GS	03-	450	VD05EG	
450 EXC Racing	03-	450	VD05EG	
450 MXC Dessert	03-	450	VD05EG	
450 MXC GS	03-	450	VD05EG	
450 SMR	05-	450	VD05EG	
450 SX Racing	03-	450	VD05EG	
GS 500 2Stroke		500	LB05F	8051
GS 500 4Stroke		500	LD05F	8060

Order-
No.**KTM**

MC 500 2Stroke		500	LB05F	8051
MC 500 4Stroke		500	LD05F	8060
520 EXC Racing / Six Days	99- 04.02	520	VD05F	8025
520 SX Racing	99- 04.02	520	VD05F	8025
525 EXC Racing	03-	525	VD05EG	
525 EXC Racing GS	03-	525	VD05EG	
525 MXC	03-	525	VD05EG	
525 MXC Desert Racing	05-	525	VD05EG	
525 SMR	05-	525	VD05EG	
525 SX Racing	03-	525	VD05EG	
540 SXC	98-	540	SD05F	8022
540 SXC	99-	540	SD05F	8022
540 SXC 20kW	99-	540	SD05F	8022
540 SXS Racing	02-	540	VD05F	8025
600 Country		600	LD05F	8060
600 Enduro		600	LD05F	8060
600 MX		600	LD05F	8060
LC4 Enduro 17kW	- 87	600	LD05F	8060
LC4 Enduro 36kW	- 87	600	LD05F	8060
LC4 600 EGS	93-	600	LD05F	8060
LC4 600 EXC	93-	600	LD05F	8060
620 Duke	94-	609	LD05F	8060
LC4 620 SC Supermoto	01- 04.02	609	SD05F	8022
LC4 620 Supercompetition	01- 04.02	609	SD05F	8022
LC4 612 EGS	93-	612	LD05F	8060
LC4 612 EXC	93-	612	LD05F	8060
620 Duke-E	97-	620	SD05F	8022
620 EGS	97-	620	SD05F	8022
620 EGS-E	97-	620	SD05F	8022
620 LS4 Rally	97-	620	SD05F	8022
620 LS-E	97-	620	SD05F	8022
620 SC	98-	620	SD05F	8022
620 SC	96-	620	SD05F	8022
620 Supercompetition	97- 04.02	620	SD05F	8022
620 SX	96-	620	SD05F	8022
620 SX	99-	620	SD05F	8022
LC4 620 EGS	94-	620	SD05F	8022
LC4 620 EXC	94-	620	SD05F	8022
LC4 620 SX	94-	620	SD05F	8022
LC4 Super Competion	00- 04.02	620	SD05F	8022
Supermoto Competition 620	98- 00	620	SD05F	8022
625 SC	02-	625	SD05F	8022
625 SMC	05-	625	VD05EG	
625 SXC Hard Enduro	03-	625	SD05EG	
625 SXC Super Moto	02-	625	SD05F	8022
640 Duke	05-	625	VD05EG	
640 Duke 2	02- 04.02	625	SD05F	8022
640 LC4 SM	05-	625	VD05EG	
640 Supermoto Spezial Edition	03-	625	SD05EG	
Adventure R 640	98- 01	625	SD05F	8022
Duke 2	00- 04.02	625	SD05F	8022
Duke 640	98- 01	625	SD05F	8022

Order-
No.**KTM**

Duke II	99- 01	625	SD05F	8022
640 LC4 Adventure	02- 04.02	625	SD05F	8022
640 LC4-E SM Prestige	02- 04.02	625	SD05F	8022
640 LC4-E Six Days	02- 04.02	625	SD05F	8022
640 LC4	02- 04.02	625	SD05F	8022
LC4- 640 Adventure	01- 04.02	625	SD05F	8022
640 LC4	99- 01	625	SD05F	8022
LC4- E Supermoto	00- 00	625	SD05F	8022
LC4-640 Hard Enduro	03-	625	SD05EG	
LC4 Adventure	00- 00	625	SD05F	8022
LC4 640	98- 00	625	SD05F	8022
LC4- E	00- 00	625	SD05F	8022
LC4- E 640 Enduro	01- 01	625	SD05F	8022
LC4 640 Duke II	03-	625	SD05EG	
640 LC4 Super Moto	02- 04.02	625	SD05F	8022
LC4- E 640 Supermoto	01- 01	625	SD05F	8022
660 Rallye	02- 04.02	650	SD05F	8022
660 Super Moto Factory Replica	02-	650	SD05F	8022
660 LC4 Rallye	99- 01	650	SD05F	8022
Rallye	00- 01	650	SD05F	8022
660 SMC	05-	660	VD05EG	

MAICO

GS 125		125	LBER	8308
MC 125		125	LBER	8308
SG 125		125	LBER	8308
250	94-	250	LBER	8308
GM Star 250		250	LBER	8308
GM Star E 250		250	LBER	8308
GS 250		250	LBER	8308
GSE 250	- 05.83	250	LBER	8308
MC 250		250	LBER	8308
320	94-	320	LBER	8308
GS 400	01.74- 05.83	400	LBER	8308
MC 400		400	LBER	8308
440	94-	440	LBER	8308
GSE 490	- 05.83	490	LBER	8308
MC 490	- 05.83	490	LBER	8308
500	94-	500	LBER	8308
GS 500		500	LBER	8308
GS Star 500		500	LBER	8308
GS Star E 500		500	LBER	8308
MC 500		500	LBER	8308
685 Gespänn	94-	685	LBER	8308

MBK

41		49	LB05F	8051
50 EV		49	LB05F	8051
50 EW		49	LB05F	8051
50 L		49	LB05F	8051
50 S		49	LB05F	8051
50 VL		49	LB05F	8051

Order-
No.**MBK**

50 VS		49	LB05F	8051
51 New West		49	LB05F	8051
51 S		49	LB05F	8051
51 SL		49	LB05F	8051
51 Super		49	LB05F	8051
51 Super Special		49	LB05F	8051
51 V		49	LB05F	8051
51 VL		49	LB05F	8051
88		49	LB05F	8051
88 IP		49	LB05F	8051
88 IU		49	LB05F	8051
89		49	LB05F	8051
Active		49	LB05F	8051
AV 40		49	LB05F	8051
AV 42		49	LB05F	8051
AV 44		49	LB05F	8051
AV 46		49	LB05F	8051
AV 48		49	LB05F	8051
AV 56		49	LB05F	8051
AV 59		49	LB05F	8051
AV 65		49	LB05F	8051
AV 68		49	LB05F	8051
AV 76		49	LB05F	8051
AV 79		49	LB05F	8051
AV 85		49	LB05F	8051
AV 88		49	LB05F	8051
AV 89		49	LB05F	8051
AV 92		49	LB05F	8051
AV 98		49	LB05F	8051
Cady		49	LB05F	8051
CF		49	LB05F	8051
Champ		49	LB05F	8051
Daytona Beach		49	LB05F	8051
Daytona Cruiser		49	LB05F	8051
FXK		49	LB05F	8051
G 40		49	LB05F	8051
G 50		49	LB05F	8051
Hobby IV		49	LB05F	8051
KW Magnum		49	LB05F	8051
M 1		49	LB05F	8051
M 1L		49	LB05F	8051
M 1P		49	LB05F	8051
M 1PR		49	LB05F	8051
M 1PRT		49	LB05F	8051
M 1PRTS		49	LB05F	8051
Mobylett		49	LB05F	8051
N 40		49	LB05F	8051
N 50		49	LB05F	8051
Rock		49	LB05F	8051
SP 50		49	LB05F	8051
SP 92		49	LB05F	8051
SP 93		49	LB05F	8051

Order-
No.**MBK**

SP 94		49	LB05F	8051
SP 98		49	LB05F	8051
SP 99		49	LB05F	8051
Weekly		49	LB05F	8051
X 1		49	LB05F	8051
X 1L		49	LB05F	8051
X 7L		49	LB05F	8051
X 7S		49	LB05F	8051
X 7VL		49	LB05F	8051
X 7VS		49	LB05F	8051
ZX		49	LB05F	8051
151 L	01.79- 07.83	50	LB05F	8051
151 LB	01.79- 07.83	50	LB05F	8051
151 LC	01.79- 07.83	50	LB05F	8051
50 R		50	LB05F	8051
50 VL	01.71- 12.80	50	LB05F	8051
50 VLC	01.71- 12.80	50	LB05F	8051
51 SU	01.81- 07.83	50	LB05F	8051
89	- 07.83	50	LB05F	8051
93		50	LB05F	8051
98	- 07.83	50	LB05F	8051
99		50	LB05F	8051
D50		50	LB05F	8051
Monty MB3V	01.77- 07.83	50	LB05F	8051
Monty SP3V	12.81-	50	LB05F	8051
Monty SP3V	- 11.81	50	LB05F	8051
SP 94 TT		50	LB05F	8051
D75		75	LB05F	8051
125 12,7 mm		125	LB05F	8051
125 19,0 mm		125	LB05F	8051
250		250	LB05F	8051
350	04.73- 04.79	350	LB05F	8051
350 E		350	LB05F	8051
350 Injection		350	LB05F	8051

MONTESA

Brio,Cirlo,Fura,Mini Cota		50	LB05F	8051
Cota 25A/25C/49,Mini Mont.		50	LB05F	8051
Scorpion 50R		50	LB05F	8051
Cota 74 /74T /80		75	LB05F	8051
Crono 75		75	LB05F	8051
Enduro 75 H6 /H7/ L		75	LB05F	8051
Cota 123/C/T, Cota 125		123	LB05F	8051
Cota 172/200		175	LB05F	8051
Cota 348,Trial		310	LB05F	8051
315R	97-	315	LB05F	8051
Cota 330,Trial		330	LB05F	8051
Cota 335/335E/349/349T/350		350	LB05F	8051
Crono 350		350	LB05F	8051
Enduro 360 H6/H7/H7S/L		350	LB05F	8051

Order-
No.**MOTO GUZZI**

250 FD	74- 76	250	LB05F	8060
250 TS	01.74- 07.80	250	LB05F	8051
V 35 II	12.80- 01.87	350	LB05F	8051
V 35 III	07.85-	350	LB05F	8051
V 35 Imola	11.79- 01.87	350	LB05F	8051
V 35 Imola II	79- 86	350	LB05F	8051
V 65 NTX	90- 92	650	LB05F	8051
V 65 Polizia NT		650	LB05F	8051
V 65 SP	- 86	650	LB05F	8051
850 California	12.75- 12.81	850	LB05F	8051
850 Le Mans II / III	01.78- 12.81	850	LB05F	8051
850 T4	07.80- 12.83	850	LB05F	8051
850 T5	06.83- 12.87	850	LB05F	8051
850 TS 5	82- 84	850	LB05F	8051
1000 SP III	88- 92	1000	LB05F	8051

MOTOR HISPANIA

Minicross		50	LB05F	8051
Style		50	LB05F	8051

MZ

Saxon Roadstar	7kW	125	LB05F	8051
Saxon Sportstar	7/11kW	125	LB05F	8051
Saxon Roadstar	9kW	150	LB05F	8051
Saxon Sportstar	9kW	150	LB05F	8051
ETZ Classic	13/15kW	251	LB05F	8051
Saxon 251 Fun	13/15kW	251	LB05F	8051
Saxon 251 Tour	13/15kW	251	LB05F	8051
ETZ 301 Classic	17kW	301	LB05F	8051
Saxon 301 Fun	17kW	301	LB05F	8051
Saxon 301 Tour	17kW	301	LB05F	8051

MZ (TR)

TS 125	01.75- 12.85	125	LB05F	8051
--------	--------------	-----	-------	------

PEUGEOT

101	04.75-	50	LB05F	8051
102	04.75-	50	LB05F	8051
103	04.75-	50	LB05F	8051
103 CRX		50	LB05F	8051
103 LC		50	LB05F	8051
103 LSM-D	06.82-	50	LB05F	8051
103 MP/MR		50	LB05F	8051
103 Racen		50	LB05F	8051
103 SP	86-	50	LB05F	8051
103 SPM-D	04.75-	50	LB05F	8051
103 T16		50	LB05F	8051
103 TXLC, TXR		50	LB05F	8051
103 Vogue		50	LB05F	8051
103 XP, XPLC	01.86-	50	LB05F	8051
104		50	LB05F	8051
105		50	LB05F	8051

Order-
No.**PEUGEOT**

SC80L	06.82-	80	LB05F	8051
SX8T	02.78- 12.82	80	LB05F	8051

PUCH

Cobra 12,9 mm	81-	80	LB05F	8051
Cobra 19,0 mm	81-	80	LB05F	8051

RIEJU

RR 50 AM6		50	LB05F	8051
RS 1		50	LB05F	8051

SACHS

RS 125	97-	125	LB05F	8051
ZX 125	97-	125	LB05F	8051

SUZUKI

A 50 K		50	LB05F	8051
A 50 P		50	LB05F	8051
AE 50	93-	50	LB05F	8051
AJ 50	95-	50	LB05F	8051
AJ 50 ZZ	95-	50	LB05F	8051
AP 50 (CA1JA)	95-	50	LB05F	8051
CL 50 DO		50	LB05F	8051
CP 50 (CA14C/E)		50	LB05F	8051
CP 50 H-J,L/M/N		50	LB05F	8051
CS 50		50	LB05F	8051
CX 50		50	LB05F	8051
CY 50		50	LB05F	8051
DM 50		50	LB05F	8051
DR Big 50	89-	50	LB05F	8051
DV 50		50	LB05F	8051
FA 50		50	LB05F	8051
FR 50		50	LB05F	8051
FS 50		50	LB05F	8051
FZ 50		50	LB05F	8051
GT 50		50	LB05F	8051
JR 50	93- 94	50	LB10EH	31110
JR 50	95-	50	LB10EH	31110
K 50		50	LB05F	8051
Katana AY50 aircooled	97-	50	LB05F	8051
Katana AY50 water (Spain)	97-	50	LB05F	8051
Katana AY50 watercooled	97-	50	LB05F	8051
Maxi 50		50	LB05F	8051
OR 50		50	LB05F	8051
RB 50 GAG	88- 88	50	LD05F	8060
RG 50 KE		50	LB05F	8051
RG 50 W		50	LB05F	8051
RM 50	- 89	50	LB05F	8051
RM 50	90-	50	LB05F	8051
RV 50		50	LB05F	8051
Suzy	95-	50	LB05F	8051
TR 50		50	LB05F	8051

Order-
No.**SUZUKI**

TR 50 S Magic	98-	50	LB05F	8051
TS 50 12,7mm		50	LB05F	8051
TS 50 19,0mm		50	LB05F	8051
TS 50 ER		50	LB05F	8051
TS 50 XK (SA11C)		50	LB05F	8051
ZR 50		50	LB05F	8051
CS 80		80	LB05F	8051
DS 80	93- 94	80	LB05F	8051
DS 80	95-	80	LB05F	8051
FR 80		80	LB05F	8051
GT 80 EX/LX		80	LB05F	8051
RG 80 G (D) (NC11A)		80	LB05F	8051
RG 80 Gamma		80	LB05F	8051
RG 80 WF		80	LB05F	8051
RM 80	93-	80	LB05F	8051
RM 80 H		80	LB05F	8051
RM 80 X	91-	80	LB05F	8051
RM 80 X	- 90	80	LB05F	8051
TS 80 ERX		80	LB05F	8051
TS 80 X (SA11A)		80	LB05F	8051
TS 80 XE-H		80	LB05F	8051
FM 90		90	LB05F	8051
RV 90		90	LB05F	8051
A 100	95-	100	LB05F	8051
FB 100 / D	95-	100	LD05F	8060
GP 100		100	LB05F	8051
TS 100 X	78-	100	LB05F	8051
TS 100 X	- 77	100	LB05F	8051
CS 125		125	LD05F	8060
DR 125 S/L-N	91-	125	LD05F	8060
DR 125 SE (SF44A)	95-	125	LD05F	8060
DR 125 SJ (SF43B)		125	LD05F	8060
GN 125 V (NF41A)	97-	125	LD05F	8060
GN 125	91-	125	LD05F	8060
GP 125		125	LB05F	8051
GS 125 S	99-	125	LD05F	8060
GS 125 S		125	LD05F	8060
GT 125,-E		125	LB05F	8051
RG 125	01.85-	125	LB05F	8051
RM 125	87- 92	125	LB05F/CR2	8051/8048
RM 125	93- 95	125	LB05F/CR2	8051/8048
RM 125	96-	125	LB05F/CR2	8051/8048
RM 125	- 86	125	LB05F/CR2	8051/8048
RC 125		125	LB05F	8051
TS 125 A / B	76- 12.77	125	LB05F	8051
TS 125 R		125	LB05F/CR2	8051/8048
TS 125 ER T, X	80- 83	125	LB05F	8051
TS 125 C, C2	01.78- 78	125	LB05F	8051
TS 125 X		125	LB05F	8051
TS 125 K, L, M	73- 75	125	LB05F	8051
TS 125 N	79- 79	125	LB05F	8051
TS 125 X E	84-	125	LB05F	8051

Order-
No.**SUZUKI**

TS 125 ER N	79- 79	125	LB05F	8051
GT 185		185	LB05F	8051
TS 185 ER	93-	185	LB05F	8051
DR 200 SZ	95-	200	LD05F	8060
GT 200		200	LB05F	8051
TS 200		200	LB05F/CR2	8051/8048
DR 250		250	LD05F	8060
DR 250 S	91-	250	XD05F	8072
DR 250 S (SJ42A)	90-	250	XD05F	8072
DR 250 SZ		250	XD05F	8072
DR 250 SZ-H	95-	250	XD05F	8072
GSX 250 L		250	SD05F	8022
DR 400 S	01.80- 12.83	400	LD05F	8060
GN 400 TD-X		400	LD05F	8060
GS 400 TX		400	VB05F	8032
GSF 400 (BANDIT GK75B)	92-	400	SD05F/CR1	8022/8035
GSF 400 (BANDIT GK75B)	- 92	400	SD05F/CR1	8022/8035
GSX 400 E (GS40X)	01.83-	400	VB05F	8032
GSX 400 FW		400	SD05F/CR1	8022/8035
GSX 400 FX		400	SD05F	8022
GSX 400 LX		400	SD05F	8022
GSX 400 S		400	SD05F	8022
GSX 400 SE/EF (GK53C)		400	SD05F	8022
GSX-R400	93-	400	SD05F/CR1	8022/8035
GSX-R400		400	SD05F/CR1	8022/8035
GS 450 E/ES (GS450)		450	VB05F	8032
GS 450 L (GL51D)		450	VB05F	8032
GS 450 SF		450	VB05F	8032
GS 450 TX		450	VB05F	8032
GS 500 E	- 00	500	XB05F(IN)VB05F(OUT)	8062/8032
GS 500 E (GM51B)	93- 00	500	XD05F(IN)VD05F(OUT)	8072/8052
GSX 550 EF (I)		550	SD05F	8022
GT 550	01.73- 12.77	550	LB05F	8051
DR 600		600	LD05F	8060
DR 600 R Djebel (I)		600	LD05F	8060
DR 600 S (SN41A)		600	LD05F	8060
GR 650 D/XD/XF (GP51A)		650	LD05F	8060
GS 750 D/E/L		750	XB05F(IN)VB05F(OUT)	8062/8032
GSX 750 E		750	SD05F	8022
GSX 750 E (I)		750	SD05F	8022
GSX 750 EF	- 85	750	SD05F	8022
GSX 750 ES (I)		750	SD05F	8022
GSX 750 S		750	SD05F/CR1	8022/8035
GSX 750 S Katana (I)		750	SD05F/CR1	8022/8035
GSX R 750 (GR75A)	- 87	750	XD05F	8072
GSX R 750 (GR77B)	88-	750	XD05F	8072
GSX-R 750 (GR7AB)	91-	750	XD05F	8072
VS 750 GL/H/J-K		750	SD05F	8022
GS 850 G (GS72A)		850	XB05F(IN)VB05F(OUT)	8062/8032
GS 850 GL		850	XB05F(IN)VB05F(OUT)	8062/8032
GS 1000 D/E/H/S-1980/GL/GX		1000	XB05F(IN)VB05F(OUT)	8062/8032
GSX 1100 EFE (I)		1100	SD05F	8022

Order-
No.**SUZUKI**

GSX 1100 EFG/ESG/EG(GV71C)		1100	SD05F	8022
GSX 1100 EZ/ESD (GU71B)		1100	SD05F	8022
GSX 1100 S/SZ Kata.(GS110XS)		1100	SD05F	8022
GSX 1150 E	- 85	1150	SD05F	8022
GSX 1150 E	86-	1150	SD05F	8022
GSX 1150 EF		1150	SD05F	8022
GSX 1150 ES		1150	SD05F	8022

YAMAHA

Golf Car G2A/G9A	92-		LB05F	8051
CA 50 (14T)	83- 87	50	LB05F	8051
CE 50 E		50	LB05F	8051
CH 50		50	LB05F	8051
CR 50 Z/SS	93-	50	LB05F	8051
CV 50		50	LB05F	8051
CW 50	91- 93	50	LB05F	8051
CW 50 (4BX)	94-	50	LB05F	8051
CY 50	94-	50	LB05F	8051
CY 50 E	93-	50	LB05F	8051
CY 50 F	94-	50	LB05F	8051
DT 50		50	LB05F	8051
DT 50 A (F)		50	LB05F	8051
DT 50 E	93-	50	LB05F	8051
DT 50 F	94-	50	LB05F	8051
DT 50 M (S)	86-	50	LB05F	8051
DT 50 M (2M4)	78- 81	50	LB05F	8051
DT 50 M (A) (B)	86-	50	LB05F	8051
DT 50 M (D)	86-	50	LB05F	8051
DT 50 M (NL)	86-	50	LB05F	8051
DT 50 MX (1NN)	01.86-12.89	50	LB05F	8051
DT 50 R (3MN2)(3MN3)(3HL3)(4CT2)(4CT4)(4CT6)	91-	50	LB05F	8051
ES 50		50	LB05F	8051
Fizz (4RC)	95-	50	LB05F	8051
FS 1 DX (3F2)	79- 80	50	LB05F	8051
FS 1 E		50	LB05F	8051
FS 3 M		50	LB05F	8051
GT 50 B		50	LB05F	8051
GT 50 D (FT1)	73- 75	50	LB05F	8051
Jog 50	90-	50	LB05F	8051
LB 2		50	LB05F	8051
LB 2 80	81-	50	LB05F	8051
LB 2 80	- 80	50	LB05F	8051
LB 2 M	81-	50	LB05F	8051
LB 2 M (551)	75- 80	50	LB05F	8051
LB 3 80		50	LB05F	8051
LB 3 M		50	LB05F	8051
LC 50		50	LB05F	8051
LC 50 H		50	LB05F	8051
LC 50 M		50	LB05F	8051
MA 50		50	LB05F	8051
MA 50 M		50	LB05F	8051
MBK Magnum	90-	50	LB05F	8051

Order-
No.**YAMAHA**

MR 50		50	LB05F	8051
MR 50 H		50	LB05F	8051
PW 50 (3PT)	01.87-	50	LB05F	8051
PW 50 E	93-	50	LB05F	8051
PW 50 H / F		50	LB05F	8051
QT 50		50	LB05F	8051
QT 50 H		50	LB05F	8051
RD 50 DX (353)	73- 75	50	LB05F	8051
RD 50 H		50	LB05F	8051
RD 50 MX (2E0)	77- 81	50	LB05F	8051
SA 50		50	LB05F	8051
SA 50 H		50	LB05F	8051
SA 50 M		50	LB05F	8051
SG 50 (34N)	84- 85	50	LB05F	8051
SH 50 / F		50	LB05F	8051
SH 50 E / ED / MF	93-	50	LB05F	8051
T 50		50	LD05F	8060
TY 50 M (1G3)	77- 80	50	LB05F	8051
V 50		50	LB05F	8051
V 50 D	93-	50	LB05F	8051
V 50 E		50	LB05F	8051
V 50 M	- 80	50	LB05F	8051
V 50 M	81- 83	50	LB05F	8051
V 50 M	84-	50	LB05F	8051
YA 50 (5AK)	97-	50	LB05F	8051
YB 50 S		50	LB05F	8051
YE 50	93-	50	LB05F	8051
YZ 50		50	LB05F	8051
YZ 50 H		50	LB05F	8051
RD 60 B		60	LB05F	8051
YB 60		60	LB05F	8051
YZ 60 H		60	LB05F	8051
CW 65	94-	65	LB05F	8051
Active 80	90-	80	LB05F	8051
CH 80		80	LB05F	8051
CV 80		80	LB05F	8051
DT 80 LC-I (37A)	83- 86	80	LB05F	8051
DT 80 LC-II (53V)	84-	80	LB05F	8051
DT 80 MX (5J1)	81- 84	80	LB05F	8051
DT 80 MX-S (5T8)	83- 86	80	LB05F	8051
FS 80		80	LB05F	8051
FS 80 SE (5A7)	81- 82	80	LB05F	8051
GT 80 (477)	74- 75	80	LB05F	8051
GT 80 D		80	LB05F	8051
GT 80 E		80	LB05F	8051
LB 80		80	LB05F	8051
LB 80 2A		80	LB05F	8051
LB 80 2AC		80	LB05F	8051
LB 80 2AD		80	LB05F	8051
LB 80 2H		80	LB05F	8051
LB 80 2HD		80	LB05F	8051
LB 80 3 (1M9)	78- 79	80	LB05F	8051

Order-
No.**YAMAHA**

LB 80 3D		80	LB05F	8051
MX 80		80	LB05F	8051
MX 80 H		80	LB05F	8051
PW 80 (21W)	83- 90	80	LB05F	8051
PW 80 E / F (4BC..)	93-	80	LB05F	8051
RD 80 LC-II (30W)	83- 87	80	LB05F	8051
RD 80 MX (5G1)	81- 82	80	LB05F	8051
RX 80 SE (12N)	82- 83	80	LB05F	8051
T 80		80	LD05F	8060
TY 80		80	LB05F	8051
V 80		80	LB05F	8051
V 80 H / D		80	LB05F	8051
Y 80		80	LB05F	8051
Y 80 E		80	LB05F	8051
YB 80		80	LB05F	8051
YE 80 (4MU)	94-	80	LB05F	8051
YZ 80	84- 85	80	LB05F	8051
YZ 80 (4GT)	95-	80	LB05F	8051
YZ 80 (1LR)	86-	80	LB05F	8051
YZ 80 B		80	LB05F	8051
YZ 80 C		80	LB05F	8051
YZ 80 D		80	LB05F	8051
YZ 80 E	- 92	80	LB05F	8051
YZ 80 E / F/LW(4LB)/ LWF	93-	80	LB05F	8051
YZ 80 H	- 83	80	LB05F	8051
YZ 80 H.R.		80	LB05F	8051
YZ 80 L.R.		80	LB05F	8051
YA 90 E / F	93-	90	LB05F	8051
AG 100		100	LB05F	8051
AG 100 H / E / F		100	LB05F	8051
DT 100		100	LB05F	8051
DT 100 B		100	LB05F	8051
DT 100 C		100	LB05F	8051
DT 100 D		100	LB05F	8051
DT 100 E		100	LB05F	8051
DT 100 H		100	LB05F	8051
DT 100 SD		100	LB05F	8051
DT 100 X		100	LB05F	8051
DX 100		100	LB05F	8051
DX 100 H		100	LB05F	8051
MX 100	79-	100	LB05F	8051
MX 100 B		100	LB05F	8051
MX 100 H		100	LB05F	8051
RS 100 B		100	LB05F	8051
RS 100 DX (1Y8)	76- 81	100	LB05F	8051
RS 100 P		100	LB05F	8051
RS 100 S		100	LB05F	8051
RS 100 X		100	LB05F	8051
RT 100 E / F	93-	100	LB05F	8051
RX 100 12,7mm		100	LB05F	8051
RX 100 19,0mm		100	LB05F	8051
RXS 100		100	LB05F	8051

Order-
No.**YAMAHA**

RX-ZD	93-	100	LB05F	8051	
V 100/E/S/SH	93-	100	LB05F	8051	
YB 100	94-	100	LB05F	8051	
YB 100 M		100	LB05F	8051	
YB 100 P		100	LB05F	8051	
YZ 100	-	83	100	LB05F	8051
YZ 100 E		100	LB05F	8051	
YZ 100 H		100	LB05F	8051	
V 110 E	93-	110	LB05F	8051	
RX 115	93-	115	LB05F	8051	
V 120 JR / ZR	94-	120	LB05F	8051	
BL 125 (50W)	85- 89	125	LB05F	8051	
DT 125	94-	125	LB05F	8051	
DT 125 E (1G0)	77- 79	125	LB05F	8051	
DT 125 E (AT2)	73- 76	125	LB05F	8051	
DT 125 ED		125	LB05F	8051	
DT 125 F		125	LB05F	8051	
DT 125 H		125	LB05F	8051	
DT 125 LC	86-	125	LB05F	8051	
DT 125 LC (10V)	82- 85	125	LB05F	8051	
DT 125 MX		125	LB05F	8051	
DT 125 R (4BL) / RE (3RM)	91-	125	LB05F/CR2	8051/8048	
DT 125 Tenere (I)		125	LB05F	8051	
IT 125		125	LB05F	8051	
IT 125 H		125	LB05F	8051	
MX 125		125	LB05F	8051	
R 125 SE		125	LB05F	8051	
RD 125 12,7mm		125	LB05F	8051	
RD 125 19,0mm		125	LB05F	8051	
RD 125 C		125	LB05F	8051	
RD 125 C-DX		125	LB05F	8051	
RD 125 D		125	LB05F	8051	
RD 125 D-DX (AS3)	73- 75	125	LB05F	8051	
RD 125 LC	84-	125	LB05F	8051	
RD 125 LC (10W)	82- 83	125	LB05F	8051	
RS 125 DX		125	LB05F	8051	
RS 125 E		125	LB05F	8051	
RS 125 P		125	LB05F	8051	
RS 125 Z		125	LB05F	8051	
RX 125 12,7mm		125	LB05F	8051	
RX 125 19,0mm		125	LB05F	8051	
RX 125 H		125	LB05F	8051	
SR 125		125	LD05F	8060	
SR 125 (10F)	97-	125	LD05F	8060	
SR 125 Z	93-	125	LD05F	8060	
TA 125 (400)	73- 75	125	LB05F	8051	
TA 125 A		125	LB05F	8051	
TDR 125 (4GW)	92-	125	LB05F	8051	
TDR 125 (5AN)	97-	125	LB05F	8051	
TY 125 (1K6)	77- 81	125	LB05F	8051	
TZ 125 (4JT)	95-	125	LB05F	8051	
TZ 125 (3V3)	80-	125	LB05F	8051	

Order-
No.**YAMAHA**

TZ 125 / F	94-	125	LB05F	8051
TZ 125 H		125	LB05F	8051
TZR 125	- 92	125	LB05F/CR2	8051/8048
TZR 125	93-	125	LB05E	8031
XT 125		125	LD05F	8060
XV 125 (5AJ)	97-	125	LD05F	8060
YB 125		125	LB05F/CR2	8051/8048
YS 125		125	LB05F	8051
YZ 125		125	LB05F/CR2	8051/8048
YZ 125 B		125	LB05F	8051
YZ 125 C		125	LB05F	8051
YZ 125 E		125	LB05F	8051
YZ 125 E / E1 / F	93-	125	LB05F	8051
YZ 125 H		125	LB05F	8051
YZ 125 X		125	LB05F	8051
FZ 150	94-	150	LD05F	8060
FZR 150	94-	150	LD05F	8060
RX 150	93-	150	LB05F	8051
SR 150	93-	150	LD05F	8060
DT 165 R	91-	165	LB05F	8051
AG 175		175	LB05F	8051
AG 175 H		175	LB05F	8051
DT 175 (CT1)	74- 75	175	LB05F	8051
DT 175 E / F		175	LB05F	8051
DT 175 H		175	LB05F	8051
DT 175 MX (2K4)	09.78- 12.81	175	LB05F	8051
IT 175 (5Y0)	83- 84	175	LB05F	8051
IT 175 E		175	LB05F	8051
IT 175 H		175	LB05F	8051
MX 175		175	LB05F	8051
MX 175 B		175	LB05F	8051
MX 175 H		175	LB05F	8051
TY 175		175	LB05F	8051
TY 175 E		175	LB05F	8051
TY 175 J		175	LB05F	8051
YZ 175		175	LB05F	8051
RT 180 E	93-	180	LB05F	8051
XC 180 (32H)	83- 84	180	LD05F	8060
SH 185 H		185	LD05F	8060
RS 195		195	LB05F	8051
AG 200 E / F	93-	200	LD05F/CR2	8060/8048
BW 200		200	LD05F	8060
DT 200 LC / RE / RF	93-	200	LB05F	8051
DT 200 R		200	LB05F/CR2	8051/8048
IT 200 S		200	LB05F	8051
NR 200		200	LB05F	8051
RD 200 12,7mm		200	LB05F	8051
RD 200 19,0mm (397)		200	LB05F	8051
RD 200 C		200	LB05F	8051
RD 200 C-DX		200	LB05F	8051
RD 200 D		200	LB05F	8051
RD 200 D-DX (1E8)	77- 80	200	LB05F	8051

Order-
No.**YAMAHA**

RS 200		200	LB05F	8051
TW 200	01.87-	200	LD05F	8060
TW 200 E / EC / F	93-	200	LD05F	8060
TW 200 FC	94-	200	LD05F	8060
WR 200 R / RE / RF	93-	200	LB05F	8051
XT 225 E / EC / F / FC	93-	225	LD05F	8060
TDR 240		240	LB05F	8051
XV 240		240	LD05F	8060
DT 250 (512)	75- 76	250	LB05F	8051
DT 250 E		250	LB05F	8051
DT 250 H		250	LB05F	8051
DT 250 MX (1R7)	77- 81	250	LB05F	8051
IT 250 (45J)	85-	250	LB05F	8051
IT 250 (4V5)	81-	250	LB05F	8051
IT 250 J		250	LB05F	8051
IT 250 K		250	LB05F	8051
IT 250 N		250	LB05F	8051
MX 250		250	LB05F	8051
R1-Z	93-	250	LB05F/CR2	.../8048
RD 250 (522)	75-	250	LB05F	8051
RD 250 D		250	LB05F	8051
RD 250 LC (4L1)	80- 83	250	LB05F	8051
SE 250 (I)		250	LB05F	8051
SR 250 (I)		250	LB05F	8051
SR 250 H / F		250	LB05F	8051
SR 250 SE (3Y8)	80- 82	250	LB05F	8051
SR 250 TH		250	LB05F	8051
TDR 250 (3CK)	88- 89	250	LB05F	8051
TRD 250 (I)		250	LB05F	8051
TT 250		250	LB05F	8051
TT 250 R / RF	94-	250	LB05F/CR2	8051/8048
TY 250 (38V)	84- 87	250	LB05F	8051
TY 250 (3BA)	88- 90	250	LB05F	8051
TY 250 (S16)	75- 79	250	LB05F	8051
TY 250 Z (4GG)	94- 96	250	LB05F	8051
TZ 250	- 83	250	LB05F	8051
TZ 250	84-	250	LB05F	8051
TZ 250 (4DP)	95-	250	LB05F	8051
TZ 250 / F	94-	250	LB05F	8051
TZ 250 E	- 83	250	LB05F	8051
TZ 250 E/E1	93-	250	LB05F	8051
TZ 250 H	- 83	250	LB05F	8051
TZR 250 "V2"	91- 95	250	LB05E	8051
TZR 250 (2MA)	87- 89	250	LB05F	8051
TZR 250R/RS/RSP	93-	250	LB05E	8051
WR 250 Z / ZE / ZF (4JW)	93-	250	LB05E	8031
XS 250 (1V5)	78- 79	250	LB05F	8051
XS 250 C		250	LB05F	8051
XS 250 H		250	LB05F	8051
XS 250 RH	- 83	250	LB05F	8051
XS 250 SE		250	SD05F/CR1	8022/8035
XS 250 SH		250	SD05F/CR1	8022/8035

Order-
No.**YAMAHA**

XT 250 (3Y3)	80-	82	250	SD05F	8022
XT 250 H	-	84	250	LB05F	8051
XV 250	94-		250	LD05F	8060
XV 250 (3LS,3LW)	89-		250	LD05F	8060
XV 250 F	94-		250	LD05F	8060
XV 250 S (3LW)	95-		250	LD05F	8060
YZ 250 (4MX)	95-		250	LB05F	8051
YZ 250 (2VM,3JE,3SP,3XK)	88-	91	250	LB05F	8051
YZ 250 (39X,56A,1LU,2HH)	84-	87	250	LB05F	8051
YZ 250 (4DA,4EW)	92-		250	LB05F	8051
YZ 250 (5X5,24Y)	82-	83	250	LB05F	8051
YZ 250 F	94-		250	LB05F	8051
BW 350			350	LD05F	8060
TZ 350 B			350	LB05F	8051
TZ 350 H			350	LB05F	8051
XT 350 (3YT)	91-		350	LD05F	8060
XT 350 (55V)	85-	90	350	LD05F	8060
XT 350 E / F	93-		350	LD05F	8060
DT 360 (RT2)	01.73-	12.75	360	LB05F	8051
MX 360			360	LB05F	8051
YZ 360			360	LB05F	8051
DT 400 (513)	11.75-	12.76	400	LB05F	8051
DT 400 E			400	LB05F	8051
DT 400 H			400	LB05F	8051
DT 400 MX (1R6)	77-	80	400	LB05F	8051
FZR 400	04.87-		400	SD05F/CR1	8022/8035
IT 400			400	LB05F	8051
IT 400 E			400	LB05F	8051
MX 400			400	LB05F	8051
RD 400 (1A3)	76-	79	400	LB05F	8051
RD 400 E			400	LB05F	8051
SR 400			400	LB05F/CR2	8051/8048
TT 400 C			400	LB05F	8051
XJ 400			400	XD05F	8072
XT 400	84-		400	LD05F	8060
XV 400 SE			400	XB05F	8062
YZ 400			400	LB05F	8051
YZ 400 C			400	LB05F	8051
YZ 400 E			400	LB05F	8051
IT 425			425	LB05E	8031
IT 465 (4V6)	81-		465	LB05E	8031
IT 465 H			465	LB05E	8031
YZ 465			465	LB05E	8031
YZ 465 H			465	LB05E	8031
IT 490 (29W)	83-	85	490	LB05F	8051
YZ 490			490	LB05F	8051
IT 500			500	LB05F	8051
RD 500 LC (1GE)	85-	86	500	LB05F	8051
RD 500 LC (47X)	-	84	500	LB05F	8051
SR 500 (3EB)	95-		500	LB05F/CR2	8051/8048
SR 500 (2J4,48T)	01.79-	96	500	LB05F/CR2	8051/8048
SR 500 (48T)	97-		500	LB05F/CR2	8051/8048

Order-
No.**YAMAHA**

SR 500 E			500	LB05F/CR2	8051/8048
SR 500 H			500	LB05F/CR2	8051/8048
XJ 500			500	XD05F	8072
XT 500 (1E6,1V6)	76-	89	500	LB05F	8051
XT 500 C			500	LB05F	8051
XT 500 E	-	92	500	LB05F	8051
XT 500 H			500	LB05F	8051
XV 500 (I)			500	XB05F	8062
XV 500 SE (26R)	83-	87	500	XB05F	8062
XT 550 (5Y3)	82-	83	550	LD05F	8060
XZ 550 (11V)	82-	84	550	LD05F	8060
XZ 550 S (11V)	83-	84	550	LD05F	8060
SRX 600 (1XM,1XN)	86-	89	600	SD05F/CR1	8022/8035
XT 600 (2KF,2NF)	87-	90	600	XD05F	8072
XT 600 (43F)	84-	87	600	XD05F	8072
XT 600 E (4PT / 4SK)	95-		600	LD05F	8060
XT 600 E / EF / EFC	94-		600	LD05F	8060
XT 600 E(h) (3TB)	97-		600	LD05F	8060
XT 600 E(m) (3UW)	97-		600	LD05F	8060
XT 600 E/K (3TB/3UW)	90-	94	600	LD05F	8060
XJ 650 (4K0)	80-	83	650	XB05F	8062
XJ 650 H			650	XB05F	8062
XJ 650 LH			650	XB05F	8062
XJ 650 SH			650	XB05F	8062
XJ 650 T (Turbo) (11T)	82-		650	XB05F	8062
XS 650 (447)	76-	83	650	XB05F	8062
XS 650 (I)			650	XB05F	8062
XS 650 E			650	XB05F	8062
XS 650 H			650	XB05F	8062
XS 650 II			650	XB05F	8062
XS 650 S			650	XB05F	8062
XS 650 SE (3L1)	79-	81	650	XB05F	8062
XS 650 SH			650	XB05F	8062
FZ 750 (1FN)	85-	86	750	SD05F/CR1	8022/8035
FZ 750 (3KT)	91-		750	SD05F/CR1	8022/8035
FZ 750 Genesis (2KK)	87-	90	750	SD05F/CR1	8022/8035
TZ 750			750	LB05F	8051
TZ 750 D			750	LB05F	8051
XJ 750	-	83	750	LB05F/CR2	8051/8048
XJ 750 (41Y)	84-	85	750	LB05F/CR2	8051/8048
XJ 750 RH			750	LB05F/CR2	8051/8048
XS 750 (1T5)	77-	79	750	XB05F	8062
XS 750 C			750	XB05F	8062
XS 750 D			750	XB05F	8062
XS 750 E			750	XB05F	8062
XS 750 S			750	XB05F	8062
XS 750 SE			750	XB05F	8062
XS 750 T			750	XB05F	8062
XTS 750 SE			750	XB05F	8062
XV 750	-	83	750	XB05F	8062
XV 750 (4PW)	95-		750	XB05F	8062
XS 850 (4E2)	80-	81	850	XB05F	8062

Order-
No.**APRILIA**

Scarabeo 50	93- 03	50	LB05F	8051
Scarabeo De Luxe	98- 03	50	LB05F	8051

CCF

Cat 50	97-	50	LB05FP	8030
--------	-----	----	--------	------

DAELIM

VC 125	97-	125	XB01F	30275
VS 125	97-	125	XB01F	30275

HONDA

Joker SRX50T	97-	50	LB05F	8051
NB 50		50	LB05F	8051
NB 50 M Melody (AB07)	84-	50	LB05F	8051
NH 50 M	93-	50	LB05F	8051
NH 50 MS Lead (AF01)	85- 87	50	LB05F	8051
PK 50 Wallaro	90-	50	LB05F	8051
PX 50	89- 90	50	LB05F	8051
SA 50 Vision	01.88- 90	50	LB05F	8051
SFX 50	95-	50	LB05F	8051
SGX 50 Sky	97-	50	LB05F	8051
SH 50 P	01.93- 95	50	LB05F	8051
SH 50 T	96-	50	LB05F	8051
SH 50 (AF40)	97-	50	LB05F	8051
SH 50 (I)	01.87- 96	50	LB05F	8051
SJ 50 Bali		50	LB05F	8051
NH 80 MS Lead (HD01)	83-	80	LB05F	8051
SH 100 T	01.96-	100	LB05F	8051
SJ 100 Bali	01.96-	100	LB05F	8051
CH 125	01.86- 95	125	LD05F	8060
CH 125 P	-01.93	125	LD05F	8060
NH 125 D Lead	83-	125	LB05F	8051
Spacy CH 125 (JS03)	97-	125	LD05F	8060
CN 250	01.86-	250	VD05F	8052
CN 250 Fusion		250	VD05F	8052
CN 250 Helix (MF02)	01.87- 99	250	VD05F	8052

ITALJET

Dragster 50	97- 98	50	LB10F	31125
Dragster 50	96- 97	50	LB10F	31125
Dragster 50	98-	50	LB10F	31125
Fastboy	98-	50	LB05F	8051
Formula 50 watercool	98-	50	LB05F	8051
Formula 50 aircool	98-	50	LB05F	8051
Torpedo 25	97-	50	LB10F	31125
Dragster 125	97- 97	125	LB05F	8051
Formula 125	97- 98	125	LB05F	8051
Formula 125	98-	125	LB05F	8051

KTM

Chrono 50		50	LB05F	8051
Go 50		50	LB05F	8051

Order-
No.

KTM				
K 50 (I)		50	LB05F	8051
KYMCO				
Calypso 50	97-	50	VD05F	8052
Calypso 125	97-	125	VD05F	8052
K-ZWO				
Cat 50	97-	50	LB05FP	8030
PEUGEOT				
Speedfight LC	96-	50	LB05E	8031
Speedfight M	96-	50	LB05E	8031
SV 50	96-	50	LB05E	8031
Trekker Road		50	LB05E	8031
Trekker Off Road	98-	50	LB05E	8031
Speedfight 100	96- 03	100	LB05E	8031
SV 100	96-	100	LB05E	8031
Trekker 100	98-	100	LB05E	8031
PGO				
Big Max 25/50		50	LB05F	8051
Big Max 50		50	LB05F	8051
Big Max Sport 50	96-	50	LB05F	8051
Comet		50	LB05F	8051
Galaxy 25		50	LB05F	8051
Galaxy 50		50	LB05F	8051
Mega 50	96-	50	LB05F	8051
PMS 50	99-	50	LB05F	8051
PMX 50	99-	50	LB05F	8051
Rodoshow	02.00-	50	LB05F	8051
Star 2		50	LB05F	8051
Star 50		50	LB05F	8051
Tornado 50	97-	50	LB05F	8051
T-REX 50	99-	50	LB05F	8051
Star 80		80	LB05F	8051
Big Max 90	96-	82	LB05F	8051
T-REX 125 2T	99-	125	LB05F	8051
T-REX 125 4T	99-	125	YB05F	8082
PIAGGIO				
Free 25 Mofa		25	LB05F	8051
Zip 25 Mofa		25	LB05F	8051
Zip Base 25 / Mofa		25	LB05F	8051
50 R, Special		50	LB05F	8051
50 S		50	LB05F	8051
Boss		50	LB05F	8051
Bravo - Si / Moped		50	LB05F	8051
Bravo PV		50	LB05F	8051
Bravo P		50	LB05F	8051
Ciao M Kat		50	LB05F	8051
Ciao Mix / Mix		50	LB05F	8051
Ciao V Kat		50	LB05F	8051

Order-
No.**PIAGGIO**

Ciao-Bravo SI / Mofa		50	LB05F	8051
Eaglet		50	LB05F	8051
Free 50	93-	50	LB05F	8051
Grillo / Mofa		50	LB05F	8051
NRG mc2 DT,DD		50	LB05F	8051
NRG Extreme Kat		50	LB05F	8051
NRG Extreme		50	LB05F	8051
NRG mc2 50	01.96-	50	LB05F	8051
NRG		50	LB05F	8051
NRG H ⁰ Kat		50	LB05F	8051
PK 50 S Auto		50	LB05F	8051
PK 50 XL2 Auto		50	LB05F	8051
PK 50	09.82-12.87	50	LB05F	8051
PK 50 S	09.82-12.87	50	LB05F	8051
PK 50 XL 2		50	LB05F	8051
PK 50 SS		50	LB05F	8051
Plurimatic		50	LB05F	8051
PX 50		50	LB05F	8051
Quarz 50 Automatic	06.92-	50	LB05F	8051
Sfera 50 Automatico	01.91-	50	LB05F	8051
Sfera 50 , FL, RL, RST		50	LB05F	8051
Storm Automatic	94-	50	LB05F	8051
Super Bravo / Mofa		50	LB05F	8051
Super Bravo 2 Gang / Mofa		50	LB05F	8051
TPH	93-	50	LB05F	8051
Velofax / Mofa		50	LB05F	8051
Vespa PK 50 XL 2 ,Automatic		50	LB05F	8051
Vespa Elestart		50	LB05F	8051
Vespa HP 4M		50	LB05F	8051
Vespa Delta,Puch Condor		50	LB05F	8051
Vespa Vale Especial/Standard		50	LB05F	8051
Vespino		50	LB05F	8051
Vespino NX/SC/T/TL/TN/TS		50	LB05F	8051
Vespino TX/XE		50	LB05F	8051
Zip 50 Fast Rider	01.93-	50	LB05F	8051
Zip 50 SP		50	LB05F	8051
Zip Base 50		50	LB05F	8051
Zip 50	01.92-	50	LB05F	8051
Zip & Zip (Hybrid)	94-	50	LB05F	8051
Vespa PK 75S/Elestart/Junior		75	LB05F	8051
Vespa PK 75XL/ Elestart		75	LB05F	8051
Vespa PK 75S Primavera / T3 Prima.		75	LB05F	8051
PK 80 S	09.82-12.85	80	LB05F	8051
PX 80 E Lusso		80	LB05F	8051
PX 80 E,P 80 X		80	LB05F	8051
Sfera 80 Automatic		80	LB05F	8051
TPH Automatic	94-	80	LB05F	8051
PK 100 S	06.82-	100	LB05F	8051
125 T5	03.85-	125	LB05F	8051
Ape		125	LB05F	8051
Cosa FL 125	91-	125	LB05F	8051
Cosa 125 MA AE	01.88-	125	LB05F	8051

Order-
No.**PIAGGIO**

Cosa 200 FL EBC 12PS		125	LB05F	8051
Cosa 125	- 91	125	LB05F	8051
ET 3		125	LB05F	8051
ET 4 Automatic		125	LB05F	8051
Hexagon LX 125	94-	125	LB05F	8051
P 125 ETS	01.83-12.85	125	LB05F	8051
PK 125, E, S		125	LB05F	8051
PK Automatic		125	LB05F	8051
PK 125 XL Automatic		125	LB05F	8051
PK 125 XL 2		125	LB05F	8051
Primavera	01.76-12.83	125	LB05F	8051
PX 125 E Lusso	01.82-	125	LB05F	8051
Sfera RST 4 Takt	95-	125	LB05F	8051
Sfera 125	01.95-	125	LB05F	8051
Skipper 125 LX	01.93-	125	LB05F	8051
SKR 125	08.93-	125	LB05F	8051
TPH	95-	125	LB05F	8051
Vespa XL 125 Plurimat/Elestart		125	LB05F	8051
Vespa T5		125	LB05F	8051
Vespa PX 125 Kat		125	LB05F	8051
Vespa PK 125	85-	125	LB05F	8051
Vespa 125 FL2	01.90-	125	LB05F	8051
Vespa 125 CL/LS/NK Primavera		125	LB05F	8051
Vespa 125 T5 Sport/Elestart		125	LB05F	8051
Vespa T3Li/T3		125	LB05F	8051
Vespa ET4 125	01.96-	125	LB05F	8051
Vespa Special ET3 Primavera		125	LB05F	8051
Vespa PX 125 MA AE	86-	125	LB05F	8051
EX 150 (Hexagon)	94-	150	LB05F	8051
Hexagon 150	01.94-	150	LB05F	8051
PX 150 E Lusso	01.82-	150	LB05F	8051
Skipper 150	01.93-	150	LB05F	8051
SKR 150	98-	150	LB05F	8051
Vespa PX 150 MA AE	86-	150	LB05F	8051
Vespa PX 150 Kat		150	LB05F	8051
Vespa 150 long 12,7 mm		150	LB05F	8051
Vespa 150 long 19,0 mm		150	LB05F	8051
Vespa 160/ GT		160	LB05F	8051
Vespa 175		175	LB05F	8051
Vespa SS		180	LB05F	8051
Ape		190	LB05F	8051
Cosa FL 200	91-	200	LB05F	8051
Cosa 200 MA AE	01.88-	200	LB05F	8051
Cosa 200 Aluzyl.12PS	93- 97	200	LB05F	8051
Cosa 2 200	01.88- 91	200	LB05F	8051
PX 200 E Lusso	01.84-	200	LB05F	8051
PX 200 E Grand-Sport	01.84-	200	LB05F	8051
Vespa PX 200E/Iris/ Elestart		200	LB05F	8051
Vespa PX 200 MA AE	86-	200	LB05F	8051
Vespa 200 TX/ Elestart		200	LB05F	8051
Vespa 200 DN/ DS/ E		200	LB05F	8051
Ape		220	LB05F	8051

Order-
No.**PIAGGIO**

Hexagon GT 250 4Takt	98-	250	VD05F	8052
----------------------	-----	-----	-------	------

PUCH

Lido		50	LB05F	8051
Lido 125		125	LB05F	8051

SACHS

Speedfight 50 AC	97-	50	LB05F	8051
Speedfight 50 LC	97-	50	LB05F	8051
Speedfight 50 LC ADT	97-	50	LB05F	8051

SIAM

Falkon 50	97-	50	LB05FP	8030
-----------	-----	----	--------	------

SUZUKI

AH 50 Adress (CA1GA)	92-	50	LB05F	8051
AH 50 GP	95-	50	LB05F	8051
AJ 50 ZZ (I)	95-	50	LB05F	8051
AP 50 S CA1JA)	95-	50	LB05F	8051
AP 50 T (I)	96-	50	LB05F	8051
CP 50 (I)	89- 92	50	LB05F	8051
AH 100 (I)	- 93	100	LB05F	8051
AH 100 (CE12A)	95-	100	LB05F	8051
AN 125 (CF42A)	95- 95	125	LD05F	8060
AN 125 (CF42A)	96-	125	LD05F	8060
AN 150 T (I)	01.96-	150	LD05F	8060

YAMAHA

Aerox	97-	50	LB05F	8051
Axis (YA50R) (3UG)	97-	50	LB05F	8051
Axis Mofa (5AK)(YA50R)	97-	50	LB05F	8051
Breeze (4RC)(YM50)	95-	50	LB05F	8051
BW 50 Spy (CW50RSP;4VA)	96-	50	LB05F	8051
BW 50 (4BX)	91- 95	50	LB05F	8051
BW 50 (CW50)	96-	50	LB05F	8051
BW 50 Bump (CW50RSX)	96-	50	LB05F	8051
BW 50 NG (CW50RS;4VA)	96-	50	LB05F	8051
BW 50 R (4BX)	96-	50	LB05F	8051
CR 50 Z (I)		50	LB05F	8051
CT 50 S (I)		50	LB05F	8051
CT 50 SS (I)		50	LB05F	8051
CW 50 R (4BX)		50	LB05F	8051
Evolis (YE50)(4FW)		50	LB05F	8051
Forte (YA50R) (3UG)		50	LB05F	8051
Jog-Z 50 (I)	01.95-	50	LB05F	8051
Neo's	97-	50	LB05F	8051
Spy 50 (I)		50	LB05F	8051
YA 50 (5AK)	97-	50	LB05F	8051
Zest/ YE50 (4FW)		50	LB05F	8051
Evolis (4MU)		80	LB05F	8051
Zest (4MU)(YE80)		80	LB05F	8051
BL 125 (50W)	85- 89	125	LB05F	8051

Order-
No.**HONDA**

TRX 70			70	LD05F	8060
TRX 90	93-	94	90	LD05F	8060
TRX 90	95-		90	LD05F	8060
ATC 125 M			125	LD05F	8060
TRAX 125			125	LD05F	8060
TRX 125			125	VD05F	8052
ATC 185			185	LD05F	8060
ATC 185 S			185	LD05F	8060
ATC 200			200	VD05F	8052
TRX 200 D	92-		200	VD05F	8052
ATC 250 ES /SX	85-		250	VD05F	8052
TRX 250			250	VD05F	8052
TRX 250 R			250	VD05F	8052
TRX 250 X			250	VD05F	8052

KAWASAKI

KLF 185			185	LD05F	8060
KLF 220	88-	02	220	LD05F	8060
KDX 250			250	LBER	8308
KDX 250	91-		250	LB05F	8051
KDX 250 SR	92-		250	LB05F	8051
KEF 300 A&B (SQ)	95-		300	LD05F	8060
KLF 300	88-		300	LB05F	8051

POLARIS

Big Boss	89-	93	250	LB05EZ	8744
Cyclone	88-	89	250	LB05EZ	8744
Scrambler	89-	93	250	LB05EZ	8744
Trail Blazer	90-		250	LB05EZ	8744
Trail Boss	85-		250	LB05EZ	8744
Xplorer 300	94-		283	LB05EZ	8744
Xpress 300	94-		283	LB05EZ	8744
Sportsman 335	99-		334	LB05EZ	8744
Big Boss	93-		350	LB05EZ	8744
Trail Boss	90-	93	350	LB05EZ	8744
Big Boss 400L (6X6)	95-	97	379	LB05EZ	8744
Scambler 400 (4X4)	94-		379	LB05EZ	8744
Sport 400	98-		379	LB05EZ	8744
Sport ATV	95-	97	379	LB05EZ	8744
Sportsman 4x4	94-	97	379	LB05EZ	8744
Xplorer 400/400L 4x4	94-		379	LB05EZ	8744
Xpress 400 L 2x4	96-	97	379	LB05EZ	8744
Magnum (2X4)	95-		425	LB05EZ	8744
Magnum (4X4)	95-		425	LB05EZ	8744
Magnum (6X6)	96-	97	425	LB05EZ	8744
Big Boss 500 (6X6)	98-		500	LB05EZ	8744
Magnum 500	99-		500	LB05EZ	8744
Ranger	99-		500	LB05EZ	8744
Scrambler 500	98-		500	LB05EZ	8744
Sportsman 500	96-	04	500	LB05EZ	8744
Xplorer 500	97-		500	LB05EZ	8744



Order-
No.

				SUZUKI
LT 50			50	LB05F 8051
LT 80			80	LB05F 8051
LT 160 E	-	92	160	LD05F 8060
LT 160 E		93-	160	LD05F 8060
LT 160 F		93-	160	LD05F 8060
LT-F 160		95-	160	LD05F 8060
LT 230 E		93-	230	LD05F 8060
LT 230 E/F			230	LD05F 8060
LT 230 GE			230	LD05F 8060

				YAMAHA
YF 60 (1HN)		87- 88	60	LB05F 8051
YFM 80			80	LD05F 8060
YFM 80 W Raptor		02-	80	LD05F 8060
YFM 80 W Badger		02-	80	LD05F 8060
YFM 80 E / F		93-	80	LD05F 8060
YFA 1 Breeze		89- 04	125	LD05F 8060
YFA 1 F		94-	125	LD05F 8060
YT 125			125	LB05F 8051
YT 125 CH			125	LB05F 8051
YT 125 H			125	LB05F 8051
YT 175			175	LB05F 8051
YFM 200		92-	200	LD05F 8060
YFM 200 (52H)		85- 86	200	LD05F 8060
YFM 225 (2HT)			200	LD05F 8060
YFM 225 (59V)			200	LD05F 8060
YFS 200 Blaster		90- 04	200	LB05F 8051
YFS 200 E / F		93-	200	LB05F 8051
TT 225			225	LD05F 8060
YFM 225 59V/2HT		92-	225	LD05F 8060
YFB 250 / E / F / FWF		93-	250	LD05F 8060
YFB 250 / FW		94-	250	LD05F 8060
YFM 250 Timberwolf			250	LD05F 8060
YFM 250 (3GH)		90-	250	LD05F 8060



NGK Racing Cables



Bestell-Nr.	Kabel-Länge cm	Stecker-Typ
CR1	50	SD05FM
CR2	50	LZ05FM
CR3	50	SD05EMK
CR4	50	TB05EMA
CR5	100	LZ05FM
CR6	100	TB05EMA



CR1 + CR3



CR2 + CR4
CR5 + CR6



NGK Zündkerzenstecker mit Kabel





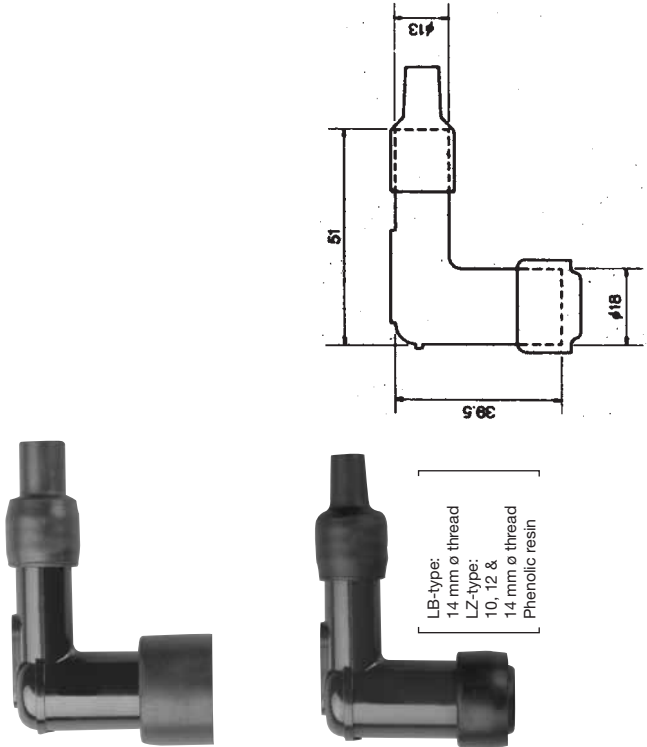

Bestell-Nr.	Kabel-Länge cm	Stecker-Typ
LY11	50	LZ05F 90° abgewinkelt
SY11	50	SZ05F gerade
XY11	50	XZ05F 102° abgewinkelt

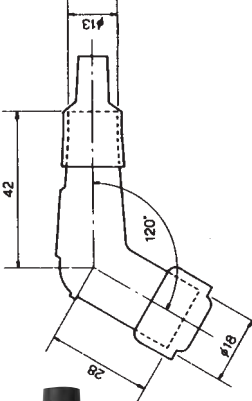

NGK SPARK PLUG RESISTOR COVER

Configuration (applicable plug thread dia, body material) Unit: mm	Type No.	
 <div data-bbox="654 1000 782 1169" style="border: 1px solid black; padding: 5px; width: fit-content; margin-left: auto; margin-right: auto;"> LB-type: 14 mm ø thread LZ-type: 10, 12 & 14 mm ø thread Phenolic resin </div>	<p> LBE LBEPK LB○E LB○EP LB○EPK LB○FF </p>	<p> No resistor No resistor 1,5,10 1,5 5 1,5,10 </p>
	<p> LB○E </p>	<p> 5,10 </p>



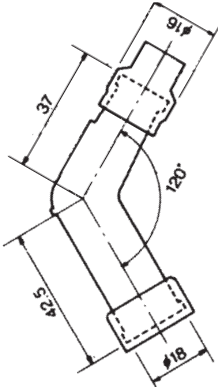

NGK SPARK PLUG RESISTOR COVER

<p>Configuration (applicable plug thread dia, body material) Unit: mm</p>	<p>Type No.</p>	 (kΩ)
<div style="display: flex; align-items: center;">  <div style="margin-left: 20px;"> <p>YB-type: 14 mm ø thread</p> <p>YD-type: 10 & 12 mm ø thread</p> <p>Phenolic resin</p> </div> </div> <div style="display: flex; justify-content: space-around; margin-top: 20px;">    </div>	<p>YB○F YD○F</p> <p>YB○F</p> <p>YD○F</p>	<p>1,5,10 1,5</p> <p>5</p> <p>5</p>





NGK SPARK PLUG RESISTOR COVER

Configuration (applicable plug thread dia, body material) Unit: mm	Type No.	 (k Ω)
 <div data-bbox="760 944 872 1092" style="border: 1px solid black; padding: 5px; width: fit-content;"> VB-type: 14 mm ϕ thread VD-type: 10 & 12 ϕ thread Phenolic resin </div> 	VB○E VB○F VB○FP VD○F	5,1 1,5,10 5 1,5,10
	VB○F	5
	VD○F	5
	VB○F	5
	VD○F	5
	VD○F	5

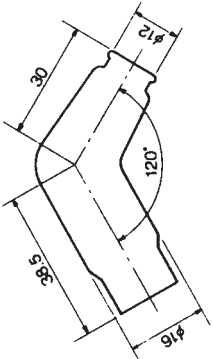

NGK SPARK PLUG RESISTOR COVER

Configuration (applicable plug thread dia, body material) Unit: mm	Type No.	 No resistor No resistor
 [10, 12 & 14 mm ø thread Phenolic resin]	LZEH LZFH	
 [10 mm ø thread CM-6 only Phenolic resin]	LC0EFK	5
 [10 & 12 mm ø thread Rubber sheathed]	SD0FM	5





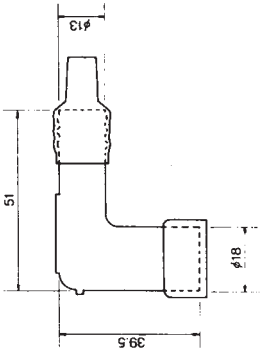

NGK SPARK PLUG RESISTOR COVER

<p>Configuration (applicable plug thread dia, body material) Unit: mm</p>	<p>Type No.</p> <p>VDOFMH</p>	 <p>5</p>
  <p>[10 & 12 mm ø thread Rubber sheathed]</p>	<p>SD05FMC</p> <p>5</p>	
	 	

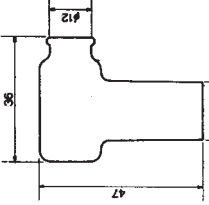

NGK SPARK PLUG RESISTOR COVER

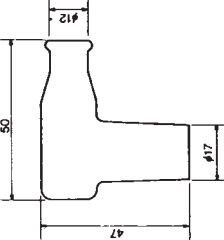
Configuration (applicable plug thread dia, body material) Unit: mm	Type No.	
<div style="display: flex; justify-content: space-around; align-items: center;">   </div> <div style="text-align: right; margin-top: 20px;"> [10 & 12 mm ϕ thread Phenolic resin] </div>	<p>LDF LDOF</p> <p style="text-align: center;">LDOF</p>	<p>No resistor 1,5,10</p> <p style="text-align: center;">5</p>

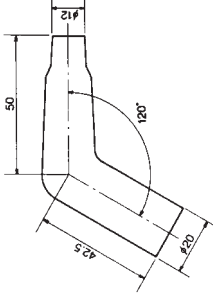

NGK SPARK PLUG RESISTOR COVER

Configuration (applicable plug thread dia, body material) Unit: mm	Type No.	 (kΩ)
 <p data-bbox="317 916 367 1064">[14 mm ø thread Rubber sheathed]</p> 	LB0EMH	5
 <p data-bbox="569 916 636 1064">[14 mm ø thread Rubber sheathed (Silicon)]</p> 	TB0EM	5
 <p data-bbox="819 889 880 1064">[10 & 12 mm ø thread Rubber sheathed (Silicon)]</p> 	VD0FML	5

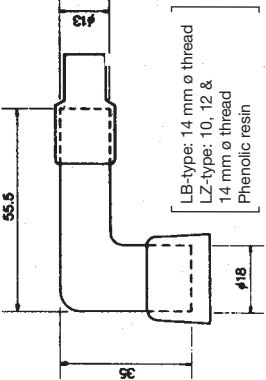



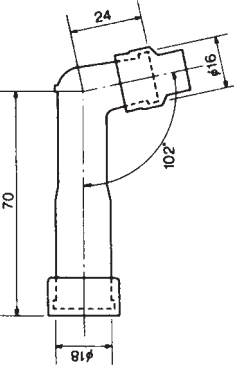



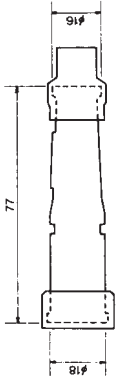

NGK SPARK PLUG RESISTOR COVER

Configuration (applicable plug thread dia, body material) Unit: mm	Type No.	
 	LBF LB○F LB○FP LB○EZ LB○F	No resistor 1,5,10 1,5,10 5 5,10
	LZ○F	5







NGK SPARK PLUG RESISTOR COVER

Configuration (applicable plug thread dia, body material) Unit: mm	Type No.	 (kΩ)
	XB○F	5
<div style="border: 1px solid black; padding: 5px; width: fit-content;"> XB-type: 14 mm ø thread XD-type: 10 & 12 mm ø thread XZ-type: 10, 12 & 14 mm ø thread Phenolic resin </div>	XB○F XB○FP XD○F XZ○F	1,5,10 5 1,5,10 1
	XD○F	1,5,

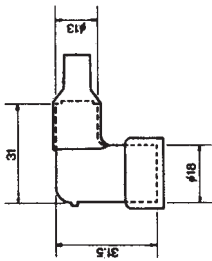

NGK SPARK PLUG RESISTOR COVER

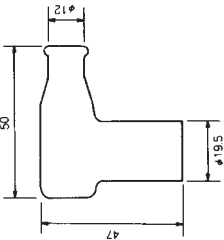
Configuration (applicable plug thread dia, body material) Unit: mm	Type No.	 (kΩ)
    <p data-bbox="500 602 601 777"> [SB-type: 14 mm ϕ thread SD-type: 10 & 12 mm ϕ thread Phenolic resin] </p>	SB  SB  SD 	1,5,10 1,5,10 1,5,10
	SB 	5,10
	SD 	5

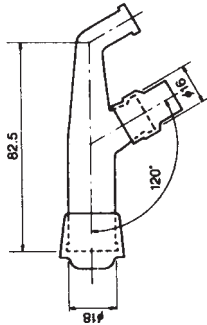

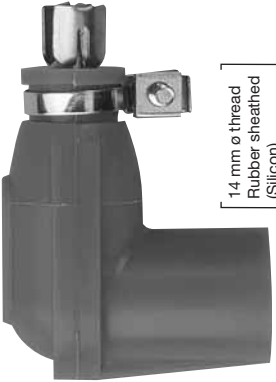
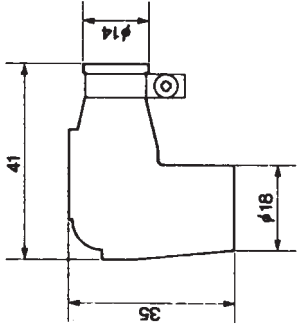

NGK SPARK PLUG RESISTOR COVER

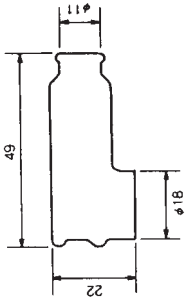
Configuration (applicable plug thread dia, body material) Unit: mm	Type No.	 (kΩ)
  <div style="border: 1px solid black; padding: 5px; width: fit-content; margin-left: 100px;"> LB-type: 14 mm ϕ thread LD-type: 10 & 12 mm ϕ thread Phenolic resin </div>	LEH LB\bigcircEH LB\bigcircEHF LDFH	No resistor 1,5,10 1,5 No resistor
  <div style="border: 1px solid black; padding: 5px; width: fit-content; margin-left: 100px;"> 14 mm ϕ thread Rubber sheathed </div>	TB\bigcircEMA	5
  <div style="border: 1px solid black; padding: 5px; width: fit-content; margin-left: 100px;"> 14 mm ϕ thread Phenolic resin </div>	VB\bigcircEYK	5



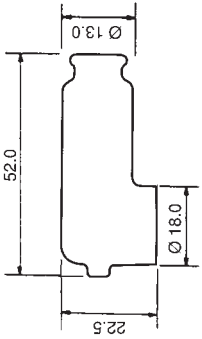

NGK SPARK PLUG RESISTOR COVER

Configuration (applicable plug thread dia, body material) Unit: mm	Type No.	 No resistor
 <p>14 mm ø thread Rubber sheathed (Silicon)</p> 	LBER	
 <p>(Blau)</p>  <p>14 mm ø thread Silicon – Rubber sheathed For spark plug R6120-○, R6120A-○, R6120C-○, R6120M-○ R7282-○, R7282A-○, R7282C-○, R7282M-○ ø 8 mm Kabel</p>	TRS1225	5





NGK SPARK PLUG RESISTOR COVER

Configuration (applicable plug thread dia, body material) Unit: mm	Type No.	 (kΩ)	
<div style="display: flex; justify-content: space-around; align-items: center;"> <div style="text-align: center;">  <p>(Gelb)</p> </div> <div style="text-align: center;">  <p>(Grün)</p> </div> <div style="text-align: center;">  <p>(Rot)</p> </div> </div> <div style="text-align: center; margin-top: 20px;">  </div> <div style="margin-top: 20px;"> <table border="1" style="width: 100%; border-collapse: collapse;"> <tr> <td style="padding: 5px;"> 1.4 mm ø thread Silicon – Rubber sheathed For spark plug R6120-○, R6120A-○ R6120C-○, R6120M-○ R7282-○, R7282A-○ R7282C-○, R7282M-○ ø 7 mm Kabel </td> </tr> </table> </div>	1.4 mm ø thread Silicon – Rubber sheathed For spark plug R6120-○, R6120A-○ R6120C-○, R6120M-○ R7282-○, R7282A-○ R7282C-○, R7282M-○ ø 7 mm Kabel	<p> TRS1233 A TRS1233 B TRS1233 C </p>	<p> 5 5 5 </p>
1.4 mm ø thread Silicon – Rubber sheathed For spark plug R6120-○, R6120A-○ R6120C-○, R6120M-○ R7282-○, R7282A-○ R7282C-○, R7282M-○ ø 7 mm Kabel			

NGK SPARK PLUG RESISTOR COVER

Configuration (applicable plug thread dia, body material) Unit: mm	Type No.	 (kΩ)
 <p>(Blau)</p> <p>14 mm ø thread Silicon – rubber sheathed For spark plug R5300A-○, R5300N-○ ø 8 mm Kabel</p>	<p>TRS1408F</p>	<p>5</p>
 <p>(Rot)</p> <p>14 mm ø thread Rubber sheathed Silicon For spark plug R5540F-○ ø 7 mm Kabel</p>	<p>TRS1409</p>	<p>5</p>
 <p>(Blau)</p> <p>14 mm ø thread Silicon – rubber sheathed For spark plug R6120-○, R6120A-○, R6120C-○, R6120M-○ R7282-○, R7282A-○, R7282C-○, R7282M-○ ø 7 mm Kabel</p>	<p>TRS1505</p>	<p>5</p>

NGK SPARK PLUG RESISTOR COVER

Configuration (applicable plug thread dia, body material) Unit: mm	Type No.	 (kΩ)
 <p data-bbox="310 1122 391 1268"> [10, 12 & 14 mm ø thread Silicon - Rubber sheathed] </p> <p data-bbox="295 669 310 786">108(CR1),115(CR3)</p> <p data-bbox="363 949 378 968">Φ19</p>	<p data-bbox="214 422 236 487">CR1</p> <p data-bbox="263 422 285 487">CR3</p>	<p data-bbox="221 268 236 288">5</p> <p data-bbox="270 268 285 288">5</p>
 <p data-bbox="572 940 653 1086"> [10, 12 & 14 mm ø thread Silicon - Rubber sheathed] </p> <p data-bbox="449 613 480 688">58(CR2,CR5) 49(CR4,CR6)</p> <p data-bbox="523 744 555 781">49(CR2,CR5) 46(CR4,CR6)</p> <p data-bbox="629 660 644 680">ø19.5</p>	<p data-bbox="459 422 480 487">CR2</p> <p data-bbox="502 422 523 487">CR4</p> <p data-bbox="544 422 566 487">CR5</p> <p data-bbox="587 422 608 487">CR6</p>	<p data-bbox="463 268 478 288">5</p> <p data-bbox="506 268 521 288">5</p> <p data-bbox="549 268 563 288">5</p> <p data-bbox="591 268 606 288">5</p>
<p data-bbox="704 1086 725 1282">Kabelverbinder</p> 	<p data-bbox="704 436 725 487">J-1</p>	

Erklärung der Kurzzeichen

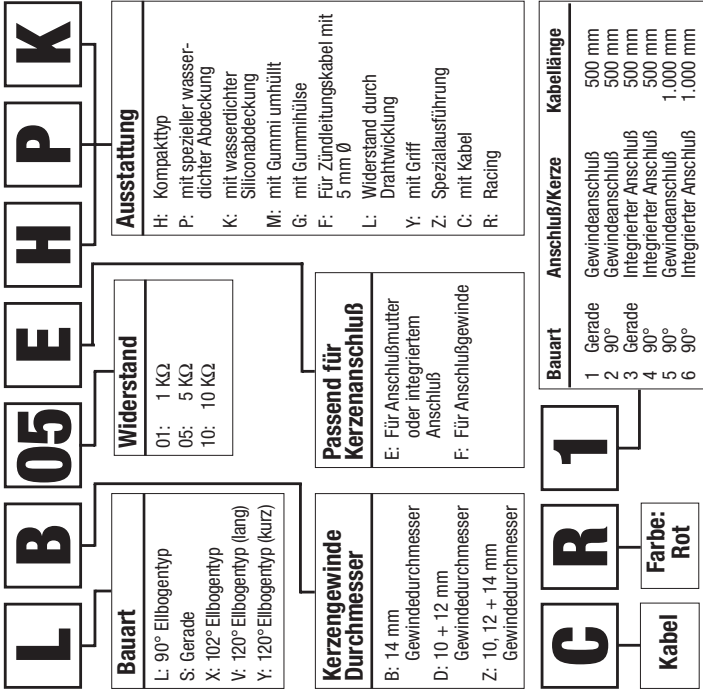

* TRS ... Stecker nur für Rennbetrieb

SYMBOL EXPLANATION

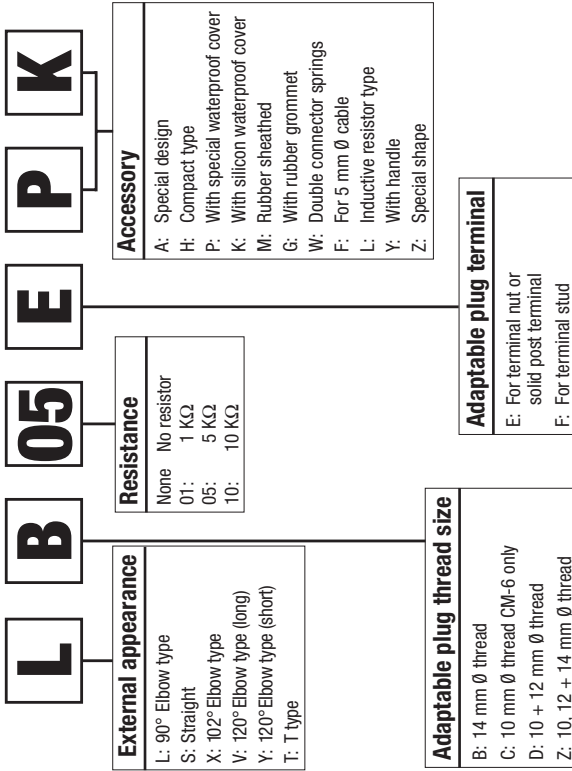

Markierungszeichen auf NGK Zündkerzen

Die Standard-Typenaufschrift ist hier aufgeführt. Es gibt außerdem noch einige besondere Bezeichnungen.

	Gewinde- durchmesser	Standard- sechskant- schlüsselweite	Struktur u.a.	Wärmewert	Gewindelänge
A	18 mm	25,4 mm	L Bartankerze	2	E 19,0 mm
B	14 mm	20,8 mm	M Kompakttyp	4	H 12,7 mm
C	10 mm	16,0 mm	P Vorgezogene Isolatorspitze	5	L 11,2 mm
D	12 mm	18,0 mm	R Entstörwiderstandstyp	6	EH Gewinde halb ausgeführt
E	8 mm	13,0 mm	U Gleitfunkenstrecke	7	
G	PF 1/2	23,8 mm	Z Zusatzfunkenstrecke	8	
J	12 mm	18,0 mm		(85)	
AB	18 mm	20,8 mm		9	F Typen mit Kegeleditsitz
BC	14 mm	16,0 mm		(95)	A-F Typ 10,9 mm
BK	14 mm	16,0 mm		10	B-F Typ 11,2 mm
	(Iso-Version der) BCP-Baureihe			(105)	B-EF Typ 17,5 mm
DC	12 mm	16,0 mm		11	
				12	
				13	



Elektroden-Abstand (mm)

Keine : Standard

P F R 6 A - 11 A

Konstruktionsmerkmale	
C	Schräge Elektrode
F	Typen mit Kegeldichtszit
G	Renkerze (Nickel-Mittlelektrode)
GV	Gold-Palladium Mittlelektrode (Spezial)
J	2-Masseelektroden (Spezialform)
K	2-Masseelektroden
M	2-Masseelektroden (Mazda), Isolatorlänge = 18,5 mm
T	3-Masseelektroden
Q	4-Masseelektroden
P	Platinelektrode
S	Standardtyp
U	Halbgleitfunken typ
V	Gold-Palladium (Mittlelektrode)
VX	Platin (Mittlelektrode)
W	Wolfraamelektrode
X	Vergrößerter Elektrodenabstand
Y	V-Mittlelektrode mit Keilnut
A, B, D, E, Z	Spezial Konstruktion
-L	Halber Wärmewert, Beispiel: DR8ESL = DR7,5ES
-LM	Isolatorlänge = 14,5 mm
-N	Spezielle Masseelektrode
IX	Iridium

Zündkerzentyp	
I	Iridiumelektrode
P	Platinelektroden
L	Gewindelänge 26,5 mm
Z	Vorgezogene
PL	Funkenlänge
	Platinelektroden und
PZ	Gewindelänge 26,5 mm
	Platinelektroden und
	vergrößerter Elektroden- abstand
IZ	Iridiumelektroden und vergrößerter Elektroden- abstand

Konstruktion	
R	Entstör- widerstands- typ

Bauweise	
A	Ohne Dichtung
B	Spezial
C	Spezial
D	Spezial

Konstruktion	
A	Spezial
B	Spezial
C	Spezial
D	Spezial

Kerzen Körperabmessungen	
F	14 ø x 19 mm, 16 mm
G	14 ø x 19 mm, 20,8 mm
J	12 ø x 19 mm, 18,0 mm
K	12 ø x 19 mm, 16,0 mm
M	10 ø x 19 mm, 16,0 mm
T	Kegeldichtszit 14 ø x 17,5 mm, 16 mm (PTRSA: 14 ø x 25 mm, 16 mm)

Design symbols used in NGK spark plugs

* Standard regulation is drawn here. There also exist a few extraordinary symbols.

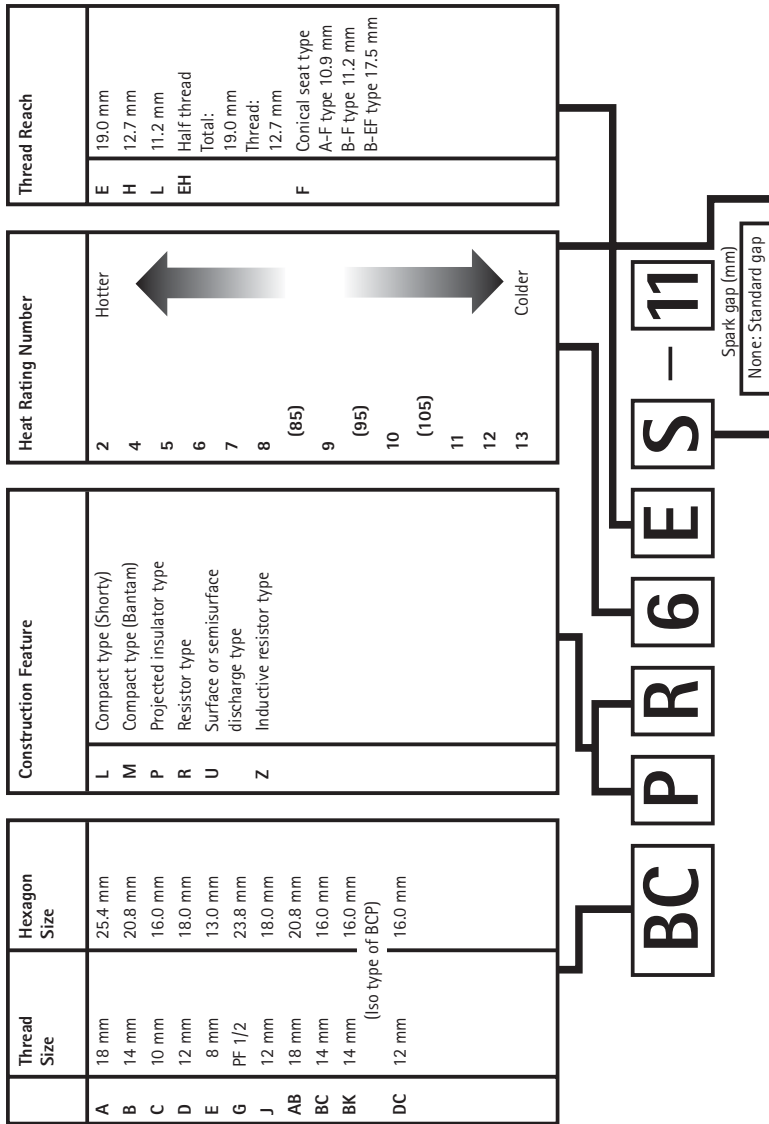

Spark gap (mm)
None: Standard gap

P F R 6 A - 11 A

Firing End Construction, etc.	
C	Low angle ground electrode
F	Conical seat
G	Fine nickel alloy center electrode
GV	Gold-palladium center electrode and special construction
J	Extended 2-Ground electrodes
K	2-Ground electrodes
M	2-Ground electrodes for Mazda rotary eng. or Insulator length: 18.5 mm
T	3-Ground electrodes
Q	4-Ground electrodes
P	Platinum electrode
S	Copper core center electrode
U	Semisurface discharge type
V	Gold-palladium center electrode
VX	Platinum center electrode & special ground electrode
W	Thungsten electrode
X	Booster gap
Y	V-Grooved center electrode
A, B, D, E, Z	Special design
-L	Half heat range
-LM	Compact type (insulator length: 14.5 mm)
-N	Special ground electrode
IX	Iridium

Plug Type	
I	Iridium electrode
P	Platinum electrodes
L	Thread reach 26.5 mm
Z	Extended gap
PL	Platinum electrodes and Thread reach 26.5 mm
PZ	Platinum electrodes and extended gap
IZ	Iridium electrodes and extended gap

Construction	
R	Resistor

Feature	
A	No gasket type
B	Special
C	Special
D	Special

Construction	
A	Special design
B	Special design
C	Special design
D	Special design

Metal Shell Size	
F	14 ø x 19 mm, 16.0 mm Hex.
G	14 ø x 19 mm, 20.8 mm Hex.
J	12 ø x 19 mm, 18.0 mm Hex.
K	12 ø x 19 mm, 16.0 mm Hex.
M	10 ø x 19 mm, 16.0 mm Hex.
T	Conical seat type 14 ø x 17.5 mm, 16.0 mm Hex (PTRSA: 14 ø x 25 mm, 16.0 mm Hex.)

Symboles utilisés pour les Bougies d'Allumage NGK

* Les symboles standards sont expliqués ci-dessous. Il existe également quelques symboles exceptionnellement utilisés.

Diamètre flottage		CLÉ	Dessin de la bougie		Indice thermique		Longueur de filetage	
A	18 mm	25.4 mm	L	Isolant court (shorty)	2	Chaud	E	19.0 mm
B	14 mm	20.8 mm	M	Type compact (Bantam)	4		H	12.7 mm
C	10 mm	16.0 mm	P	isolant proéminent	5		L	11.2 mm
D	12 mm	18.0 mm	R	Résistance intégrée	6		EH	Semi-filetage
E	8 mm	13.0 mm	U	Décharge superficielle ou semi- superficielle	7			Culot
G	1/2 pouce	23.8 mm	Z	Inductance intégrée	8		F	L = 19.0 mm
J	12 mm	18.0 mm			(85)			Filet L = 12.7 mm
AB	18 mm	20.8 mm			9			siège conique
BC	14 mm	16.0 mm			(95)			A-F type
BK	14 mm	16.0 mm			10			10.9 mm
DC	12 mm	16.0 mm			(105)			B-F type
					11			11.2 mm
				12			B-EF type	
				13			17.5 mm	



Ecartement

mes: écartement standard

P F R 6 A - 11 A

Dessin de l'éclateur	
C	Electrode de massa oblique
F	Siège conique
G	Fine électrode en alliage de nickel
GV	Electrode centrale en Or-Palladium
J	Forme spéciale
K	2 élec. de masse
M	2 électrodes de masse
T	2 électrodes de masse pour moteur rotatif MAZDA ou isolant de 18.5 mm
Q	3 électrodes de masse
P	4 électrodes de masse
S	Pointe platine
U	Electrode centrale en cuivre
V	Type à décharge semi-surfacique
VX	Electrode centrale Or-Palladium
W	Electrode centrale en Platine
X	Electrode tungstène
Y	Eclateur interne
A, B, D, E, Z	Gorge en «V»
-L	Dessin spécial
-LM	Demi-indice thermique
-N	Type compact longueur d'isolant 14.5 mm
IX	Electrode de masse spéciale Iridium

Type	Description
I	Electrode d'iridium
P	Electrodes de platine
L	Filetage de 26.5 mm de long
Z	Intervalle élargi
PL	Electrodes de platine avec filetage de 26.5 mm de long
PZ	Electrodes de platine à intervalle élargi
IZ	Electrodes d'iridium à intervalle élargi

Typ de construction	
R	Résistance

caractéristique particulière	
A	Bougie à siège conique
B	spécial
C	spécial
D	spécial

Familles de Conception	
A	Dessin spécial
B	Dessin spécial
C	Dessin spécial
D	Dessin spécial

Dimension du culot	
F	Filetage ø x L CLÉ
G	14 ø x 19 mm, 16.0 mm
J	14 ø x 19 mm, 20.8 mm
K	12 ø x 19 mm, 18.0 mm
M	12 ø x 19 mm, 16.0 mm
T	10 ø x 19 mm, 16.0 mm
	Siège conique 14 ø x 17.5 mm, 16.0 mm (PTR5A: 14 ø x 25 mm, 16.0 mm)

SYMBOOL VERKLARING

* standaard uitvoering. Uitzonderingen bestaan.

Diameter	Sleutelwijdte zeskant	Uitvoering	Warmtewaarde nummer	Draadlengte
A	25.4 mm	L Mini	2 Varm	E 19,0 mm
B	20.8 mm	M Compact type	4	H 12,7 mm
C	16.0 mm	P Verlengde elektrode	5	L 11,2 mm
D	18.0 mm	R Ontstoord	6	EH half draad
E	13.0 mm	U Glijvonk of extra elektronenafstand	7	Totaal : 19,0 mm
G	23.8 mm	Z Inductie weerstand type	8	Draad : 12,7 mm
J	18.0 mm		9 (85)	conische zitting
AB	20.8 mm		10 (105)	A-F 10,9 mm
BC	16.0 mm		11	B-F 11,2 mm
BK	14 mm		12	B-EF 17,5 mm
DC	16.0 mm		13 Kouder	



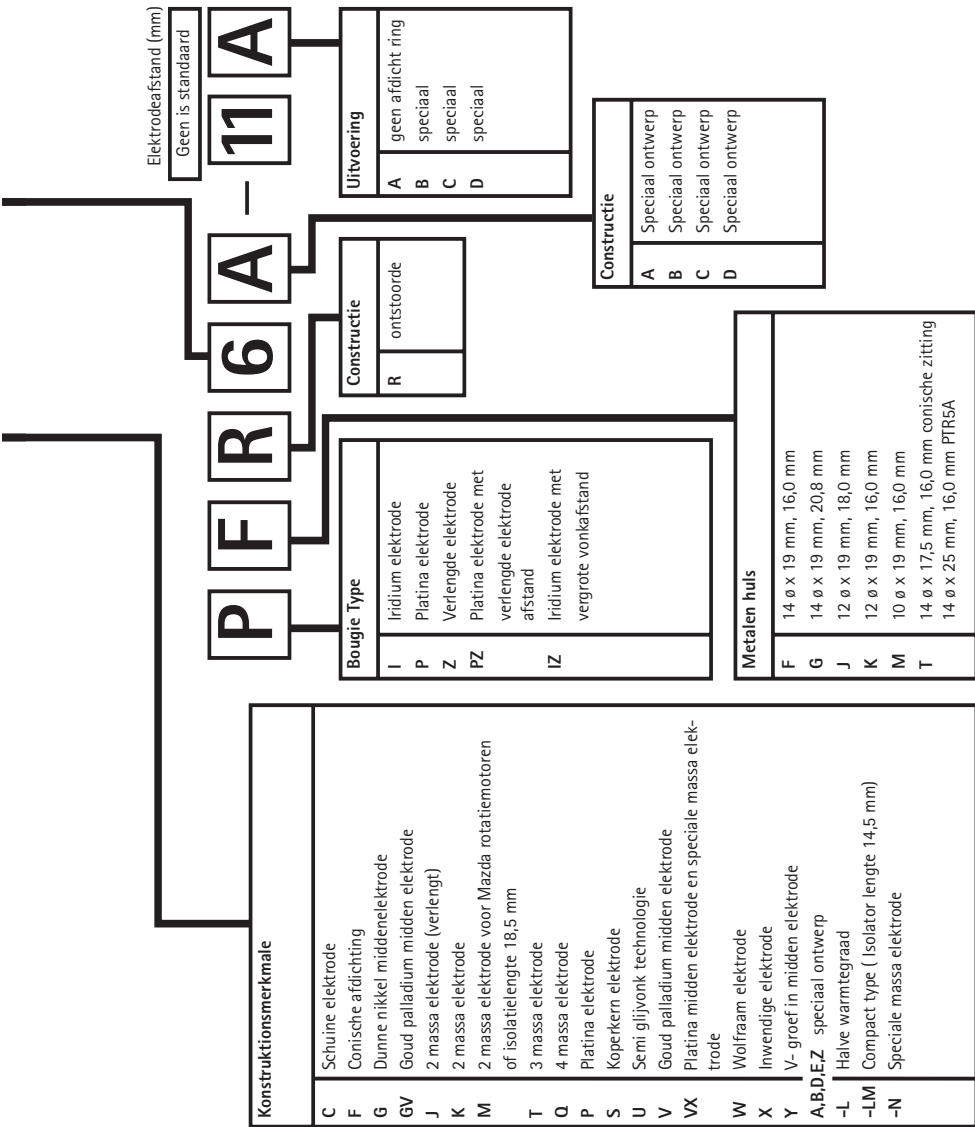

Referencias utilizadas en las bujías NGK

* A continuación se indican los códigos más convencionales (algunas veces puede encontrarse algún código que no siga esta estructura)

	Díámetro de la rosca	Tamaño del Hexágono	Construcción, características	Grado térmico	Longitud de la rosca
A	18 mm	25,4 mm	L Tipo compacto (corto)	2	E 19,0 mm
B	14 mm	20,8 mm	M Tipo compacto (Bantam)	4	H 12,7 mm
C	10 mm	16,0 mm	P Tipo aislador proyectado	5	L 11,2 mm
D	12 mm	18,0 mm	R Tipo resistencia	6	EH Media rosca
E	8 mm	13,0 mm	U Tipo descarga superficial o semi-superficial	7	Total: 19,0 mm
G	PF 1/2	23,8 mm	Z Tipo resistencia inductiva	8	Rosca: 12,7 mm
J	12 mm	18,0 mm		(85)	F Tipo asiento cónico
AB	18 mm	20,8 mm		9	Tipo A-F 10,9 mm
BC	14 mm	16,0 mm		(95)	Tipo B-F 11,2 mm
BK	14 mm	16,0 mm		10	Tipo B-EF 17,5 mm
DC	12 mm	16,0 mm		(105)	
				11	
				12	
				13	



Galga (mm)
Nada: Galga convencional

11A

6A

R

PFR

Características	
A	Tipo sin junta
B	Especial
C	Especial
D	Especial

Construcción	
R	Resistencia

Tipo de bujías	
I	Iridium electrode
P	Electrodos de platino
L	Longitud de la rosca 26.5 mm
Z	Extended gap
PL	Electrodos de platino y longitud de la rosca 26.5 mm
PZ	Electrodos de platino y galga proyectada
IZ	Electrodos de iridio y galga proyectada

Construcción	
A	Diseño especial
B	Diseño especial
C	Diseño especial
D	Diseño especial

Tamaño del casquillo metálico	
F	14 ø x 19 mm, 16,0 mm
G	14 ø x 19 mm, 20,8 mm
J	12 ø x 19 mm, 18,0 mm
K	12 ø x 19 mm, 16,0 mm
M	10 ø x 19 mm, 16,0 mm
T	Tipo asiento cónico 14 ø x 17.5 mm, 16,0 mm (PTRSA: 14 ø x 25 mm, 16,0 mm)

Configuración de la punta del encendido	
C	Electrodo de masa oblicuo
F	Asiento cónico
G	Electrodo central fino en aleación de níquel
GV	Electrodo central en oro-paladio y construcción especial
J	2-Electrodos de masa proyectados
K	2-Electrodos de masa
M	2-Electrodos de masa para motor rotativo Mazda o Aislador = 18.5 mm de largo.
T	3-Electrodos de masa
Q	4-Electrodos de masa
P	Electrodo de platino
S	Electrodo central de cobre
U	Tipo descarga semi-superficial
V	Electrodo central en oro-paladio
VX	Electrodo central en platino, y electrodo de masa especial
W	Electrodo de tungsteno
X	Galga auxiliar en serie
Y	Electrodo central ranurado en V
A, B, D, E, Z	Diseño especial
-L	Grado térmico intermedio
-LM	Tipo compacto (longitud del aislador : 14.5 mm)
-N	Electrodo de masa especial
IX	Iridium

SÍMBOLOS DO DESENHO USADOS EM VELAS DE IGNIÇÃO NGK

* Aqui são desenhadas normas padrões. Também existem alguns símbolos extraordinários.

Tamanho da rosca	Tamanho do hexágono	Característica da Construção	Número de potência térmica	Alcance da rosca
A 18 mm	25.4 mm	L Tipo compacto (Shorty)	2 mais quente	E 19,0 mm
B 14 mm	20.8 mm	M Tipo compacto (Bantam)	4	H 12,7 mm
C 10 mm	16.0 mm	P Tipo isolador projetado	5	L 11,2 mm
D 12 mm	18.0 mm	R Tipo de resistor	6	EH Meia rosca
E 8 mm	13.0 mm	U Tipo de descarga Superficial ou Semi-surface	7	Total: 19,0 mm
G PF 1/2	23.8 mm	Z Tipo de resistor indutivo	8	Rosca: 12,7 mm
J 12 mm	18.0 mm		(85)	Tipo de base cônica
AB 18 mm	20.8 mm		9	Tipo A-F 10,8 mm
BC 14 mm	16.0 mm		(95)	Tipo B-F 11,2 mm
BK 14 mm	16.0 mm		10	Tipo B-EF 17,5 mm
(Tipo de ISO do BCP)	16.0 mm		(105)	
DC 12 mm	16.0 mm		11	
			12	
			13	



Espaço da vela (mm)

Nenhum: Espaço padrão

P F R 6 A - 11 A

Construção da ponta de ignição	
C	Eléctrodo de massa de baixo ângulo
F	Base cônica
G	Eléctrodo central de liga de níquel fino
GV	Eléctrodo central de ouro-paládio e construção especial
J	2 eléctrodos de terra ampliados
K	2 eléctrodos de terra
M	2 eléctrodos de terra para motor rotativo Mazda ou comprimento do isolador: 18,5 mm
T	3 eléctrodos de terra
Q	4 eléctrodos de terra
P	Eléctrodo de platina
S	Eléctrodo central com centro de cobre
U	Tipo de descarga Semi-surface
V	Eléctrodo central de ouro paládio
VX	Eléctrodo central de platina e eléctrodo de terra especial
W	Eléctrodo de tungsténio
X	Espaço intensificador
Y	Eléctrodo central acanalado em V
A,B,D,E,Z	Desenho especial
-L	Metade da escala de calor
-LM	Tipo compacto (comprimento do isolador: 14,5 mm)
-N	Eléctrodo de terra especial
IX	Iridium

Tipo de Vela

I	Eléctrodo de irídio
P	Eléctrodo de platina
Z	Espaço ampliado
PZ	Eléctrodo de platina e espaço ampliado
IZ	Eléctrodo de irídio e espaço ampliado

Construção

R	Resistor
---	----------

Característica

A	Nenhum tipo de gaxeta
B	Especial
C	Especial
D	Especial

Construção

A	Desenho Especial
B	Desenho Especial
C	Desenho Especial
D	Desenho Especial

Tamanho do envoltório de metal

F	14 Ø x 19 mm, Héx 16,0 mm
G	14 Ø x 19 mm, Héx 20,8 mm
J	12 Ø x 19 mm, Héx 18,0 mm
K	12 Ø x 19 mm, Héx 16,0 mm
M	10 Ø x 19 mm, Héx 16,0 mm
T	Tipo de base cônica 14 Ø x 17,5 mm, Héx 16,0 mm (PTRSA: 14 Ø x 25 mm, Héx 16 mm)

DECODIFICA DEI CODICI CANDELE NGK

La seguente tabella indica i principali codici. Sono possibili comunque ulteriori simboli.

	Diametro filettatura	Esagono	Struttura	Grado Termico	Lunghezza filettatura
A	18 mm	25.4 mm	L Tipo compatto	2	E 19,0 mm
B	14 mm	20.8 mm	M Tipo bantam	4	H 12,7 mm
C	10 mm	16.0 mm	P Punta dell'isolatore prominente	5	L 11,2 mm
D	12 mm	18.0 mm	R Tipo resistivo	6	EH Parzialmente filettata
E	8 mm	13.0 mm	U Scarica superficiale o semisuperficiale.	7	Lunghezza totale: 19,0 mm
G	PF 1/2	23.8 mm	Z Resistore induttivo	8	Filettatura : 12,7 mm
J	12 mm	18.0 mm		(85)	
AB	18 mm	20.8 mm		9	F Sede conica
BC	14 mm	16.0 mm		(95)	Tipo A-F 10,9 mm
BK	14 mm	16.0 mm		10	Tipo B-F 11,2 mm
	(versione ISO del tipo BCP)			(105)	Tipo B-EF 17,5 mm
DC	12 mm	16.0 mm		11	
				12	
				13	

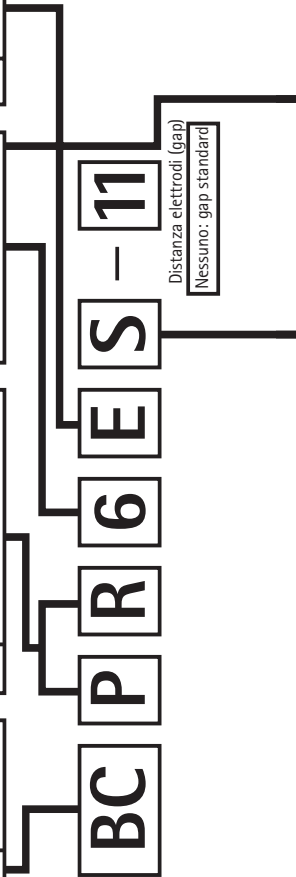

Distanza elettrodi (gap)

Nessuno: gap standard

P F R 6 A - 11 A

Caratteristiche	
C	elettrodo di massa obliquo
F	sede conica
G	elettrodo centrale sottile in nickel
GV	elettrodo centrale in oro-palladio e particolare costruzione
J	2 elettrodi di massa speciali
K	2 elettrodi di massa
M	2 elettrodi di massa per motori rotativi Mazda
T	o lunghezza isolatore 18,5 mm
Q	3 elettrodi di massa
P	4 elettrodi di massa
P	Elettrodo al platino
S	Tipo standard. Elettrodo centrale con anima in rame
U	Tipo a scarica semisuperficiale
V	Elettrodo centrale in oro-palladio
VX	Elettrodo centrale in platino ed elettrodo di massa speciale
W	Elettrodo in tungsteno
X	Salto di scintilla interno
Y	Elettrodo centrale scanalato a "v"
A,B,D,E,Z	Disegno speciale
-L	Metà grado termico
-LM	Tipo compatto (lunghezza isolatore 14,5 mm)
-N	Elettrodo di massa speciale
IX	Iridium

Tipo candela	
I	Elettrodo all' Iridio
P	Elettrodo (I) al platino
L	Lunghezza radice filettata 26,5 mm
Z	gap esteso
PL	Elettrodo al platino e radice filettata 26,5 mm
PZ	Elettrodo in platino e gap esteso
IZ	Elettrodo all' Iridio e distanza elettrodi (gap) speciale

Struttura	
R	Tipo resistivo

Caratteristiche	
A	senza guarnizione speciale
B	speciale
C	speciale
D	speciale

Caratteristiche	
A	Disegno speciale
B	Disegno speciale
C	Disegno speciale
D	Disegno speciale

Dimensioni corpo metallico	
F	14 Ø x 19 mm, Esagono 16,0 mm
G	14 Ø x 19 mm, Esagono 20,8 mm
J	12 Ø x 19 mm, Esagono 18,0 mm
K	12 Ø x 19 mm, Esagono 16,0 mm
M	10 Ø x 19 mm, Esagono 16,0 mm
T	Sede conica 14 Ø x 17,5 mm Esagono 16,0 mm (PTRSA: 14 Ø x 25 mm Esagono 16,0 mm)



MARKERINGSTEGN PÅ NGK TÆNDRØR

* Standardtypepåskriften er anført her.

	Gevind-diameter	Nøgle-størrelse	Struktur	Varmeværdi	Gevindlængde
A	18 mm	25.4 mm	L Bantamrør	2	E 19,0 mm
B	14 mm	20.8 mm	M Kompakt type	4	H 12,7 mm
C	10 mm	16.0 mm	P Fremskudt isolator	5	L 11,2 mm
D	12 mm	18.0 mm	R Radiostøjdæmpet	6	EH Gevind i halv udførsel
E	8 mm	13.0 mm	U Luftglednisteknik	7	I alt: 19,0 mm
G	PF 1/2	23.8 mm	Z Afbrændingsmodstand	8	Gevind: 12,7 mm
J	12 mm	18.0 mm		(85)	Typen med konisk gevind
AB	18 mm	20.8 mm		9	A-F type 10,9 mm
BC	14 mm	16.0 mm		(95)	B-F type 11,2 mm
BK	14 mm	16.0 mm		10	B-EF type 17,5 mm
DC	12 mm	16.0 mm		(105)	
				11	
				12	
				13	



Elektrodeafstand (mm)

Ingen: Standard

11A

6A

6A

6A

6A

6A

6A

Konstruktion	
A	Uden pakning
B	Speciel
C	Speciel
D	Speciel

Konstruktion	
R	Radiostøj- dæmpning- stype

Tændrørstype	
I	Iridium elektrode
P	Platin elektrode
Z	Fremskudt gnistpunkt
PZ	Platin elektrode, frem- skudt gnistpunkt
IZ	Iridium elektrode

Konstruktion	
A	Speciel
B	Speciel
C	Speciel
D	Speciel

Dim. på metalhus	
F	14 Ø x 19 mm, 16,0 mm
G	14 Ø x 19 mm, 20,8 mm
J	12 Ø x 19 mm, 18,0 mm
K	12 Ø x 19 mm, 16,0 mm
M	10 Ø x 19 mm, 16,0 mm
T	Konisk sæde (uden pakning) 14 Ø x 17,5 mm, 16,0 mm (PTRSA: 14 Ø x 25 mm, 16,0 mm)

Speciel konstruktion	
C	Skæv elektrode
F	Konisk gevind (uden pakninger)
G	Racerør (nikkel-midterelektrode)
GV	Guld-Paladium (midterelektrode)
J	2-side elektrode (speciel)
K	2-side elektrode
M	2-side elektroder (Mazda)
T	Isolatorlængde 18,5 mm
Q	3-sideelektroder
O	4-sideelektroder
P	Platinelektrode
S	Standardtype
U	Halvgjidegnisttype
V	Guld-Paladium (midterelektrode)
VX	Platin (midterelektrode)
W	Wolfraamelektrode
X	Forstørret elektrodeafstand
Y	V-midterelektrode
A, B, D, E, Z	Speciel konstruktion
-L	Halv varmeværdi
-LM	Isolatorlængde 14,5 mm
-N	Speciel sideelektrode
IX	Iridium

TEKNISKE SYMBOLER BRUKT I NGK TENNPLUGGER

* Standardregulering er vist her. Det finnes også noen spesielle symboler.

Gjengestørrelse		Sekskantstørrelse	
A	18 mm	25.4 mm	Konstruksjonsgenskaper L Kompakt type (Shorry) M Kompakt type (Bantam) P Frenspringende isolatortype R Motstandstype U Surface- eller Semi-Surface-utladningstype Z Induktiv motstandstype
B	14 mm	20.8 mm	
C	10 mm	16.0 mm	
D	12 mm	18.0 mm	
E	8 mm	13.0 mm	
G	PF 1/2	23.8 mm	
J	12 mm	18.0 mm	
AB	18 mm	20.8 mm	
BC	14 mm	16.0 mm	
BK	14 mm	16.0 mm	
		(ISO-type av BCP)	
DC	12 mm	16.0 mm	



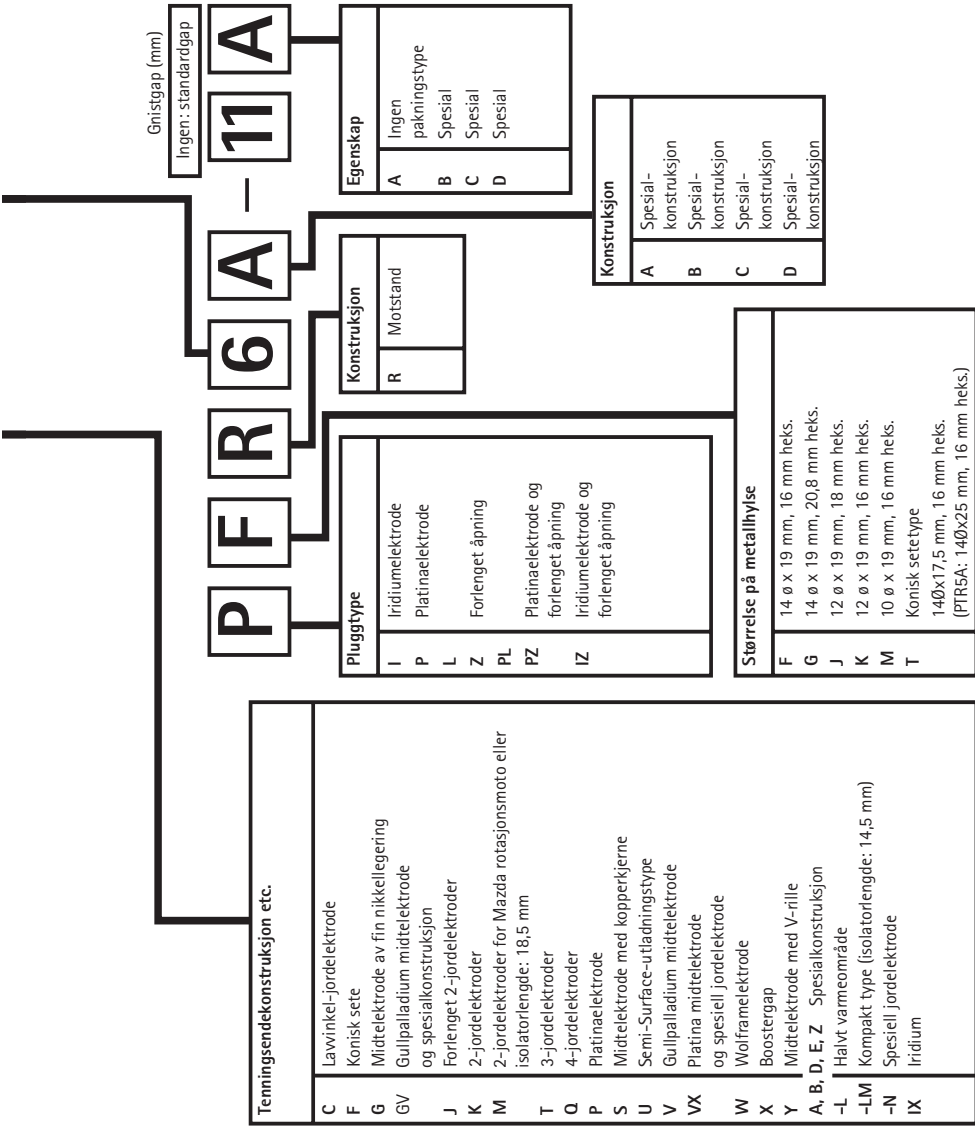

Gnistgap (mm)

Ingen: standardgap

P F R 6 A 11 A

Egenskap	
A	Ingen pakningstype
B	Spesial
C	Spesial
D	Spesial

Konstruksjon	
R	Motstand

Pluggtype	
I	Iridiumelektrode
P	Platinaelektrode
L	Forlengt 2-jordelektrode
Z	Forlengt 4-jordelektrode
PL	Platinaelektrode og forlengt 2-jordelektrode
PZ	Platinaelektrode og forlengt 4-jordelektrode
IZ	Iridiumelektrode og forlengt 2-jordelektrode

Konstruksjon	
A	Spesial-konstruksjon
B	Spesial-konstruksjon
C	Spesial-konstruksjon
D	Spesial-konstruksjon

Størrelse på metallhylse	
F	14 ø x 19 mm, 16 mm heks.
G	14 ø x 19 mm, 20,8 mm heks.
J	12 ø x 19 mm, 18 mm heks.
K	12 ø x 19 mm, 16 mm heks.
M	10 ø x 19 mm, 16 mm heks.
T	Konisk setetype 140x17,5 mm, 16 mm heks. (PTRSA: 140x25 mm, 16 mm heks.)

Tenningsendekonstruksjon etc.	
C	Lawinkel-jordelektrode
F	Konisk sete
G	Midtelektrode av fin nikkellegering
GV	Gullpalladium midtelektrode og spesialkonstruksjon
J	Forlengt 2-jordelektrode
K	2-jordelektrode
M	2-jordelektroder for Mazda rotasjonsmoto eller isolatorlengde: 18,5 mm
T	3-jordelektrode
Q	4-jordelektrode
P	Platinaelektrode
S	Midtelektrode med koppekjerne
U	Semi-Surface-utladningstype
V	Gullpalladium midtelektrode
VX	Platina midtelektrode og spesiell jordelektrode
W	Wolfraamelektrode
X	Booster-gap
Y	Midtelektrode med V-rille
A, B, D, E, Z	Spesialkonstruksjon
-L	Halvt varmeområde
-LM	Kompakt type (isolatorlengde: 14,5 mm)
-N	Spesial jordelektrode
IX	Iridium

NGK-SYTYTYSTULPPIEN TYYPPIMERKINNÄT

* Tässä on esitetty normaalisäädot. Näiden lisäksi on erikoismerkintöjä.

Kierteen koko	Kuusikulmion koko	Rakenneominaisuus	Lämpöarvo	Kierteen pituus
A	18 mm	L Kompakti (Shorty)	2	E 19,0 mm
B	14 mm	M Kompakti (Bantam)	4	H 12,7 mm
C	10 mm	P Ulkoneva eriste	5	L 11,2 mm
D	12 mm	R Resistori	6	EH Puolikerre
E	8 mm	U Pinta- tai puolipintapurkaus	7	Kokonaispituus: 19,0 mm
G	PF 1/2	Z Induktiivinen resistori	8	Kierre: 12,7 mm
J	12 mm		(85)	Karttomainen
AB	18 mm		9	Tyyppi A-F
BC	14 mm		(95)	10,9 mm
BK	14 mm		10	Tyyppi B-F
	(BCP:n ISO-tyyppi)		(105)	11,2 mm
DC	12 mm		11	Tyyppi B-EF
			12	17,5 mm
			13	



Kärkiväli (mm)
Ei mitään: Normaali kärkiväli

P F R 6 A - 11 A

Ominaisuus	
A	Ei tiivistettä
B	Erikois
C	Erikois
D	Erikois

Rakenne	
R	Resistori

Tulpan tyyppi	
I	Iridiumkärki
P	Platinakärki
Z	Pidennetty kärkiväli
PZ	Platinakärki, pidennetty kärkiväli
IZ	Iridiumkärki, pidennetty kärkiväli

Rakenne	
A	Erikoisrakenne
B	Erikoisrakenne
C	Erikoisrakenne
D	Erikoisrakenne

Metallivaipan koko	
F	14 Ø x 19 mm, 16,0 mm (kuusikulmio)
G	14 Ø x 19 mm, 20,8 mm (kuusikulmio)
J	12 Ø x 19 mm, 18,0 mm (kuusikulmio)
K	12 Ø x 19 mm, 16,0 mm (kuusikulmio)
M	10 Ø x 19 mm, 16,0 mm (kuusikulmio)
T	Kartoistukka 14 Ø x 17,5 mm, 16,0 mm (kuusikulmio) (PTR5A: 14 Ø x 25 mm, 16,0 mm (kuusikulmio))

Sytystypän rakenne	
C	Pienikulmainen sivukärki
F	Kartoistukka
G	Ohut nikkeliseoksinen keskikärki
GV	Keskikärki kulta-palladiumia, erikoisrakenne
J	2 pidennettyä sivukärkeä
K	2 sivukärkeä
M	2 sivukärkeä pyöriväsiinteriselle Mazda-mootorille tai eristimen pituudelle 18,5 mm
T	3 sivukärkeä
Q	4 sivukärkeä
P	Platinakärki
S	Kuparisydäminen keskikärki
U	Puolipintapurkaus
V	Keskikärki kulta-palladiumia
VX	Platinainen keskikärki ja erikoissivukärki
W	Volframikärki
X	Tehostinkärki
Y	V-urallinen keskikärki
A,B,D,E,Z	Erikoisrakenne
-L	Puolitettu lämpöarvoalue
-LM	Kompakti (eristeen pituus: 14,5 mm)
-N	Erikoissivukärki
IX	Iridium

NGK SÜÜTEKÜÜNLA SÜMBOLITE SELGITUSED

Keerme läbimõõt	Kuuskant	Ehitus	Hõõgarv Soojusväärtus	Keerme pikkus
A	25.4 mm	L	2	E 19.0 mm
B	20.8 mm	M	4	H 12.7 mm
C	16.0 mm	P	5	L 11.2 mm
D	18.0 mm	R	6	EH Keere ainult pooleni
E	13.0 mm	U	7	Kogupikkus: 19.0 mm
G	23.8 mm	Z	8	Keere: 12.7 mm
J	18.0 mm		(85)	Koonustihendi tüüp
AB	18 mm		(95)	A-F tüüp
BC	14 mm		10	10.9 mm
BK	14 mm		(105)	B-F tüüp
DC	12 mm		11	11.2 mm
			12	B-EF tüüp
			13	17.5 mm



Sädevahe (mm)

Paarub-standardne sädevahe

P F R 6 A - 11 A

Konstruktsiooni tüübid	
C	kaldelektrood
F	koostühend
G	Võidusõiduks (mikkel keskelektrood)
GV	Kuld-pallaadium keskelektrood
J	2 külgelektroodi (erikuju/lised)
K	2 külgelektroodi
M	2 külgelektroodi: isolaatori pikkusega: 18,5 mm
T	3 külgelektroodi
Q	4 külgelektroodi
P	Plaattina elektrood
S	Standardtüüp
U	Lisäsädevahega
V	Kuld-pallaadium keskelektrood
VX	Plaattina keskelektrood/Spets külgelektrood
W	Võlfram elektrood
X	Suurendatud sädevahe
Y	V-soonega keskelektrood
A, B, D, E, Z	erikonstruktsioon
-L	Poolhõõgaruga
-LM	Kompakt tüüpisolaator: 14,5 mm
-N	Erihitusega keskelektrood
IX	Iridium

Küümitüüp	
I	iridium elektrood
P	plaattina elektrood
Z	suurendatud sädevahega
PZ	plaattina elektr. Et
IZ	suurendatud sädevahe iridium elektr. Et
	suurendatud sädevahe

Konstruktsioon	
R	Taliksi

Toote tüüp	
A	Tihendita tüüp
B	Spetsiaalehitusega
C	Spetsiaalehitusega
D	Spetsiaalehitusega

Ehituse tüüp	
A	Spetsiaalehitus
B	Spetsiaalehitus
C	Spetsiaalehitus
D	Spetsiaalehitus

Korpuse mõõdud	
F	14 ø x 19 mm, 16,0 mm kuuskant
G	14 ø x 19 mm, 20,8 mm kuuskant
J	12 ø x 19 mm, 18,0 mm kuuskant
K	12 ø x 19 mm, 16,0 mm kuuskant
M	10 ø x 19 mm, 16,0 mm kuuskant
T	Koonustihend 14 ø x 17,5 mm, 16,0 mm kuuskant (PTRSA: 14 ø x 25 mm, 16,0 mm kuuskant)

ZNAČENÍ POUŽÍVANÉ U ZAPALOVACÍCH SVÍČEK NGK

* Na obrázku je uvedeno standardní značení. Existuje ještě několik speciálních symbolů.

Velikost závitů	Velikost šestihranu	Konstrukční typ	Teplotní označení	Dosah závitů
A	25,4 mm	L Kompaktní (Shorty)	2 vysoká teplota	E 19,0 mm
B	20,8 mm	M Kompaktní (Bantam)	4	H 12,7 mm
C	18,0 mm	P Typ s předseznamným izolátorem	5	L 11,2 mm
D	18,0 mm	R Odporový typ	6	EH Polozávit
E	13,0 mm	U Typ s povrchovým nebo polopovrchovým výbojem	7	Celkem: 19,0 mm
G	23,8 mm	Z Indukční odporový typ	8	Závit: 12,7 mm
J	18,0 mm		(85)	Typ s konickým usazením
AB	20,8 mm		9	Typ A-F
BC	16,0 mm		(95)	10,9 mm
BK	16,0 mm		10	Typ B-F
DC	12 mm (ISO typ BCP)		(105)	11,2 mm
			11	Typ B-EF
			12	17,5 mm
			13	

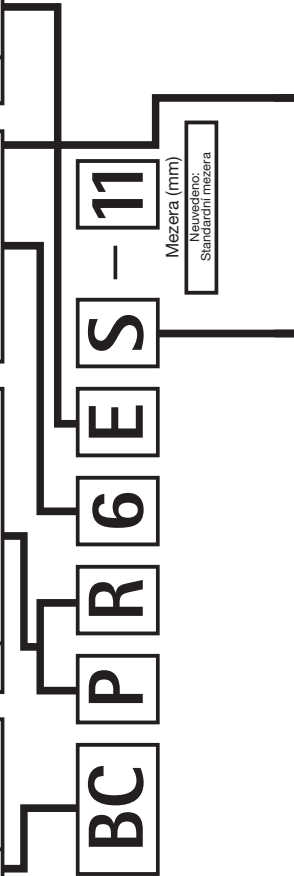

Mezera (mm)
 Neuváděno:
 Standardní mezera

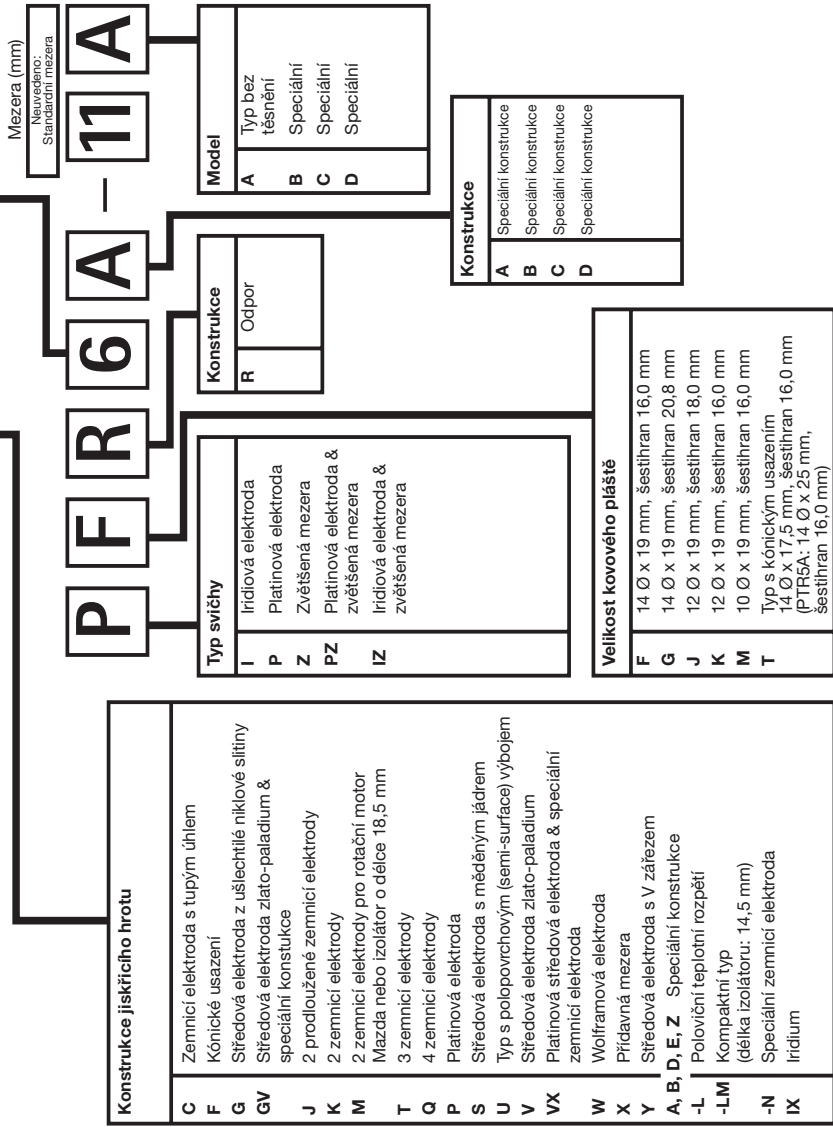

Mezera (mm)
Nevýběrné
Standardní mezera

11A

6A

R

P

Model	
A	Typ bez těsnění
B	Speciální
C	Speciální
D	Speciální

Konstrukce	
R	Odpor

Typ svíčky	
I	Iridiová elektroda
P	Platinová elektroda
Z	Zvětšená mezera
PZ	Platinová elektroda & zvětšená mezera
IZ	Iridiová elektroda & zvětšená mezera

Konstrukce	
A	Speciální konstrukce
B	Speciální konstrukce
C	Speciální konstrukce
D	Speciální konstrukce

Konstrukce jiskřičho hrotu	
C	Zemnicí elektroda s tupým uhlím
F	Kónické usazení
G	Sřídová elektroda z ušlechtilé niklové slitiny
GV	Sřídová elektroda z zlato-paladium & speciální konstrukce
J	2 prodloužené zemnicí elektrody
K	2 zemnicí elektrody
M	2 zemnicí elektrody pro rotační motor
T	Mazda nebo izolátor o délce 18,5 mm
Q	3 zemnicí elektrody
P	4 zemnicí elektrody
S	Platinová elektroda
U	Sřídová elektroda s měděným jádrem
V	Typ s polopovrchovým (semi-surface) výbojem
VX	Sřídová elektroda z zlato-paladium
W	Platinová sřídová elektroda & speciální zemnicí elektroda
X	Wolframová elektroda
Y	Přídavná mezera
A, B, D, E, Z	Sřídová elektroda s V zářezem
-L	Speciální konstrukce
-LM	Poloviční teplotní rozpětí
-L	Kompaktní typ
-N	(délka izolátoru: 14,5 mm)
IX	Speciální zemnicí elektroda
	Iridium

Velikost kovového pláště	
F	14 Ø x 19 mm, šestihran 16,0 mm
G	14 Ø x 19 mm, šestihran 20,8 mm
J	12 Ø x 19 mm, šestihran 18,0 mm
K	12 Ø x 19 mm, šestihran 16,0 mm
M	10 Ø x 19 mm, šestihran 16,0 mm
T	Typ s kónickým usazením 14 Ø x 17,5 mm, šestihran 16,0 mm (PTR5A: 14 Ø x 25 mm, šestihran 16,0 mm)

OZNACZENIA ŚWIEC ZAPŁONOWYCH NGK

średnica gwintu	rozwartość klucza sześciokątnego	rodzaj budowy	wartość cieplna	długość gwintu
A	25,4 mm	L	2	E
B	20,8 mm	M	4	H
C	16,0 mm	P	5	L
D	18,0 mm	R	6	EH
E	13,0 mm	U	7	
G	23,8 mm	Z	8	F
J	18,0 mm		(85)	
AB	20,8 mm		9	
BC	16,0 mm		(95)	
BK	16,0 mm (Wersja ISO serii BCP)		10	
DC	16,0 mm		(105)	
			11	
			12	
			13	



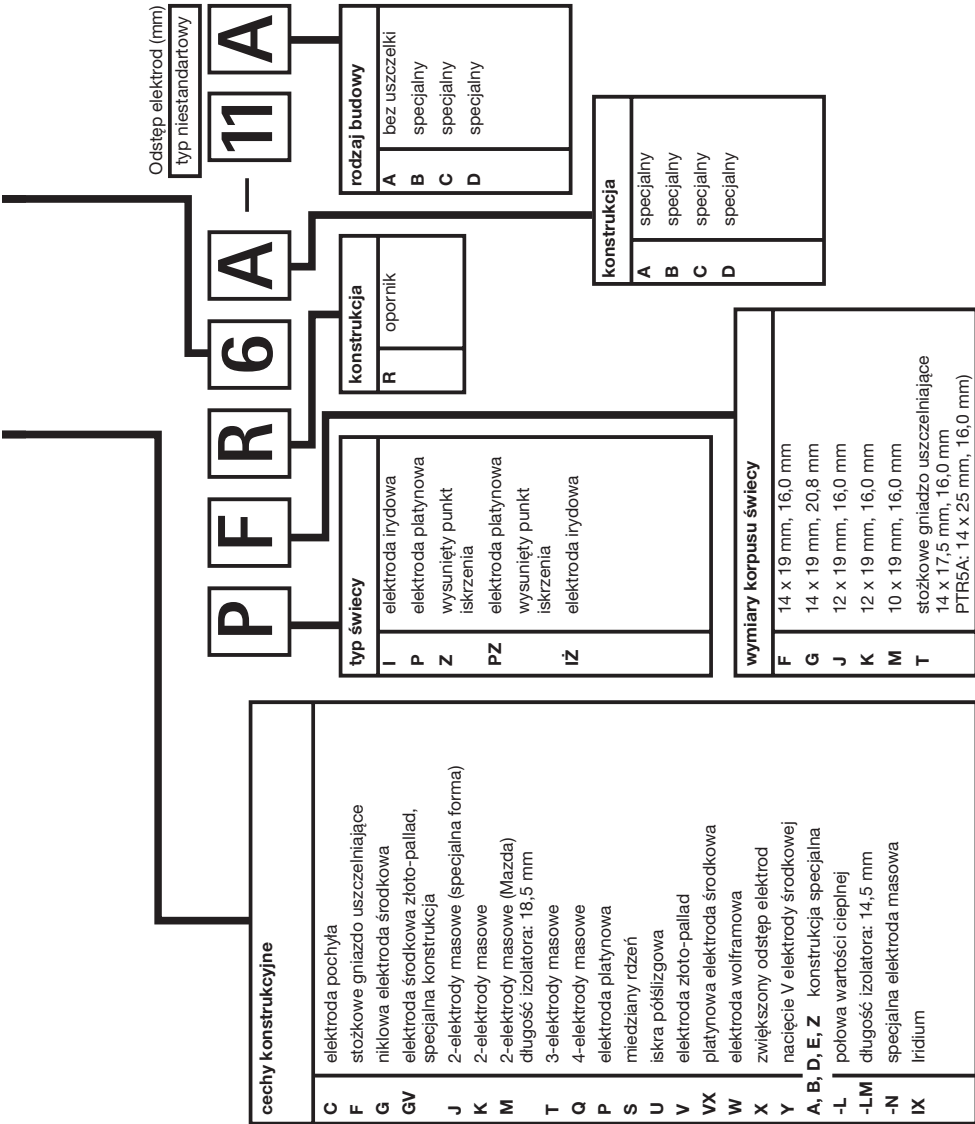

МАРКИРОВАЧНЫЕ МЕТКИ НА СВЕЧАХ ЗАЖИГАНИЯ ФИРМЫ NGK

* Здесь указаны стандартные обозначения. Таюке имеются несколько нестандартных обозначений.

Диаметр резьбы	Размер 6-гранного ключа	Особенности конструкции	Калильное число	Длина резьбы
A 18 мм	25,4 мм	L Компактный тип (Shorty)	2 Горячее ←	E 19,0 мм
B 14 мм	20,8 мм	M Компактный тип (Bantam)	4	H 12,7 мм
C 10 мм	16,0 мм	P Смещенный вперед наконечник изолятора	5	L 11,2 мм
D 12 мм	18,0 мм	R Тип с резистором	6	EH резьба до середины
E 8 мм	13,0 мм	U Тип полуперхностного или разряда	7	Общая длина: 19,0 мм
G PF 1/2	23,8 мм	Z Тип индукционного резистора	8 (85)	Длина резьбы: 12,7 мм
J 12 мм	18,0 мм		9 (95)	Конусное седло A-F тип 10,9 мм
AB 18 мм	20,8 мм		10 (105)	B-F тип 11,2 мм
BC 14 мм	16,0 мм		11	B-EE тип 17,5 мм
BK 14 мм	16,0 мм		12	
DC 12 мм	16,0 мм		13 Холодное	



Зазор свечи (мм)

Нет. Стандартный зазор

11A

6A

RF

P

Конструкция искрообразующего наконечника и т. п.	
C	Заземленный электрод с низким углом
F	Конусное седло
G	Средний электрод из тонкого никелевого сплава
GV	Средний электрод особой конструкции из золота - палладия
J	Удлиненные 2-заземленные электроды
K	2-заземленные электроды
M	2-заземленные электроды для роторного двигателя Mazda или длины изолятора: 18,5 мм
T	3-заземленные электроды
Q	4-заземленные электроды
P	Платиновый электрод
S	Стандарт электрод из меди
U	Тип полуповерхностного разряда
V	Средний электрод из золота - палладия
VX	Средний электрод из платины и особый заземленный электрод
W	Вольфрамовый электрод
X	Зазор для увеличения производительности
Y	Средний электрод с V-образной выемкой
A, B, D, E, Z	Особый дизайн
-L	Половина карильного числа, напр.: DRBESI=DR7,5E5 диапазон
-LM	Компактный тип (длина изолятора: 14,5 мм)
-N	Особый заземленный электрод
IX	Иридий

Типы свечей зажигания	
I	С иридиевым электродом
P	С платиновым электродом
Z	С увеличенным зазором
PZ	С платиновым электродом и увеличенным зазором
IZ	С иридиевым электродом и увеличенным зазором

Конструкция	
R	Резистор

Особенность	
A	Беспрокладочный тип
B	Особая
C	Особая
D	Особая

Конструкция	
A	Особая конструкция
B	Особая конструкция
C	Особая конструкция
D	Особая конструкция

Размеры металлического корпуса	
F	14 Ш X 19 мм 16,0 мм., 6-гранник
G	14 Ш X 19 мм 20,8 мм., 6-гранник
J	12 Ш X 19 мм 18,0 мм., 6-гранник
K	12 Ш X 19 мм 16,0 мм., 6-гранник
M	10 Ш X 19 мм 16,0 мм., 6-гранник
T	Тип конусного седла 14 Ш X 17,5 мм 16,0 мм., 6-гранник (PTRSA-14 Ш X 25 мм 16,0 мм., 6-гранник)

NGK GYÚJTÓGYERTYA JELZÉSEK MAGYARÁZATA

* Csak az általános típusok magyarázata, néhány extrém típust nem tartalmaz.

MENETÁTMÉRŐ	KULCSNYILÁS	KIVITEL	HŐÉRTÉK	MENETHOSSZ
A	18 mm	L	2	E
B	14 mm	M	4	H
C	10 mm	P	5	L
D	12 mm	R	6	EH
E	8 mm	U	7	nem végig menetes teljes
G	PF 1/2	Z	8	hossz: 19,0 mm
J	12 mm		(85)	menethossz: 12,7 mm
AB	18 mm		(95)	kúpös ülék
BC	14 mm		10	A-F
BK	14 mm		(105)	10,9 mm
DC	12 mm	BCP típus ISO verziója	11	B-F
			12	B-EF
			13	17,5 mm



ELEKTRODAHÉZAG (mm)

nincs betű átalános

11A

6A

PFR

JELLEG	
A	tömítés nélkül
B	speciális
C	speciális
D	speciális

ZAVARSZÜRÉS	
R	ellenállással

GYERTYATÍPUS	
I	irídium elektroda
P	platina elektroda
Z	előrehúzott szikraköz
PZ	platina elektroda + előrehúzott szigetelőcsúcs
IZ	irídium elektroda + előrehúzott szigetelőcsúcs

KONSTRUKCIÓS JELLEMZŐK

A	speciális
B	speciális
C	speciális
D	speciális

GYERTYATEST MENETMÉRLET	átmérő X hossz	MÉRETEK, KÜLCSNYILÁS
F	14 X 19 mm	16,0 mm
G	14 X 19 mm	20,8 mm
J	12 X 19 mm	18,0 mm
K	12 X 19 mm	16,0 mm
M	10 X 19 mm	16,0 mm
T	kúpós 14 X 17,5 mm PTR5A: 14 X 25 mm	16,0 mm 16,0 mm

KONSTRUKCIÓS JELLEMZŐK

C	ferde testelektroda
F	kúpós ülék
G	nikkel középelektroda (versenygyertya)
GV	arany-palládium középelektroda + speciális konstrukció
J	előrehúzott 2 testelektroda
K	2 testelektroda
M	2 testelektroda Mazda Wankel motor, szigetelési hossz 18,5 mm
T	3 testelektroda
Q	4 testelektroda
P	platina elektroda
S	rézmagos középelektroda
U	fél-kúszószikrárs típus
V	arany-palládium középelektroda
VX	platina középelektroda + speciális testelektroda
W	wolfram elektroda
X	megnövelt elektroдахézag
Y	V-bevágású középelektroda
A, B, D, E, Z	speciális konstrukció
-L	felezett hőérték
-LM	kompakt típus, szigetelési hossz 14,5 mm
-N	speciális testelektroda
IX	Iridium

ΣΥΜΒΟΛΑ ΣΧΕΔΙΑΣΗΣ ΠΟΥ ΧΡΗΣΙΜΟΠΟΙΟΥΝΤΑΙ ΣΤΑ ΜΠΟΥΖΙ NGK

* Χρησιμοποιούνται οι συνήθεις κανονισμοί. Υπάρχουν επίσης ορισμένα ασυνήθιστα σύμβολα

Μέγεθος σπειρώματος	Εξαγωνικό μέγεθος	Τύπος κατασκευής	Αριθμός θερμοκρασιακής κατατάξης	Απόσταση σπειρώματος
A	18 mm	L Συμπαγής τύπος (Shorty)	2 Υψηλότερη θερμοκρασία	E 19,0 mm
B	14 mm	M Συμπαγής τύπος (Bantam)	4	H 12,7 mm
C	10 mm	P Τύπος με προεξέχοντα μονωτήρα	5	L 11,2 mm
D	12 mm	R Τύπος με αντίσταση	6	EH Σπειρώμα κατά το ήμισυ
E	8 mm	U Τύπος εκφόρτισης επιφάνειας	7	Συνολο: 19,0 mm
G	PF 1/2	Z Τύπος με επαγωγική αντίσταση	8	Σπειρώμα: 12,7 mm
J	12 mm		(85)	Τύπος κωνικής βάσης
AB	18 mm		9	Τύπος A-F
BC	14 mm		(95)	10,9 mm
BK	14 mm (Τύπος ISO σε BCP)		10 (105)	Τύπος B-F
DC	12 mm		11	11,2 mm
			12	Τύπος B-EF
			13	17,5 mm

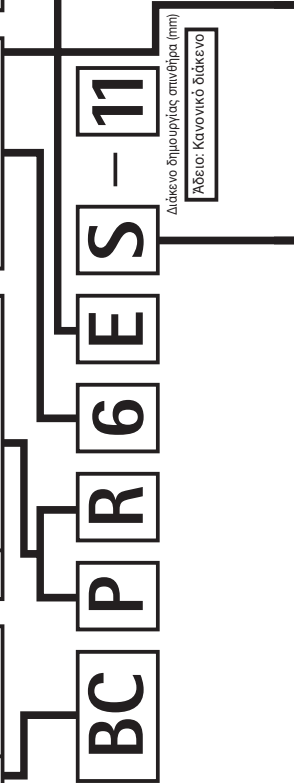

Διάκενο δημιουργίας σπινθήρα (mm)

Άξονας: Κανονικό διάκενο

P F R 6 A - 11 A

Τύπος	
A	Τύπος χωρίς παρέμβυσμα
B	Ειδικός
C	Ειδικός
D	Ειδικός
.	.
.	.

Κατασκευή	
R	Αντίσταση

Τύπος μπουζί	
I	Ηλεκτρόδιο ιριδίου
P	Ηλεκτρόδιο από πλατίνα
Z	Προεκτεταμένο διάκενο
PZ	Ηλεκτρόδιο από πλατίνα και προεκτεταμένο διάκενο
IZ	Ηλεκτρόδιο ιριδίου και προεκτεταμένο διάκενο

Κατασκευή	
A	Ειδική σχεδίαση
B	Ειδική σχεδίαση
C	Ειδική σχεδίαση
D	Ειδική σχεδίαση
.	.
.	.

Μέγεθος μεταλλικού κελύφους	
F	14 Ø X 19 mm, 16,0 mm εξαγωνικό
G	14 Ø X 19 mm, 20,8 mm εξαγωνικό
J	12 Ø X 19 mm, 18,0 mm εξαγωνικό
K	12 Ø X 19 mm, 16,0 mm εξαγωνικό
M	10 Ø X 19 mm, 16,0 mm εξαγωνικό
T	Τύπος κωνικής βάσης 14 Ø X 17,5 mm, 16,0 mm εξαγωνικό (PTF5A: 14 Ø X 25 mm, 16,0 mm εξαγωνικό)

Κατασκευή άκρου ανάφλεξης, κ.λπ.	
C	Ηλεκτρόδιο γείωσης μικρής κλίσης
F	Κωνική βάση
G	Κεντρικό ηλεκτρόδιο επεξεργασμένου κράματος νικελίου
GV	Κεντρικό ηλεκτρόδιο χρυσού – παλαδίου και ειδική κατασκευή
J	2 προεκτεταμένα ηλεκτρόδια γείωσης
K	2 ηλεκτρόδια γείωσης
M	2 ηλεκτρόδια γείωσης για περιριστροφικούς κινητήρες Mazda ή Μήκος μονωτήρα: 18,5 mm
T	3 ηλεκτρόδια γείωσης
O	4 ηλεκτρόδια γείωσης
P	Ηλεκτρόδιο από πλατίνα
S	Κεντρικό ηλεκτρόδιο με πυρήνα από χαλκό
U	Τύπος εκφύρτισης ημι-επιφανείας
V	Κεντρικό ηλεκτρόδιο χρυσού – παλαδίου
VX	Κεντρικό ηλεκτρόδιο από πλατίνα και ειδικό ηλεκτρόδιο γείωσης
W	Ηλεκτρόδιο βολφραμίου
X	Διάκενο ενίσχυσης
Y	Κεντρικό ηλεκτρόδιο με ατσάλι σε σχήμα V
A, B, D, E, Z	Ειδική σχεδίαση
-L	Μισό εύρος θερμοκρασίας
-LM	Συμπληγής τύπος (Μήκος μονωτήρα: 14,5 mm)
-N	Ειδικό ηλεκτρόδιο γείωσης
IX	Iridium

NGK bujilerinin üzerindeki karakterler ve açıklamaları.

Birçok tanım mevcut olup aşağıda tipik bir örnek verilmiştir.

	Diş çapı	Anahtar ağzaı	Yapısal özellik	Isı değeri	Paso uzunluğu
A	18 mm	25,4 mm	L Bantam tipi	2 Sıcak	E 19,0 mm
B	14 mm	20,8 mm	M Kompakt tip	4	H 12,7 mm
C	10 mm	16,0 mm	P Öne alınmış izolatör uç	5	L 11,2 mm
D	12 mm	18,0 mm	R Dirençli tip	6	EH Toplam uzunluk: 19,0 mm
E	8 mm	13,0 mm	U Boşalım tipi yada ilave kıvılcım yollu	7	Yiv uzunluğu: 12,7 mm
G	PF 1/2	23,8 mm	Z Dirençli tip (endüktif)	8	F Konik gövdeli tip A-F Tip 10,9 mm B-F Tip 11,2 mm B-EF Tip 17,5 mm
J	12 mm	18,0 mm		(85)	
AB	18 mm	20,8 mm		9	
BC	14 mm	16,0 mm		(95)	
BK	14 mm	16,0 mm		10	
DC	12 mm	16,0 mm		(105)	

BC P R 6 E S - 11

Tırnak aralığı (mm)

Standart tip değii

Tırmak aralığı (mm)
Standart tip değil

11A

6A

R

P

Yapısal özellik	
C	Eğik elektrot
F	Konik gövdeli tip
G	Yarış bujisi (Nikel elektrotlu)
GV	Altın-Paladium elektrotlu
J	2-Tırmaklı (Özel tip)
K	2-Tırmaklı
M	2-Tırmaklı (Mazda) izolatör uzunluğu = 18,5 mm
T	3-Tırmaklı
Q	4-Tırmaklı
P	Platin Tırmaklı
S	Standart tip
U	ilave kıvılcım tipi
V	Altın-Paladium (elektrot)
VX	Platin elektrot
W	Wolftram elektrot
X	Artırılmış tırmak aralığı
Y	V-Yiv göbekli elektrot
A, B, D, E, Z	Özel yapıım
-L	Yanım ısı: değeri, Örnek: DR8ESL = DR7,5ES
-LM	İzolatör uzunluğu = 14,5 mm
-N	Özel tırmaklı
IX	İridium

Bujii tipi	
I	İridium elektrot
P	Platin elektrot
L	Paso uzunluğu 26,5 mm
Z	Öne alınmış ateşleme pozisyonu
PL	Platin elektrot ve paso uzunluğu 26,5 mm
PZ	Platin elektrot ve artırılmış tırmak aralığı
IZ	İridium elektrot ve artırılmış tırmak aralığı

Yapısal özellik	
R	Dirençli tip

Yapısal özellik	
A	Contasız
B	Özel
C	Özel
D	Özel

Yapısal özellik	
A	Özel
B	Özel
C	Özel
D	Özel

Bujii ölçüsü	
F	14 ø x 19 mm, 16,0 mm
G	14 ø x 19 mm, 20,8 mm
J	12 ø x 19 mm, 18,0 mm
K	12 ø x 19 mm, 16,0 mm
M	10 ø x 19 mm, 16,0 mm
T	Konik gövdeli tip 14 ø x 17,5 mm, 16 mm (PTRSA: 14 ø x 17,5 mm, 16 mm)

ANZIEHDREHMOMENTE DER ZÜNDKERZEN TIGHTENING TORQUES FOR SPARK PLUGS • COUPLES DE SERRAGE DES BOUGIES PAR DE APRIETE PARA LAS BUJÍAS DE ENCENDIDO • ÅDRAGNINGSMOMENT VID TÄNDSTIFTSMONTERING



	Zündkerze mit flachem Sitz (mit Dichtung) Flat seat type (with gasket) Modèle à siège plat (avec joint) Tipo de asiento plano (con em Paquetadura) Tändstift med packning	18 mm	14 mm	12 mm	10 mm	8 mm	18 mm	14 mm	Zündkerze mit konischem Sitz Conical seat type Modèle à siège conique Tipo de asiento cónico För koniskt säte
 Gussisenkopf Cast iron head Culasse en fonte Culata de hierro fundido Cylindlock av gjutjärn	35-46 N · m (3,5-4,5 m·kg) (25,3-32,5 lbs·ft)	25-35 N · m (2,5-3,5 m·kg) (18,0-25,3 lbs·ft)	15-25 N · m (1,5-2,5 m·kg) (10,8-18,0 lbs·ft)	10-15 N · m (1,0-1,5 m·kg) (7,2-10,8 lbs·ft)	20-30 N · m (2,0-3,0 m·kg) (14,5-21,6 lbs·ft)	15-25 N · m (1,5-2,5 m·kg) (10,8-18,0 lbs·ft)	20-30 N · m (2,0-3,0 m·kg) (14,5-21,6 lbs·ft)	10-20 N · m (1,0-2,0 m·kg) (7,2-14,5 lbs·ft)	
Aluminiumkopf Aluminium head Culasse en aluminium Culata de aluminio Cylindlock av lättmetall	35-40 N · m (3,5-4,0 m·kg) (25,3-28,9 lbs·ft)	25-30 N · m (2,5-3,0 m·kg) (18,0-21,6 lbs·ft)	15-20 N · m (1,5-2,0 m·kg) (10,8-14,5 lbs·ft)	10-12 N · m (1,0-1,2 m·kg) (7,2-8,7 lbs·ft)	8-10 N · m (0,8-1,0 m·kg) (5,9-7,2 lbs·ft)	20-30 N · m (2,0-3,0 m·kg) (14,5-21,6 lbs·ft)	20-30 N · m (2,0-3,0 m·kg) (14,5-21,6 lbs·ft)	10-20 N · m (1,0-2,0 m·kg) (7,2-14,5 lbs·ft)	

Zum installieren der Zündkerzen, diese zuerst mit der Hand festziehen und dann mit einem Zündkerzenschlüssel 1/2 bis 2/3 Umdrehungen festziehen (Zündkerzen mit Kegeldichtstift nur 1/16 Umdrehung).
Getrauchte Zündkerzen und Kerzen mit 8, 10 und 12 mm Gewindedurchmesser ausschließlich mit Drehmomentschlüssel montieren. Vor der Montage auf Sauberkeit der Kerzenwinde und der Gewinde achten.
To install new spark plugs in the engine, first tighten them by fingers, then retighten about 1/2 to 2/3 (180°-270°) (Flat seat plugs with 8 mm thread size: about 1/3 (120°), Conical seat plugs: about 1/16 (23°)) of a turn using a plug wrench, and reinstalled spark plugs with used gasket require 1/12-1/8 (30°-45°) turn using a plug wrench.

Pour mettre en place de nouvelles bougies sur le moteur, il convient de les visser d'abord à la main puis de les serrer en utilisant une clé à bougie d'environ: 1/2 à 2/3 tour (180° à 270°) pour les bougies classiques à joint, 1/16 (23°) pour les bougies à joint usagées, il convient de les serrer de environ 1/12 à 1/8 de tour (30° à 45°) si l'aide d'une clé à bougie.

Para instalar unas bujías nuevas en el motor, primero apriétealas con los dedos, luego apriétealas 1/2-2/3 (180°-270°) vuelta con una llave de bujías *Bujías de asiento cónico alrededor de 1/16 (23°). Bujías de rosca 8 mm y asiento plano, alrededor de 1/3 (120°), para reinstalar las bujías con la junta usada, apriete de 1/12-1/8 (30°-45°) de giro usando una llave de bujías.
Vid monterung av nya tändstift i motorn. Skruva ner det för hand tills det bottnar, dra sedan fast med en tändstiftsnyckel ca. 1/2-2/3-varv, 180°-270° (Stift med 8 mm gängdiameter och packing ca. 1/3-varv, 120° - Stift avsedda för koniskt säte ca. 1/16-varv, 23°). Återmontering av stift kräver ett mindre moment, 1/12-1/8-varv ca. 30°-45°.

Conversion Chart

Vergleichsliste

Tableau de comparaison thermique

Tabla de conversión equivalencias

Jämförelsetabell

- Note: This chart is furnished as a guide. Due to differences in design, materials, etc., plugs produced by various manufacturers do not have exactly the same heat range. See recommendations sections for specific engine application.
- Anmerkung: Diese Liste dient nur zur Information. Wegen der Unterschiede von Konstruktion, Werkstoffen usw. haben die Zündkerzen von verschiedenen Herstellern keinen miteinander übereinstimmenden Wärmebereich. Siehe unsere Empfehlungen für die richtige Anwendung der Zündkerzen.
- Notes: Cette liste est donnée comme guide. A cause de la différence en dessin, matériels etc., les bougies d'allumage produites par divers fabricans n'ont pas exactement la même gamme thermique. Voir section d'affectations pour utilisation exacte.
- Notas: Este cuadro se sirve de quia. Bujías que se producen por varios fabricantes no poseen exactamente el mismo alcance térmico debido a las diferencias en diseño, materiales etc. Véase sección de aplicaciones para el uso correcto.
- Observera: Denna tabell är endast avsedd som vägledning. På grund av avvikelser i utförande, material m.m. kan tändstift av olika fabrikat ej ha exakt samma värmetal. Se rekommendationstabellen för respektive motor.



APS	→ NGK	Bic*/IX
A11	B5HS	
A11P	BR5HS	
A14B	BP5HS	
A14B-2	BP5HS	
A14BM	BP5HS	
A14BP	BPR5HS	
A14DB	BP5ES	BPR5EIX
A14DBP	BPR5ES	BPR5EIX
A14DBPM	BPR5ES	BPR5EIX
A17B	BP6HS	BPR6HIX
A17DB	BP6ES	BPR6EIX
A17DB-10	BP6ES	BPR6EIX
A17DBM	BP6ES	BPR6EIX
A17DBP	BPR6ES	BPR6EIX
A17DBPM	BPR6ES	BPR6EIX
A20D	B7ES	
A23-2	B7HS	BR7HIX
A23B	BP7HS	BPR7HIX
AY17DBPM	BCPR6ES-11	BCPR6EIX-11
BERU	→ NGK	Bic*/IX
125/14/3	B5ES	
125/14/3A	BP5ES	BPR5EIX
12-5DU	D7EA	
14-10A	B4H	
14-10B	BP4HS	
14-10C	B4ES	
14-10D	BP4ES	
14-10E	B4	
14-10F	BP4	
14-2AS1	B9HCS	
14-3A1	B8HS	BR8HIX
14-3AS1	B8HVX	BR8HIX
14-3AU	B8HS	BR8HIX
14-3CS1	B8EVX	BR8EIX
14-3DP2	B8EVX	BR8EIX
14-4A1	B8HS	BR8HIX
14-4A2	B7HS	BR7HIX
14-4AS1	B8HVX	BR8HIX
14-4AU	B7HS	BR7HIX
14-4B2	BP7HS	BPR7HIX
14-4C1	B8ES	BR8EIX
14-4C2	B7ES	
14-4CS1	B8EVX	BR8EIX
14-4DP0	BP7ES	BPR7EIX
145/14	B5HS	
145/14/3	B5ES	
145/14/3A	BP5ES	BPR5EIX
145/14/5	B4	
145/14/5A	BP5S	
145/14/5AMX	BPM6A	
145/18	A6	

BERU	→ NGK	Bic*/IX
145/18K	AP5FS	
145/1A	BP5HS	
14-5A	B7HS	BR7HIX
14-5AU	B7HS	BR7HIX
14-5B	BP7HS	BPR7HIX
14-5BU	BP7HS	BPR7HIX
14-5C	B7ES	
14-5CS	B7ECS	
14-5D	BP7ES	BPR7EIX
14-5D1	BP7ES	BPR7EIX
14-5DP1	BP7ES	BPR7EIX
14-5DTU	BP6ET	PGR6D
14-5DU	BP7ES	BPR7EIX
14-5DUO	BP7ES	BPR7EIX
14-5E	B7S	
14-5F	BP6S	
14-6B	BP6HS	BPR6HIX
14-6BU	BP6HS	BPR6HIX
14-6C	B6ES	
14-6D	BP6ES	BPR6EIX
14-6D1	BP6ES	BPR6EIX
14-6DP0	BP6ES	BPR6EIX
14-6DTU	BP6ET	PGR6D
14-6DU	BP6ES	BPR6EIX
14-6DUO	BP6ESZ	PGR6D
14-7A	B6HS	BR6HIX
14-7AU	B6HS	BR6HIX
14-7B	BP6HS	BPR6HIX
14-7BU	BP6HS	BPR6HIX
14-7C	B6ES	
14-7CU	B6ES	
14-7D	BP6ES	BPR6EIX
14-7DTU	BP6ET	PGR6D
14-7DU	BP6ES	BPR6EIX
14-7DUO	BP6ESZ	PGR6D
14-7E	B6S	
14-7F	BP6S	
14-8A	B5HS	
14-8AU	B5HS	
14-8B	BP5HS	
14-8BU	BP5HS	
14-8C	B5ES	
14-8C1	B6ES	
14-8D	BP5ES	BPR5EIX
14-8DTU	BP5ET	
14-8DTU EA1,0	BP5ET-10	
14-8DU	BP5ES	BPR5EIX
14-8DUO	BP5ES	BPR5EIX
14-8E	B4	
14-8F	BP5S	
14-8LUR	ZGR5A	
14-9C	B5ES	

Bic* = Best in class



BERU	→ NGK	Bic*/IX
14-9D	BP5ES	BPR5EIX
14-9DTU	BP5ET	
14-9DU	BP5ES	BPR5EIX
14-9DUO	BP5ES	BPR5EIX
14-9EUO	B4LM	
14F-03DAR	BKR6EK	BKR6EQUP
14F4DPUR03	PPR08-9	
14F-5DU	BCP7ES	BCPR7EIX
14F6DPUR021	PPR7Q	
14F-6DSR	BKR6E	BKR6EIX
14F-6DTU	BCP6ET	BCPR6EIX-11
14F-6DUO	BCP6ES	BCPR6EIX-11
14F-6DUOR	BKR6E	BKR6EIX
14F-7DU	BCP6ES	BCPR6EIX-11
14F-7DUO	BCP6ES	BCPR6EIX-11
14F-7DUOR	BKR6E	BKR6EIX
14F7HUR2	ZFR5P-G	
14F-7LDJR	BKR6EK	BKR6EQUP
14F-7LDUR4	BKR6EK	BKR6EQUP
14F-8DU	BCP5ES	BCPR5EIX-11
14F-8DU4	BCP5ES	BCPR5EIX-11
14F-8DUO	BCP5ES	BCPR5EIX-11
14F-8LDUSR	BKR6EK	BKR6EQUP
14F-8LUR	ZFR5F	ZFR5FIX-11
14F-9DUO	BCP5ES	BCPR5EIX-11
14FGH-6DTUR	BKJUR7ET	PPR7Q
14FGH-78DPURX2	IFR6D10	
14FGH-7DTURX	BKJUR6ET-10	PPR6Q
14FGH-8DPURX2	IFR5D10	
14FGH-8DTURXO	BKJUR5ET	
14FGH-8DTURXO	BKJUR5ET	PPR6Q
14FGR-8DDU	BKR6EKUB	BKR6EQUP
14FGR-7CTU	BCPR7ET	
14FLR-8LDUX	BKR5EK	BKR5EIX
14FR-5DTU	BCPR7ET	
14FR-5DU	BCPR7ES	BCPR7EIX
14FR-6DU	BKR6E	BKR6EIX
14FR-6DUX	BCPR6ES-11	BCPR6EIX-11
14FR6LDU	BKR6EK	
14FR-6LDU3	BKR6EKE	
14FR-7DU	BKR6E	BKR6EIX
14FR-7DUX	BKR6ES-11	BKR6EIX-11
14FR-7DUX	BKR6E-11	BKR6EIX-11
14FR-7HUR2	ZFR5P-G	
14FR-7KPU	BKR6EP-8	
14FR-7KPUV	BCPR6EP-11	
14FR-7KPUX	BCPR6EP-11	
14FR-7KU	BKR6EY	BKR6EIX
14FR-7KUO	BKR6EYA	
14FR-7LDU	BKR6EKC	BKR6EIX
14FR-8DU	BCPR5ES	BCPR5EIX-11
14FR-8DU	BKR5E	BKR5EIX

BERU	→ NGK	Bic*/IX
14FR-8DUX	BCPR5ES-11	BCPR5EIX-11
14FR-8HU	BCRE527Y	
14FR-8KU	BKR5EY	BKR5EIX
14FR-8KUO	BKR5EYA	
14G-8DTU	BP6ET	PGR6D
14GH-7DTUR	BUR6ET	PGR6D
14GH-8DTUR	BUR5ET	PGR6D
14GH-8DTUREA	BUR5ET	
14GH-8DTURX	BUR5ET-10	PGR6D
14GR-8DTU	BPR5EQU	PGR6D
14K-5DU	BP7EFS	
14K-5DUO	BP7EFS	
14K-6D	BP6EFS	
14K-6DU	BP6EFS	
14K-6DUO	BP6EFS	
14K-7D	BP6EFS	
14K-7DU	BP6EFS	
14K-7DUO	BP6EFS	
14K-8DU	BP5EFS	
14K-8DUO	BP5EFS	
14K-9DU	BP5EFS	
14K-9DUO	BP5EFS	
14KGR-6KQU	BUR6EFSZ	
14KR-6BU	BPR6FS	
14KR-6DU	BPR6EFS	
14KR-6ZPPV	PTR5A-13	
14KR-7DUX	BPR6EFS	
14KR-8DPUOV	TR55	TR55IX
14KR-8MUV	PTR5A-13	
14R-11F	BP4	
14R-5DU	BPR7ES	BPR7EIX
14R-6B	BPR6HS	BPR6HIX
14R-6BU	BPR6HS	BPR6HIX
14R-6D	BPR6ES	BPR6EIX
14R-6DU	BPR6ES	BPR6EIX
14R-6DUX	BPR6ES-11	BPR6EIX-11
14R-6DUX	BUR6EA-11	
14R-7B	BPR6HS	BPR6HIX
14R-7BU	BPR6HS	BPR6HIX
14R-7CU	BR6ES	
14R-7D	BPR6ES	BPR6EIX
14R-7DU	BPR6ES	BPR6EIX
14R-7DUX	BPR6EY-11	BPR6EIX-11
14R-8DU	BPR5EY	BPR5EIX
14R-8DUX	BPR5ES-11	BPR5EIX-11
14R-9DU	GR4	GR4IX
14R-9DU	BPR5ES	BPR5EIX
14R-9EUO	BR4LM	
14S-5A	BLGH	
14S-5F	BPM7A	
14S-7A	BLGH	
14S-7F	BPM6A	

Bic* = Best in class



BERU	→	NGK	Bic*/IX
14S-8F		BPM6A	
14SR-6F		BPMR6A	
14-XAU		B6HS	BR6HIX
14Z-2C1		B9EVX	BR9EIX
14Z-3A1		B9HS	
14Z-3AU		B8HS	BR8HIX
14Z-3C1		B9ES	BR9EIX
14Z-3CU		B8ES	BR8EIX
14Z-4AU		B8HS	BR8HIX
14Z-6A2		B6HS	BR6HIX
14Z-7AU		B7HS	BR7HIX
160/14/3		B6ES	
175/14		B6HS	BR6HIX
175/14/3		B6ES	
175/14/3A		BP6ES	BPR6EIX
175/14/5		B6S	
175/14/5A		BP6S	
175/14/5AMX		BPM6A	
175/14/UK4		BL6H	
175/14A		BP6HS	BPR6HIX
175/18		A6	
175/18K		AP6FS	
18-10A		A6	
18-10AU		A6	
18-12B		AB2	
18-4A1		A7	
18-4A2		A7	
18-5A		A7	
18-5AS		A7	
18-5AU		A7	
18-7A		A6	
18-7AU		A7	
18-8A		A6	
18K-12B		AP5FS	
18K-6BU		AP6FS	
18K-7B		AP6FS	
18K-7BU		AP6FS	
18K-8B		AP5FS	
18K-8BU		AP5FS	
190/14Z		B6HS	BR6HIX
200/14/3		B6ES	
200/14/3A		BP6ES	BPR6EIX
200/14/3K		BP6EFS	
200/14A		BP6HS	BPR6HIX
215/14/3A		BP6ES	BPR6EIX
225/14		B7HS	BR7HIX
225/14/3		B7ES	
225/14/3A		BP7ES	BPR7EIX
225/14/3S		B7ECS	
225/14/5		B7S	
225/14/5A		BP6S	
225/14/5AMX		BPM7A	

BERU	→	NGK	Bic*/IX
225/14/UK4		BL6H	
225/14A		BP7HS	BPR7HIX
225/18		A7	
225/18S		A7	
230/14/3A		BP7ES	BPR7EIX
235/14/3P		BP7ES	BPR7EIX
240/14		B7HS	BR7HIX
240/14/3		B7ES	
240/14A		BP7HS	BPR7HIX
240/14S		B8HVX	BR8HIX
240/18		A7	
260/14		B8HS	BR8HIX
260/14/3		B8ES	BR8EIX
260/14S		B8HVX	BR8HIX
260/18		A8	
265/14/3P		B8EVX	BR8EIX
280/14		B8HS	BR8HIX
280/14/3S		B8EVX	BR8EIX
280/14/3Z		B9ES	BR9EIX
280/14Z		B9HS	
310/14/3Z		B9EVX	BR9EIX
310/14S		B9HCS	
45/18		AP5FS	
95/14		B4H	
95/14/3		B4ES	
95/14/3A		BP4ES	
95/14/5		B4	
95/14/5A		BP-4	
95/14A		BP4HS	
95/18		A6	
D 215/14/3 (14/5/C)		B7ES	
D175/14		B6HS	BR6HIX
D175/14/3		B6ES	
D200/14/3A		BP6ES	BPR6EIX
D215/14/3		BP6ES	BPR6EIX
D230/14/3A		BP7ES	BPR7EIX
G 3/18		A9EFP	
G 5		---	
G 6		---	
RS16		BP6HVX	BPR6HIX
RS18		BP7HVX	BPR7HIX
RS33		BPR5EVX	BPR5EIX
RS35		BP6EVX	BPR6EIX
RS37		BP7EVX	BPR7EIX
RS39		BP7EVX	BPR7EIX
Z 1		BP5ES	BPR5EIX
Z 2		BP5ET	
Z 3		ZGR5A	
Z 4		ZFR5F	ZFR5FIX-11
Z 5		BCP5ES	BCPR5EIX-11
Z 6		BP5EFS	
Z 7		BP5EFS	

Bic* = Best in class



BERU	→ NGK	Bic*/IX
Z 8	BPR5ES	BPR5EIX
Z 9	BPR5ES-11	BPR5EIX-11
Z 10	BP6HS	BPR6HIX
Z 11	BP6ES	BPR6EIX
Z 12	BP6ET	PGR6D
Z 13	BKR6E	BKR6EIX
Z 14	BKR6EK	BKR6EQUP
Z 15	BKR6E	BKR6EIX
Z 16	BCPR6ES-11	BCPR6EIX-11
Z 17	BP6EFS	
Z 18	BP6EFS	
Z 19	BPR6HS	BPR6HIX
Z 20	BPR6ES	BPR6EIX
Z 21	BPR6ES-11	BPR6EIX-11
Z 22	BP6ES	BPR6EIX
Z 23	BKR6E	BKR6EIX
Z 24	BKR6E	BKR6EIX
Z 25	BP6EFS	
Z 26	BPR6EFS	
Z 27	BPR6ES	BPR6EIX
Z 28	BPR6ES-11	BPR6EIX-11
Z 29	BCP7ES	BCPR7EIX
Z 30	BCPR7ES	BCPR7EIX
Z 31	BP7EFS	
Z 32	AP6FS	
Z 33	AP6FS	
Z 35	D7EA	
Z 36	D7EA	
Z 37	B9HS	
Z 38	B9ES	BR9EIX
Z 39	B8HS	BR8HIX
Z 40	B7HS	BR7HIX
Z 41	BP7HS	BPR7HIX
Z 42	BP7ES	BPR7EIX
Z 43	BP7ES	BPR7EIX
Z 44	BP6ET	PGR6D
Z 45	BCPR7ET	
Z 46	BP7EFS	
Z 47	BPR7ES	BPR7EIX
Z 48	BP6HS	BPR6HIX
Z 49	BPR6FS	
Z 50	BP6ESZ	PGR6D
Z 51	BP6ET	PGR6D
Z 52	BCP6ET	BCPR6EIX-11
Z 53	BCP6ET	BCPR6EIX-11
Z 54	BCP6ES	BCPR6EIX-11
Z 55	BP6EFS	
Z 56	BP6EFS	
Z 57	B6HS	BR6HIX
Z 58	B6ES	
Z 59	BR6ES	
Z 60	BCPR7ET	

BERU	→ NGK	Bic*/IX
Z 61	BP6ESZ	PGR6D
Z 62	BP6ESZ	PGR6D
Z 63	BCP6ES	BCPR6EIX-11
Z 64	BCP6ES	BCPR6EIX-11
Z 66	BP6EFS	
Z 67	BPR6EFS-13	
Z 68	B5HS	
Z 69	BP5ESZ	BPR5EIX
Z 70	BP5ESZ	BPR5EIX
Z 71	BCP5ES	BCPR5EIX-11
Z 72	BCPR5ES	BCPR5EIX-11
Z 73	BCPR5ES-11	BCPR5EIX-11
Z 74	BKR5EK	BKR5EIX
Z 75	BUR5ET	PGR6D
Z 76	BP5ES	BPR5EIX
Z 77	BP5ESZ	BPR5EIX
Z 78	BP5ET	
Z 79	BCP5ES	BCPR5EIX-11
Z 80	BP5EFS	
Z 81	BP5EFS	
Z 82	BPR5ES	BPR5EIX
Z 83	B4LM	
Z 84	BR4LM	
Z 85	B6HS	BR6HIX
Z 86	A7	
Z 87	A7	
Z 88	A6	
Z 89	BKUR6ET	PFR6Q
Z 90	BKUR6ET-10	PFR6Q
Z 91	BUR6ET	PGR6D
Z 92	BUR5ET	PGR6D
Z 93	BUR5ET-10	PGR6D
Z 94	BPR5EQU	PGR6D
Z 95	BPR6EFS	
Z 97	PTR5A-13	
Z 99	BCPR6ES-11	BCPR6EIX-11
Z 100	BKR6ES	BKR6EIX
Z 101	BKR6EK	BKR6EQUP
Z 103	BP7ES	BPR7EIX
Z 104	BP6ES	BPR6EIX
Z 105	BKR6E	BKR6EIX
Z 107	BP4	
Z 112	B4	
Z 144	BUR6EFSZ	
Z 145	BKR6EKUB	BKR6EQUP
Z 148	TR55	TR55IX
Z 149	BCPR6EP-11	
Z 150	BCPR6EP-11	
Z 151	BKR6EP-8	
Z 152	BCRE527Y	
Z 153	BKR5EY	BKR5EIX
Z 154	BKR5EYA	



BERU	→ NGK	Bic*/IX
Z 155	BKR6EY	BKR6EIX
Z 156	BKR6EYA	
Z 157	BKR6EYA-11	
Z 158	ZFR6F-11	ZFR6FIX-11
BMW	→ NGK	Bic*/IX
11127675485	KR9CI	
11127699116	KR9CI	
12120141871	BKR6EQU	
12121435955	BKR6EQU	
12122343144	D8EA	DR8EIX
12127650676	BKR7EKC	
12127653439	CR8EB	CR8EIX
12127653771	BKR7EKC	
12127671301	DCPR8EKC	
12127671302	BKR7EKC	
12127677560	DCPR8EKC	
12129061870	ZFR5F	ZFR5FIX-11
12129063428	BKR6EK	BKR6EQU
12129064617	BKR6EK	BKR6EQU
12129064619	BKR6EK	BKR6EQU
12129064656	BKR6EK	BKR6EQU
12129065366	BKR6EK	BKR6EQU
12129069048	PKR7A	
12129071003	BKR6EQU	
BOSCH	→ NGK	Bic*/IX
D10B	AP5FS	
D10BC	AP5FS	
D6B	AP6FS	
D6BC	AP6FS	
D6BP	AP6FS	
D7A	A6FS	
D7AC	A6FS	
D7B	AP6FS	
D7BC	AP6FS	
D7BP	AP6FS	
D8A	A5FS	
D8AC	A5FS	
D8B	AP5FS	
D8BC	AP5FS	
D8BP	AP5FS	
D9B	AP5FS	
D9BC	AP5FS	
DR10B	APR5FS	
DR10BC	APR5FS	
DR6BC	APR6FS	
DR6BP	APR6FS	
DR7BC	APR6FS	
DR7BP	APR6FS	
DR8B	APR5FS	
DR8BC	APR5FS	

BOSCH	→ NGK	Bic*/IX
DR8BP	APR5FS	
DR9B	APR5FS	
DR9BC	APR5FS	
F04DAR	BKR6EK	BKR6EQU
F09CS	R7115-10	
F09CS	R7114-10	
F2CS	R7114-9	
F3CS	R7114-9	
F4CS	R6205-8	
F5DC	BCP7ES	BCPR7EIX
F5DP	BCP7ES	BCPR7EIX
F5DPOR	PFR7B	
F5DTC	BCP7ET	BCP7EVX
F6DC	BCP6ES	BCPR6EIX-11
F6DCO	BCP6ES	BCPR6EIX-11
F6DCOR	BKR6E	BKR6EIX
F6DCX	BCP6ES-11	BCPR6EIX-11
F6DP	BCP6ES	BCPR6EIX-11
F6DPOR	PFR6Q	
F6DPX	BCP6ES-11	BCPR6EIX-11
F6DSR	BKR6EVX	
F6DTC	BCP6ET	BCPR6EIX-11
F6KPP332S	PFR6Q	
F6LTCR	BKUR7ET	PFR7Q
F6MPP332	ILFR6A	
F7DC	BCP6ES	BCPR6EIX-11
F7DCO	BCP6ES	BCPR6EIX-11
F7DCOR	BKR6E	BKR6EIX
F7DCX	BCP6ES-11	BCPR6EIX-11
F7DER	BKR6E	BKR6EIX
F7DP	BCP6ES	BCPR6EIX-11
F7DPP332	IFR6D10	
F7DTC	BCP6ET	BCPR6EIX-11
F7HER2	ZFR5P-G	
F7HPP22	BKUR6ET-10 / PFR6Q	
F7HPP222	PZFR5D-11	
F7HPP222U	PZFR6J-11	
F7KPP332U	PFR6X-11	
F7KTCR	BKUR6ET-10	PFR6Q
F7LOR2	ZFR6F-11	ZFR6FIX-11
F7LCR	ZFR6A-11	
F7LDCR	BKR6EK / BKR6EQU	BKR6EQU
F7LTCR	BKUR6ET-10 / PFR6Q	PFR6Q
F8DC	BCP5ES	BCPR5EIX-11
F8DC4	BCP5ES	BCPR5EIX-11
F8DCO	BCP5ES	BCPR5EIX-11
F8DCOR	BCPR5ES / BKR5E	BCPR5EIX-11
F8DCX	BCP5ES-11	BCPR5EIX-11
F8DPER	IFR5D10	
F8DPP332	IFR5D10	
F8KTCR	BKUR5ET	PFR6Q
F8LCR	ZFR5F	ZFR5FIX-11

Bic* = Best in class



BOSCH	→ NGK	Bic*/IX
F8LCR2	ZFR5F	ZFR5FIX-11
F8LDCR	BKR6EK	BKR6EQUIP
F9DCO	BCP4ES	
F9LCR	ZFR4F-11	
FGR5KQEO	BKR7EQUP	
FGR6HQEO	ZFR6S-Q	
FGR6KQC	BKR6EQUP	
FGR6KQE	BKR6EQUP	
FGR7DQEO	BKR6EKUB	BKR6EQUIP
FGR7DQP	BKR6EQUP	
FGR7KQC	BKR6EQUP	
FGR7KQE	BKR6EQUP	
FGR7KQEO	BKR6EQUP	
FGR8KQEO	BKR5EQUA	
FGR8MQPE	PLFR5A-11	
FLR8LDCU	BKR5EK	BKR5EIX
F03DAR	BCPR7ER / BKR6EK	
FQR8LEU2	ZFR5F	ZFR5FIX-11
FR10DCX	BCPR4ES-11	
FR10DX	BCPR4ES-11	
FR2LS	BCPR6ES	
FR5DC	BCPR7ES	BCPR7EIX
FR5DCX	BCPR7ES-11	BCPR7EIX-11
FR5DP	BCPR7ES	BCPR7EIX
FR5DTC	BCPR7ET	
FR5LDC	BKR7EKC	
FR6DC	BKR6E	BKR6EIX
FR6DC2 0,7	BKR6E	BKR6EIX
FR6DCO	BKR6EK	
FR6DCX	BCPR6ES-11	BCPR6EIX-11
FR6DDC	BKR7EKC	
FR6DP	BKR6E	BKR6EIX
FR6DP1X	PFRR6J-11	
FR6DPX	BCPR6ES-11	BCPR6EIX-11
FR6DTC	BCPR6ET	
FR6DTCW	BKR5EKC	
FR6KDC	BKR6EZ	
FR6KTC	BKJR6ETB	
FR6LDC	BKR6EKC	BKR6EIX
FR6LDC	BKR6EK	BKR6EQUIP
FR6MPP10	LFRR6ap	
FR6Mpp10	PLFR6A	
FR7DC	BKR6E	BKR6EIX
FR7DC2	BKR6E	BKR6EIX
FR7DCO	BKR6E	BKR6EIX
FR7DCX	BCPR6ES-11	BCPR6EIX-11
FR7DE	BKR6EZ	
FR7DP	BKR6E	BKR6EIX
FR7DP1X	PFRR6B-11	
FR7DPP10	BKR6EVX	
FR7DPX	BCPR6ES-11	BCPR6EIX-11
FR7DTC	BCPR6ET	

BOSCH	→ NGK	Bic*/IX
FR7HE2	ZFR5P-G	
FR7KWC	BKR6EP-13	
FR7KDC	BKR6EZ	
FR7KPP332	IZFR6H11	
FR7LC2	BKR6E	BKR6EIX
FR7LCX	ZFR6F-11	ZFR6FIX-11
FR7LDC	BKR6EKC	BKR6EIX
FR7NPP332	ILZFR6D11	
FR8DC	BKR5ES	BKR5EIX
FR8DCO	BKR5ES	BKR5EIX
FR8DCX	BKR5ES-11	BKR5EIX-11
FR8DPX	BKR5ES-11	BKR5EIX-11
FR8DS	BKR5EVX	
FR8DX	BKR5ES-11	BKR5EIX-11
FR8HP	ZFR5F-11	ZFR5FIX-11
FR8KCU	BKR5EYA-11	
FR8LCX	ZFR6F-11	ZFR6FIX-11
FR8LDC	BKR5EK	BKR5EIX
FR8LDC4	BKR5EK	BKR5EIX
FR8ME	LFRR5B	
FR9DCX	BCPR4ES-11	
FR9HC	ZFR4F-11	
H10B	BP4FS	
H10BC	BP4FS	
H2CS	B9EFS	
H3CS	B8EFS	
H5D	BP7EFS	
H5DC	BP7EFS	
H5DCO	BP7EFS	
H5DP	BP7EFS	
H6B	BP6FS	
H6BC	BP6FS	
H6D	BP6EFS	
H6DC	BP6EFS	
H6DCO	BP6EFS	
H6DP	BP6EFS	
H7CC	B6EFS	
H7CP	B6EFS	
H7D	BP6EFS	
H7DC	BP6EFS	
H7DCO	BP6EFS	
H7DCY	BP6EFS-13	
H7DP	BP6EFS	
H7DPY	BP6EFS-13	
H8B	BP5FS	
H8BC	BP5FS	
H8BP	BP5FS	
H8DC	BP5EFS	
H8DCO	BP5EFS	
H8DCX	BP5EFS-13	
H8DP	BP5EFS	
H9B	BP4FS	

Bic* = Best in class



BOSCH	→ NGK	Bic*/IX
H9BC	BP4FS	
H9BCY	BPR4FS-15	
H9DC	BP5EFS	
H9DCO	BP5EFS	
H9HP	BP5EFS	
HGR6KQC	BUR6EFSZ	
HGR7KQC	BUR6EFSZ	
HR10A	BR5FS	
HR10AC	BR5FS	
HR10ACY	BR5FS-15	
HR10AY	BR5FS-15	
HR10B	BPR4FS	
HR10BC	BPR4FS	
HR10BCX	BPR4FS-11	
HR10BCY	BPR4FS-15	
HR10BX	BPR4FS-11	
HR10BY	BPR4FS-15	
HR6B	BPR6FS	
HR6BP	BPR6FS	
HR6D	BPR6EFS	
HR6DC	BPR6EFS	
HR6DP	BPR6EFS	
HR6DS	BPR6EFS	
HR7DC	BPR6EFS	
HR7MPP	PTR5A-13	
HR8A	BR5FS	
HR8AC	BR5FS	
HR8ACY	BR5FS-15	
HR8AP	BR5FS	
HR8APY	BR5FS-15	
HR8AY	BR5FS-15	
HR8B	BPR5FS	
HR8BC	BPR5FS	
HR8BCY	BPR5FS-15	
HR8BP	BPR5FS	
HR8BPX	BPR5FS-11	
HR8BPY	BPR5FS-15	
HR8BY	BPR5FS-15	
HR8LCO	TR5-1/SR5	TR5-1IX
HR8LPO	TR5-1/SR5	TR5-1IX
HR9A	BR5FS	
HR9AC	BR5FS	
HR9ACY	BR5FS-15	
HR9AP	BR5FS	
HR9APY	BR5FS-15	
HR9AY	BR5FS-15	
HR9B	BPR4FS	
HR9BC	BPR4FS	
HR9BCY	BPR4FS-15	
HR9BPX	BPR4FS-11	
HR9BPY	BPR4FS-15	
HR9BY	BPR4FS-15	

BOSCH	→ NGK	Bic*/IX
HR9D	BPR5EFS	
HR9DC	BPR5EFS	
HR9DCX	BPR5EFS-13	
HS5E	BM7F	
HS8E	BM6F	
M10A	A6	
M10AC	A6	
M10ACO	A6	
M10AO	A6	
M12B	A6	
M145T1	A6	
M145T5	A6	
M175T1	A6	
M225P11S	A7	
M225T1	A7	
M240T1	A7	
M280T1	A8	
M45T1	A6	
M4A	A7	
M4A1	A8	
M4A2	A7	
M4AC	A7	
M5A	A7	
M5AC	A7	
M7A	A6	
M7AC	A7	
M8A	A6	
M8AC	A6	
M8AO	A6	
M95T1	A6	
M95T5	A6	
MA145T1	A5FS	
MA145T7	AP5FS	
MA145TR7	APR5FS	
MA175T1	A6FS	
MA175T7	AP6FS	
MA200T7	AP6FS	
UR2AS	CR8HS	CR8HIX
UR3AS	CR7HS	CR7HIX
UR4AS	CR6HS	CR6HIX
USR7AC	CMR6H	
VR8SEW	LZKAR7A	
W06AS	B10HVX	BR10HIX
W06CS	B11EGV	
W07AS	B10HVX	BR10HIX
W07CS	B10EGV	
W08AS	B9HVX	
W08CS	B10EGV	
W10A	B4H	
W10AC	B4H	
W10C	B4ES	
W10CC	B4ES	

Bic* = Best in class



BOSCH	→ NGK	Bic*/IX
W10D	BP4ES	
W10DC	BP4ES	
W10E	B4	
W10F	BP4	
W10FC	BP4	
W125T1	B4H	
W125T2	B4ES	
W125T3	B4	
W125T30	BP5ES	BPR5EIX
W125T4	B4H	
W125TR2	BR5ES	
W125TR3	BR6S	
W125TR30	BPR5ES	BPR5EIX
W12A	B4H	
W12E	B2	
W145T1	B5HS	
W145T1.1	B5HS	
W145T2	B5ES	
W145T3	B6S	
W145T30	BP5ES	BPR5EIX
W145T35	BP5HS	
W145TR2	BR5ES	
W145TR3	BR6S	
W145TR30	BPR5ES	BPR5EIX
W175T1	B6HS	BR6HIX
W175T2	B6ES	
W175T3	B6S	
W175T30	BP6ES	BPR6EIX
W175T35	BP6HS	BPR6HIX
W175T6	BP6S	
W175T7	BP6HS	BPR6HIX
W175TR1	BR6HS	BR6HIX
W175TR30	BPR6ES	BPR6EIX
W175Z1	B6HS	BR6HIX
W190M11S	B6HVX	BR6HIX
W200T27	BP6ES	BPR6EIX
W200T30	BP6ES	BPR6EIX
W200T35	BP6HS	BPR6HIX
W200TR30	BPR6ES	BPR6EIX
W215P21	BP7EVX / BPR7EIX	
W215T30	BP6ES	BPR6EIX
W225T1	B7HS	BR7HIX
W225T2	B7ES	
W225T3	B7S	
W225T30	BP8ES	
W225T35	BP7HS	BPR7HIX
W225T7	BPR7HS	BPR7HIX
W225TR30	BP7ES	BPR7EIX
W230T30	BP7ES	BPR7EIX
W235T28	BP8ES	
W240M1	B8HS	BR8HIX
W240MZ1	B8HS	BR8HIX

BOSCH	→ NGK	Bic*/IX
W240T1	B8HS	BR8HIX
W240T2	B8ES	BR8EIX
W240T28	B8ES	BR8EIX
W240T3	B7S	
W250P21	BP7ES	BPR7EIX
W250T1	B8HS	BR8HIX
W250T2	B8ES	BR8EIX
W255T30	BP7ES	BPR7EIX
W260M1	B8HS	BR8HIX
W260MZ1	B8HS	BR8HIX
W260MZ2	B9ES	BR9EIX
W260S1S	B8HVX	BR8HIX
W260S2S	B8EVX	BR8EIX
W260T1	B8HS	BR8HIX
W260T2	B9ES	BR9EIX
W260T20	B8ES	BR8EIX
W265P21	BPR9EVX	BPR9EIX
W275T1	B8HS	BR8HIX
W275T2	B9ES	BR9EIX
W280MZ1	B8HS	BR8HIX
W280MZ2	B9ES	BR9EIX
W280S1S	B9HVX	
W280S2S	B9EVX	BR9EIX
W280T30	BP8ES	
W2A	B9HS	
W2AC	B9HS	
W2AS	B9HVX	
W2C	B10ES	BR10EIX
W2CC	B10ES	BR10EIX
W2CO	B10ES	BR10EIX
W2CS	B10EVX	BR10EIX
W2D	BP9ES	
W300MZ2	B10ES	BR10EIX
W300T1	B9HS	
W300T2	B10ES	BR10EIX
W300T30	BP9ES	
W310S1S	B9HVX	
W310S2S	B10EVX	BR10EIX
W3A	B8HS	BR8HIX
W3AC	B8HS	BR8HIX
W3AO	B8HS	BR8HIX
W3AP	B8HS	BR8HIX
W3AS	B8HVX	BR8HIX
W3C	B9ES	BR9EIX
W3CC	B9ES	BR9EIX
W3CO	B9ES	BR9EIX
W3CP	B9ES	BR9EIX
W3CS	B9EVX	BR9EIX
W3D	BP8ES	
W3DP	BP8EVX	
W3DP2	BP8ES	
W3DPO	BP8EVX	

Bic* = Best in class



BOSCH	→	NGK	Bic*/IX
W45T1		B4H	
W4A		B8HS	BR8HIX
W4A1		B8HS	BR8HIX
W4A2		B8HS	BR8HIX
W4A5		B8HS	BR8HIX
W4AC		B8HS	BR8HIX
W4AP		B8HS	BR8HIX
W4AS		B8HVX	BR8HIX
W4C		B8ES	BR8EIX
W4C1		B8ES	BR8EIX
W4C2		B7ES	
W4C3		B7HS	BR7HIX
W4CC		B8ES	BR8EIX
W4CP		B8EVX	BR8EIX
W4CPX		B8ES-11	
W4CS		B8EVX	BR8EIX
W4DP		BP7EVX	BPR7EIX
W4DPO		BP8EVX / PFR7B	
W4E2		B7S	
W5A		B7HS	BR7HIX
W5AC		B7HS	BR7HIX
W5AP		B7HS	BR7HIX
W5AS		B7HVX	BR7HIX
W5B		BP7HS	BPR7HIX
W5BC		BP7HS	BPR7HIX
W5BP		BP7HS	BPR7HIX
W5C		B7ES	
W5CC		B7ES	
W5CCX		B7ES-11	
W5CP		B7ES	
W5CPX		B7ES-11	
W5CS		B7EVX	
W5D		BP7ES	BPR7EIX
W5D1		BP7ES	BPR7EIX
W5DC		BP7ES	BPR7EIX
W5DCO		BP7ES	BPR7EIX
W5DCX		BP7ES-11	
W5DP		BP7ES	BPR7EIX
W5DPO		BP7EVX	BPR7EIX
W5DPX		BP7ES-11	
W5DTC		BP6ET	PGR6D
W5E		B7S	
W5EC		B7S	
W5EP		B7S	
W6AS		B6HVX	BR6HIX
W6B		BP6HS	BPR6HIX
W6BC		BP6HS	BPR6HIX
W6BP		BP6HS	BPR6HIX
W6D		BP6ES	BPR6EIX
W6D1		BP6ES	BPR6EIX
W6DC		BP6ES	BPR6EIX
W6DC 0,8		BP6ES	BPR6EIX

BOSCH	→	NGK	Bic*/IX
W6DCO		BP6ES	BPR6EIX
W6DCO 0,8		BP6ESZ	PGR6D
W6DCX		BP6ES-11	BPR6EIX-11
W6DP		BP6EVX	BPR6EIX
W6DPO		BP6EVX	BPR6EIX
W6DPX		BP6EVX (1,1)	BPR6EIX
W6DTC		BP6ET	PGR6D
W7A		B6HS	BR6HIX
W7AC		B6HS	BR6HIX
W7AO		B6HS	BR6HIX
W7AP		B6HS	BR6HIX
W7B		BP6HS	BPR6HIX
W7BC		BP6HS	BPR6HIX
W7BP		BP6HS	BPR6HIX
W7C		B6ES	
W7CC		B6ES	
W7CCO		B6ES	
W7CCX		B6ES-11	
W7CP		B6ES	
W7CPX		B6ES-11	
W7CX		B6ES-11	
W7D		BP6ES	BPR6EIX
W7DO		BP6ES	BPR6EIX
W7DC		BP6ES	BPR6EIX
W7DCO		BP6ESZ	PGR6D
W7DCR		BPR6ES	BPR6EIX
W7DCX		BP6ES-11	BPR6EIX-11
W7DO		BP6ES	BPR6EIX
W7DP		BP6ES	BPR6EIX
W7DPX		BP6ES-11	BPR6EIX-11
W7DTC		BP6ET	PGR6D
W7DTC 1,0		BP6ET	PGR6D
W7DX		BP6ES-11	BPR6EIX-11
W7E		B6S	
W7EC		B6S	
W7EP		B6S	
W7F		BP6S	
W7FC		BP6S	
W7LTCR		BUR6ET	PGR6D
W8A		B5HS	
W8AC		B5HS	
W8AO		B5HS	
W8AP		B5HS	
W8B		BP5HS	
W8BC		BP5HS	
W8BP		BP5HS	
W8C		B5ES	
W8CC		B5ES	
W8CCX		B5ES-11	
W8CO		B5ES	
W8CP		B5ES	
W8D		BP5ES	BPR5EIX

Bic* = Best in class



BOSCH	→ NGK	Bic*/IX
W8DC	BP5ES	BPR5EIX
W8DCO	BP5ES	BPR5EIX
W8DCX	BP5ES-11	BPR5EIX-11
W8DCY	BP5ES-13	
W8DP	BP5ES	BPR5EIX
W8DPX	BP5ES-11	BPR5EIX-11
W8DTC	BP5ET	
W8DX	BP5ES-11	BPR5EIX-11
W8E	B6S	
W8EC	B6S	
W8F	BP5S	
W8FC	BP5S	
W8LCR	ZGR5A	
W8LDCR	BUR6ET	PGR6D
W8LPR	ZGR5A	
W8LTCR	BURSET/BPR5EKU	PGR6D
W8LTCR 1,0	BURSET-10	PGR6D
W8LTCREA	BURSET	
W95T1	B4H	
W95T2	B4ES	
W95T3	B4	
W95T30	BP4ES	
W95T6	BP4	
W9A	B4H	
W9AC	B5HS	
W9ACO	B5HS	
W9AO	B4H	
W9C	B4ES	
W9CC	B4ES	
W9D	BP5ES	BPR5EIX
W9DC	BP5ES	BPR5EIX
W9DCX	BP5ES-11	BPR5EIX-11
W9DP	BP5ES	BPR5EIX
W9DPX	BP5ES-11	BPR5EIX-11
W9DTC	BP5ET	
W9E	B4	
W9EC	B4	
W9ECO	B4LM	
W9EO	B4LM	
W9F	BP5S	
W9FC	BP5S	
W9LC	ZGR5A	
WA125TR30	BPR5EFS	
WA200T30	BP6EFS	
WA200TR30	BPR6EFS	
WA225T30	BP7EFS	
WAK145T3	BM6F	
WAK225T3	BM7F	
WEA	BUH	
WEC	BUE	
WET1	BUH	
WET2	BUE	

BOSCH	→ NGK	Bic*/IX
WG235T28	BP7ES	BPR7EIX
WG250P21	BPR9EVX	BPR9EIX
WG250T28	BP8EVX	
WG250T30	BP8ES	
WG265T2SP	BPR9EVX	BPR9EIX
WKA145T3	BM6A	
WKA145T6	BPM6A	
WKA175T3	BM6A	
WKA175T6	BPM6A	
WKA200TR6	BPMR6A	
WKA225T3	BM7A	
WKA225T6	BPM7A	
WQ6CS	B11EGV	
WR10A	BR4HS	
WR10AC	BR4HS	
WR10E	BR6S	
WR10F	BP4	
WR10FC	BP4	
WR10FCY	BPR4S-15	
WR10FY	BPR4S-15	
WR10LCV	BPR4ES-13	
WR11E0	BR4LM	
WR4AC	BR8HS	BR8HIX
WR4CC	BR8ES	BR8EIX
WR4CP	BR8EVX	BR8EIX
WR5A	BR7HS	BR7HIX
WR5AC	BR7HS	BR7HIX
WR5CC	BR7ES	
WR5CP	BR7ES	
WR5D	BPR7ES	BPR7EIX
WR5DC	BPR7ES	BPR7EIX
WR5DP	BPR7ES	BPR7EIX
WR5DS	BPR7EVX	BPR7EIX
WR6D	BPR6ES	BPR6EIX
WR6DC	BPR6ES	BPR6EIX
WR6DCX	BPR6ES-11	BPR6EIX-11
WR6DP	BPR6ES	BPR6EIX
WR6DPX	BPR6ES-11	BPR6EIX-11
WR6DS	BPR6EVX	BPR6EIX
WR6DTC	BP6ET	PGR6D
WR6DTC	BUR6ETB-10	
WR7A	BR6HS	BR6HIX
WR7AC	BR6HS	BR6HIX
WR7B	BPR6HS	BPR6HIX
WR7BC	BPR6HS	BPR6HIX
WR7BP	BPR6HS	BPR6HIX
WR7C	BR6ES	
WR7CC	BR6ES	
WR7CCX	BR6ES-11	
WR7CP	BR6ES	
WR7CPX	BR6ES-11	
WR7D	BPR6ES	BPR6EIX

Bic* = Best in class



BOSCH	→ NGK	Bic*/IX
WR7DC	BPR6ES	BPR6EIX
WR7DC2	BPR6ES	BPR6EIX
WR7DCX	BPR6ES-11	BPR6EIX-11
WR7DP	BPR6EVX	BPR6EIX
WR7DS	BPR6EVX	BPR6EIX
WR7F	BP6S	
WR7F	BPR6S	
WR8AC	BR5HS	
WR8C	BR5ES	
WR8CC	BR5ES	
WR8CP	BR5ES	
WR8D	BPR5ES	BPR5EIX
WR8DC	BPR5ES	BPR5EIX
WR8DCO	BPR5ES	BPR5EIX
WR8DCX	BPR5ES-11	BPR5EIX-11
WR8DP	BPR5ES	BPR5EIX
WR8DPX	BPR5ES-11	BPR5EIX-11
WR8DPY	BPR5ES-15	
WR8DS	BPR5EVX	BPR5EIX
WR8E	BR6S	
WR8EC	BR6S	
WR8EP	BR6S	
WR8F	BPR5S	
WR8F	BP5S	
WR8FC	BPR5S	
WR8FC	BP5S	
WR8FP	BP5S	
WR8FPY	BPR5S-15	
WR8HP	ZGR5C	
WR9AO	BR5HS	
WR9C	BR5ES	
WR9CC	BR5ES	
WR9D	BPR5ES	BPR5EIX
WR9DC	BPR5ES	BPR5EIX
WR9DCX	BPR5ES-11	BPR5EIX-11
WR9DCY	BPR5ES-15	
WR9DP	BPR5ES	BPR5EIX
WR9DPX	BPR5ES-11	BPR5EIX-11
WR9DS	BPR5EVX	BPR5EIX
WR9DY	BPR5ES-15	
WR9E	BR6S	
WR9EC	BR6S	
WR9ECO	BR6S / BM6	
WR9EO	BR6S	
WR9F	BP5S	
WR9F	BPR5S	
WR9FC	BP5S	
WR9FC	BPR5S	
WR9FCY	BPR5S-15	
WR9FP	BP5S	
WR9FPY	BPR5S-15	

BOSCH	→ NGK	Bic*/IX
WR9FY	BPR5S-15	
WR9HC	ZGR5C	
WR9HP	ZGR5C	
WR9LS	ZGR5A	
WS5E	BM7A	
WS5F	BPM7A	
WS7E	BM6A	
WS7F	BPM6A	
WS8E	BM6A	
WS8F	BPM6A	
WSR5F	BPMR7A	
WSR6F	BPMR7A	
WSR8F	BPMR6A	
WSR9E	BMR4A	
X3CPO	D9EA	DR9EIX
X4CS	D8EA	DR8EIX
X5DC	D7EA	
XR2AS	DR8HS	
XR2CS	DR8ES	DR8EIX
XR4AS	DR8HS	
XR4CS	DR8ES	DR8EIX
XR5DC	DR7EA	
Y6DC	---	
Y7MPP33	PLKR6A	
YR5DDE	KR9CI	
YR5LDE	DCPR8EK	
YR6LDE	BKR7EK	
YR7DE	DCPR8EN	DCPR8EIX
ZR8TPP15	LRF5B	

BRISK	→ NGK	Bic*/IX
B12YC	DP9EA-9	DPR9EIX-9
B14YC	DP8EA-9	DPR8EIX-9
B15YC	DP7EA-9	DPR7EIX-9
D12YC	BCP7ES	BCPR7EIX
D14Y	BKR6E	BKR6EIX
D14YC	BCP7ES	BCPR7EIX
D15Y	BKR6E	BKR6EIX
D15YC	BCP6ES	BCPR6EIX-11
D17Y	BKR5E	BKR5EIX
D17YC	BCP5ES	BCPR5EIX-11
DR12YC	BKR7E	BKR7EIX
DR12ZC-1	---	
DR14YC	BCPR7ES	BCPR7EIX
DR14ZC	ZFR7F-11	
DR14ZC-1	BCPR7ES-11	BCPR7EIX-11
DR15TC	BKUR5ET-10	
DR15YC	BKR6E	BKR6EIX
DR15Z	BKR6E	BKR6EIX
DR15Z-1	BCPR6ES-11	BCPR6EIX-11
DR17YC	BCPR5ES	BCPR5EIX-11
F14YC	AP7FS	



BRISK	→ NGK	Bic*/IX
F15YC	AP6FS	
FR14YC	APR6FS	
FR15YC	APR6FS	
G12YC	BP7EFS	
G14Y	BP7EFS	
G14YC	BP7EFS	
G15Y	BP6EFS	
G15YC	BP6EFS	
G17Y	BP5EFS	
G17YC	BP5EFS	
GR12YC	BPR7EFS	
GR14YC	BPR7EFS	
GR15YC	BPR6EFS	
GR17YC	BPR5EFS	
J17	B4LM	
J19	B2LM	
JR17	BR4LM	
JR19	BR2LM	
K15YC	BP6S	
K17C	B6S	
K17Y	BP5S	
K19	B4	
L08JW	B10EGV	
L08W	B11EGV	
L10JW	B8EGV	
L12W	B9EVX	BR9EIX
L12Y	BP9ES	
L12YC	BP9ES	
L14	B8ES	BR8EIX
L14C	B8ES	BR8EIX
L14Y	BP6ES	BPR6EIX
L14YC	BP7ES	BPR7EIX
L15	B7ES	
L15C	B7ES	
L15W	B8EVX	BR8EIX
L15Y	BP6ES	BPR6EIX
L15YC	BP6ES	BPR6EIX
L17	B6ES	
L17C	B6ES	
L17W	B7EVX	
L17Y	BP5ES	BPR5EIX
L17YC	BP5ES	BPR5EIX
L19	B4E	
L19C	B5ES	
LR12YC	BPR8ES	
LR12ZC	BPR8ES	
LR12ZC-1	---	
LR14TXS	BUR6ET	PGR6D
LR14YC	BPR7ES	BPR7EIX
LR14ZC	BPR7ES	BPR7EIX
LR14ZC-1	BPR7ES-11	
LR15TXS	BP5ET	

BRISK	→ NGK	Bic*/IX
LR15YC	BPR6ES	BPR6EIX
LR15Z	BPR6ES	BPR6EIX
LR15Z-1	BPR6ES-11	BPR6EIX-11
LR17YC	BPR5ES	BPR5EIX
N08W	B10HVX	BR10HIX
N12W	B9HVX	
N12Y	BP8HS	BPR8HIX
N12YC	BP8HS	BPR8HIX
N14	B8HS	BR8HIX
N14C	B9HS	
N14Y	BP6HS	BPR6HIX
N14YC	BP7HS	BPR7HIX
N15	B6HS	BR6HIX
N15C	B7HS	BR7HIX
N15W	B8HVX	BR8HIX
N15Y	BP6HS	BPR6HIX
N15YC	BP6HS	BPR6HIX
N17	B5HS	
N17C	B6HS	BR6HIX
N17W	B7HVX	BR7HIX
N17Y	BP4HS	
N17YC	BP5HS	
N19	B5HS	
N19C	B5HS	
NR12YC	BPR8HS	BPR8HIX
NR15YC	BPR6HS	BPR6HIX
P15	BM7A	
P15Y	BPM7A	
P17	BM6A	
P17Y	BPM6A	
PR15Y	BPMR7A	
PR17Y	BPMR6A	
U15	BM7F	
U17	BM6F	

CHAMPION	→ NGK	Bic*/IX
5828 / QL77JC4	BZ7HS-10	
5838 / QL78V	BUZHW-2	
5883 / QL78C	BR7HS	BR7HIX
5898 / QL76V	BZUHW	
5931 / RL82C	BR6HS	BR6HIX
5933 / L86CC	B6HS	BR6HIX
5939 / QL78YC	BPR7HS	BPR7HIX
5942 / RV15YC4	BPR4FS-11	
860	A6FS	
870	A5FS	
A10	D7EA	
A4HC	DP9EA-9	DPR9EIX-9
A50R	R2198-12P	
A50R	R2525-11	
A51R	R2525-10	
A51R	R2198-11P	



CHAMPION	→ NGK	Bic*/IX
A53C	R2525-11	
A53R	R2525-11	
A53R	R2198-10P	
A55C	R2525-10	
A55R	R2525-10	
A55V	R2270-11	
A57C	R2525-10	
A57G	R2525-10	
A57R	R2525-10	
A59C	R2525-9	
A59C	D9EA	DR9EIX
A59G	D9EVX	DR9EIX
A59G	R2525-9	
A59GC	R2430-9 (Ducati)	
A59GC	DCPR9EVX	DCPR9EIX
A5YC	DP9EA-9	DPR9EIX-9
A6	D8EA	DR8EIX
A61	D9EA	DR9EIX
A61G	D9EVX	DR9EIX
A6G	D8EVX	DR8EIX
A6GC	D8EVX	DR8EIX
A6HC	DP8EA-9	DPR8EIX-9
A6Y	DP8EA-9	DPR8EIX-9
A6YC	DP8EA-9	DPR8EIX-9
A8	D7EA	
A8Y	DP7EA-9	DPR7EIX-9
A8YC	DP7EA-9	DPR7EIX-9
BL11Y	BP5FS	
BL13Y	BP5FS	
BL4	B7FS	
BL5	B7FS	
BL6	B6FS	
BL7Y	BP7FS	
BL8	B6FS	
BL9Y	BP6FS	
BN12Y	BP5EFS	
BN2	B9EFS	
BN6Y	BP7EFS	
BN7Y	BP6EFS	
BN89Y	BP6EFS	
BN9Y	BP6EFS	
C10YCC	BCP5ES	BCPR5EIX-11
C10YCC	BCP6ES	BCPR6EIX-11
C11YCC	BCP5ES	BCPR5EIX-11
C281YC	BCP6ES	BCPR6EIX-11
C55	R7234-10	
C55 R	R7234-10	
C57	R7234-9	
C57C	R7234-9	
C59	R7234-9	
C59C	R7234-9	
C59YC	R5672A-9	

CHAMPION	→ NGK	Bic*/IX
C61	R7234-8	
C6BYC	BCP7ET	BCP7EVX
C6VPCY	BKR7EVX-11	BKR7EIX-11
C6YCC	BCP7ES	BCPR7EIX
C7Y	BCP7ES	BCPR7EIX
C7YC	BCP7ES	BCPR7EIX
C7YCC	BCP7ES	BCPR7EIX
C7YCX	BCP7ES	BCPR7EIX
C9MCC	ZFR5F	ZFR5FIX-11
C9Y	BCP6ES	BCPR6EIX-11
C9YC	BCP6ES	BCPR6EIX-11
C9YCC	BCP6ES	BCPR6EIX-11
C9YCX	BCP6ES	BCPR6EIX-11
CJ11	BM6A	
CJ14	BM4A	
CJ17LM	B4LM	
CJ3	BM7A	
CJ4	BM7A	
CJ6	BM7A	
CJ6Y	BPM7A	
CJ7Y	BPM7A	
CJ8	BM6A	
CJ86	BM6A	
CJ8Y	BPM6A	
D10	A6	
D14	A6	
D16	A6	
D16J	A6	
D21	A6	
D6	A8	
D9	A6	
D9J	A6	
DJ6J	BM7F	
DJ6Y	BPM7F	
DJ7J	BM6F	
DJ7Y	BPM6F	
DJ8J	BM6F	
F10	A6FS	
F10C	A6FS	
F11Y	AP5FS	
F11YC	AP5FS	
F14Y	AP5FS	
F62Y	AP8FS	
F7Y	AP7FS	
F7YC	AP7FS	
F7YCC	AP7FS	
F81Y	AP8FS	
F-82	A8F	
F83Y	AP8FS	
F9Y	AP6FS	
F9YC	AP6FS	
FN507Y	BCP7ES	BCPR7EIX

Bic* = Best in class



CHAMPION	→	NGK	Bic*/IX
G 56 R		R 016-10	
G 63 R		R 016-8	
G1		C9E	CR9EIX
G2		C8E	CR8EIX
G54V		R0045J-10	
G55		C9E	CR9EIX
G58		C9E	CR9EIX
G59C		C7E	CR7EIX
G61		C8E	CR8EIX
G63		C8E	CR8EIX
H03		B6S	
H10		B6L	
H10C		B6L	
H10J		B6L	
H11		B4L	
H12		B4L	
H8		B6L	
H8C		B6L	
H8J		B6L	
J10Y		BP6S	
J11		B4	
J11C		B4	
J11J		B4	
J11Y		BP5S	
J12J		B2	
J12Y		BP5S	
J12YC		BP5S	
J13Y		BP5S	
J14J		B2	
J14Y		BP5S	
J14YC		BP5S	
J17LM		B4LM	
J18Y		BP4	
J18YC		BP4	
J19LM		B2LM	
J2J		B9S	
J4		B7S	
J4C		B7S	
J4J		B7S	
J5		B7S	
J6		B6S	
J6C		B6S	
J6J		B6S	
J7		B6S	
J7J		B6S	
J8		B6S	
J8C		B6S	
J8J		B6S	
K13		A6	
K15J		A6	
K3G		A8	
K5G		A8	

CHAMPION	→	NGK	Bic*/IX
K7		A8	
K-8		A8	
K8G		A8	
K9		A7	
L10		B6HS	BR6HIX
L12Y		BP5HS	
L14		B4H	
L15Y		BP4HS	
L19V		BUH	
L20V		BUH	
L288		B5HS	
L2G		B9HVX	
L3G		B8HVX	BR8HIX
L4G		B7HVX	BR7HIX
L4J		B7HS	BR7HIX
L5		B7HS	BR7HIX
L55G		B10HVX	BR10HIX
L61Y		BP8HS	BPR8HIX
L64Y		BP7HS	BPR7HIX
L66Y		BP6HS	BPR6HIX
L6G		B7HVX	BR7HIX
L6VC		BU8H	
L76V		BUHW	
L77J		B7HS	BR7HIX
L77J4		B7HS-10	
L77JC		B7HS	BR7HIX
L77JC4		B7HS-10	
L77V		BUHW	
L78		B7HS	BR7HIX
L78C		B7HS	BR7HIX
L78V		BUHW-2	
L78YC		BP7HS-10	
L78YC6		BP8HS-15	
L7J		B6HS	BR6HIX
L81		B7HS	BR7HIX
L81Y		BP7HS	BPR7HIX
L82		B6HS	BR6HIX
L82C		B6HS	BR6HIX
L82Y		BP6HS	BPR6HIX
L82YC		BP6HS	BPR6HIX
L82YCC		BP6HS	BPR6HIX
L85		B6HS	BR6HIX
L85Y		BP6HS	BPR6HIX
L86		B6HS	BR6HIX
L86C		B6HS	BR6HIX
L86CC		B6HS	BR6HIX
L87Y		BP6HS	BPR6HIX
L87YC		BP6HS	BPR6HIX
L87YCC		BP6HS	BPR6HIX
L89CM		BP5HS	
L90		B5HS	
L90C		B5HS	

Bic* = Best in class



CHAMPION	→ NGK	Bic*/IX
L92LCC	BP5HA	
L92Y	BP5HS	
L92YC	BP5HS	
L95Y	BP4HS	
L9G	B6HVX	BR6HIX
L9J	B6HS	BR6HIX
N1	B10ES	BR10EIX
N10PY	BP6EVX	BPR6EIX
N10Y	BP6ES	BPR6EIX
N10Y4	BP6ES-11	BPR6EIX-11
N11Y	BP5ES	BPR5EIX
N11YC	BP5ES	BPR5EIX
N11YC4	BP5ES-11	BPR5EIX-11
N11YCC	BP5ES	BPR5EIX
N12Y	BP5ES	BPR5EIX
N12YC	BP5ES	BPR5EIX
N12YCC	BP5ES	BPR5EIX
N13L	ZGR5C	
N13Y	BP5ES	BPR5EIX
N14LY	ZGR5C	
N14Y	BP5ES	BPR5EIX
N16Y	BP4ES	
N16YC	BP4ES	
N178B	B8EM	
N180B	B7EM	
N19V	BUE	
N1C	B10ES	BR10EIX
N2	B9ES	BR9EIX
N21	B4ES	
N279YC	BP7ES	BPR7EIX
N281YC	BP6ES	BPR6EIX
N288	B5ES	
N2C	B9ES	BR9EIX
N2G	B9EVX	BR9EIX
N3	B8ES	BR8EIX
N3C	B8ES	BR8EIX
N3G	B8EVX	BR8EIX
N4	B7ES	
N4C	B7ES	
N4G	B7EVX	
N4YC	BP9ES	
N5	B6ES	
N52R	---	
N54R	B10EG	
N55G	B10SEGV	
N56R	B10SEGP	
N57	B10ES	BR10EIX
N57G	B10SEGV	
N57R	B10EG	
N59G	B9SEGV	
N5C	B6ES	
N5G	B6EVX	

CHAMPION	→ NGK	Bic*/IX
N6	B6ES	
N60	B9ES	BR9EIX
N60R	B8EG	
N60Y	BPR10EVX	
N62R	B8EG	
N63Y	BP9ES	
N64Y	BP8ES	
N65Y	BP7ES	BPR7EIX
N66Y	BP6ES	BPR6EIX
N6BYC	BP6ET	PGR6D
N6GY	BP8EVX	
N6Y	BP8ES	
N6YC	BP8ES	
N6YCC	BP8ES	
N7	B7ES	
N74C	BUR6EB-11/B6EB-11	
N79Y	BP6ES	BPR6EIX
N7BMC	BP6ET	PGR6D
N7BYC	BP6ET	PGR6D
N7GY	BP7EVX	BPR7EIX
N7Y	BP7ES	BPR7EIX
N7YC	BP7ES	BPR7EIX
N7YCC	BP7ES	BPR7EIX
N7YCX	BP7ES	BPR7EIX
N8	B6ES	
N80	B10EG	
N80G	B11EGV	
N82	B10EG	
N82G	B10SEGV	
N84	B9EG	
N84G	B9SEGV	
N86	B9EG	
N86G	B9EGV	
N87	B8EG	
N87G	B8EGV	
N8GY	BP6EVX	BPR6EIX
N8L	ZGR5C	
N8Y	BP6ES	BPR6EIX
N9BMC	BPR5EIKU	PGR6D
N9BYC	BP6ET	PGR6D
N9BYC4	BP5ET-10	
N9Y	BP6ES	BPR6EIX
N9YC	BP6ES	BPR6EIX
N9YC4	BP6ES-11	BPR6EIX-11
N9YCC	BP6ES	BPR6EIX
N9YCX	BP6ES	BPR6EIX
OBL9Y	BPR6FS	
OE001/r04	BP6ES	BPR6EIX
OE001/t10	BP6ES	BPR6EIX
OE002/r04	BKR6E	BKR6EIX
OE002/t10	BKR6E	BKR6EIX
OE003/T10	BCP6ES	BCPR6EIX-11

Bic* = Best in class



CHAMPION	→ NGK	Bic*/IX
OE004/r04	BPR6ES	BPR6EIX
OE004/r04	GR5	
OE004/t10	GR5	
OE004/t10	BPR6ES	BPR6EIX
OE005/r04	BKR6E	BKR6EIX
OE005/t10	BKR6E	BKR6EIX
OE006/r04	GR5	
OE006/r04	BPR6ES	BPR6EIX
OE006/t10	BPR6ES	BPR6EIX
OE006/t10	GR5	
OE007/T10	BP6HS	BPR6HIX
OE008/r04	BPR7ES	BPR7EIX
OE008/t10	BPR7ES	BPR7EIX
OE009/r04	BP7EFS	
OE009/t10	BP7EFS	
OE010/r04	BP7ES	BPR7EIX
OE010/t10	BP7ES	BPR7EIX
OE011/R04	BPR6EFS	
OE011/T10	BPR6EFS	
OE012/r04	BP6ET	PGR6D
OE012/t10	BP6ET	PGR6D
OE013/t10	BKR5ES	BKR5EIX
OE014/r04	BCPR7ES	BCPR7EIX
OE014/t10	BCPR7ES	BCPR7EIX
OE015/t10	BP5ES	BPR5EIX
OE016/r04	BKR6E	BKR6EIX
OE016/t10	BKR6E	BKR6EIX
OE017/T10	BCP7ES	BCPR7EIX
OE018/r04	BPR7ES	BPR7EIX
OE018/t10	BPR7ES	BPR7EIX
OE019/r04	BKR5EK	BKR5EIX
OE019/t10	BKR5EK	BKR5EIX
OE020/R04	BPR6EFS	
OE020/t10	BPR6EFS	
OE021/r04	BCPR6ET	
OE021/t10	BCPR6ET	
OE023/R04	BCP6ES	BCPR6EIX-11
OE023/T10	BCP6ES	BCPR6EIX-11
OE025/r04	BUR6ET	PGR6D
OE025/t10	BUR6ET	PGR6D
OE026/r04	BKR6EK	BKR6EQUP
OE026/t10	BKR6EK	BKR6EQUP
OE027/r04	BURSET-10	PGR6D
OE027/T10	BURSET-10	PGR6D
OE028/r04	BP5ET-10	
OE028/t10	BP5ET-10	
OE030/t10	BKR6EKC	BKR6EIX
OE031/r04	PTR5A-13	
OE031/t10	PTR5A-13	
OE032/r04	BUR6ET-10	
OE032/r04	BKJR6ET-10	PFR6Q
OE032/t10	BUR6ET-10	

CHAMPION	→ NGK	Bic*/IX
OE032/t10	BKUR6ET-10	PFR6Q
OE033/t10	PFR6G-9	
OE033/t10	BKR6EZ	
OE034/t10	BKR6ES	BKR6EIX
OE035/t10	LFR5B	
OE036/r04	BP7EFS	
OE036/t110	BP7EFS	
OE037/T10	B6HS	BR6HIX
OE038/T10	BP6HS	BPR6HIX
OE039/t10	BCPR6ES-11	BCPR6EIX-11
OE040/t10	B9ES	BR9EIX
OE041/t10	ZFR5F	ZFR5FIX-11
OE042/t10	BPR5ES	BPR5EIX
OE043/r04	BCPR7ES	BCPR7EIX
OE043/t10	BCPR7ES	BCPR7EIX
OE044/t10	BP6ET	PGR6D
OE045/t10	BPR5ES	BPR5EIX
OE048/r04	BPR6ES-11	BPR6EIX-11
OE048/t10	BPR6ES-11	BPR6EIX-11
OE049/t10	BPR5ES-11	BPR5EIX-11
OE050/r04	BP7EFS	
OE050/t10	BP7EFS	
OE051/t10	BPR5ES	BPR5EIX
OE054/t10	APR6FS	
OE056/r04	BKR7ES-11	BKR7EIX-11
OE056/t10	BKR7ES-11	BKR7EIX-11
OE057/T10	BCP5ES	BCPR5EIX-11
OE058/T10	BCP7ES	BCPR7EIX
OE059/t10	BP5HS	
OE060/t10	ZGR5B	
OE063/t10	BCPR6ES-11	BCPR6EIX-11
OE064/r04	BPR6HS	BPR6HIX
OE064/T10	BPR6HS	BPR6HIX
OE065/T10	BP5ES	BPR5EIX
OE066/r04	ZFR6F	
OE066/t10	ZFR6F	
OE067/t10	BP7EFS	
OE068/t10	B8ES	BR8EIX
OE072/t10	BPR5EFS	
OE073/t10	DCPR9E	DCPR9EIX
OE074/t10	B6ES	
OE075/t10	BCP7ES	BCPR7EIX
OE076/T10	BCP7ET	BCP7EVX
OE077/t10	BCPR6ET	
OE078/t10	B8EVX	BR8EIX
OE079/t10	B7ES	
OE080/t10	BKR7ES-11	BKR7EIX-11
OE083/t10	DCPR8E	DCPR8EIX
OE083/t10	DPR8EA-9	DPR8EIX-9
OE084/R04	BP8ES	
OE084/t10	BP8ES	
OE085/t10	BKR5EKU	

Bic* = Best in class



CHAMPION	→ NGK	Bic*/IX
OE086/t10	BR6HS	BR6HIX
OE087/r04	BP8ES	
OE087/t10	BP8ES	
OE090/t10	BP7EFS	
OE091/t10	BR9ES	BR9EIX
OE092/t10	CR9E	CR9EIX
OE093/t10	BKR5EZ	
OE095/r04	BP6ET	PGR6D
OE095/t10	BP6ET	PGR6D
OE098/t10	BR7ES	
OE099/t10	BPR5EFS	
OE100/t10	BPR5EKU	PGR6D
OE103/T10	R2430-9 (Ducati)	
OE103/t10	DCPR9EVX	DCPR9EIX
OE105/t10	GR4	GR4IX
OE108/T10	BR8ES	BR8EIX
OE109/t10	BP6ET	PGR6D
OE110/t10	BCPR7ES	BCPR7EIX
OE112/T10	D8EVX	DR8EIX
OE116/t10	BPR8ES	
OE122/t10	PMR8A	
OE124/t10	PFR5J-11	
OE124/t10	PFR5G	
OE125/t10	B9EVX	BR9EIX
OE129/T10	BKR7EVX-11	BKR7EIX-11
OE130/t10	LZKAR7A	
OE132/T10	DP8EA-9	DPR8EIX-9
OE134/t10	PFR5J-11	
OE136/t10	PFR6J-11	
OE141/t10	BKR6EVX 0,8	
OE143/t10	PFR6G-9	
OE144/t10	BKJUR6ET-10	PFR6Q
OE145/t10	BKJUR6ET-10	PFR6Q
OE146/t10	PFR5G-13E	
OE151/T06	BPR5EFS	
OE151/T06	TR4	
OE152/t10	BKR5E-11	BKR5EIX-11
OE155/t10	APR6FS	
OE156/t10	ZGR5C	
OE160/t06	ZFR4F-11	
OE161/t04	GR4	GR4IX
OE162/t06	BR6ES	
OE163/t04	LZTR4A-11	
OE165/T04	R7234-9	
OE166/T04	C7E	CR7EIX
OE169/t04	R5724-9	
OE171/t04	BPR6FS	
OE171/t04	UR6	
OE173/T04	R2525-10	
OE175/t10	LFRA5AP-11	
QJ11Y	BP6S	
QJ12Y	BP5S	

CHAMPION	→ NGK	Bic*/IX
OJ13Y	BP5S	
ON11Y	BPR5ES	BPR5EIX
ON12Y	BPR5ES	BPR5EIX
ON3	BR8ES	BR8EIX
P10Y	D6HA	
P7	D8HA	
P7G	DR8HS	
P8Y	D6HA	
PG2PHP	PMR8A	
PG4PHP	PMR7A	
PZ7HC	C7HSA	CR7HIX
QC12PEP	PZFR6H	
QC12YC	BKR5ES	BKR5EIX
QC59YC	BKR8E	
QL16V	BUZ8H	
QL6VC	BU8H	
QL76V	BUZH	
QL77CC	BR8HS	BR8HIX
QL77J4	BZ7HS-10	
QL77JC4	BZ7HS-10	
QL78C	BR7HS	BR7HIX
QL78V	BUZH-2	
QL78YC	BPR7HS	BPR7HIX
QL7J5	BR6HS	BR6HIX
QL81Y	BPZ7HS-10	
QL82C	BR6HS	BR6HIX
QL82YC	BPR6HS	BPR6HIX
QL86	BR6HS	BR6HIX
QL87YC	BPR6HS	BPR6HIX
QL92LCC	BP8HS-10	
QN2	BR9ES	BR9EIX
QN2C	BR9ES	BR9EIX
QN2G	BR9EVX	BR9EIX
QN3	BR8ES	BR8EIX
QN3C	BR8ES	BR8EIX
QN84	BR9EG	
QN86	BR8EG	
R10	D6EA	
R44CXLS	BPR5ES	BPR5EIX
R54G	R 217-11	
R6	D8EA	DR8EIX
R6G	D8EVX	DR8EIX
R8	D7EA	
RA2HC	DPR9EA-9	DPR9EIX-9
RA4HC	DPR9EA-9	DPR9EIX-9
RA4HC	DCPR9E	DCPR9EIX
RA4HCC	DCPR8E	DCPR8EIX
RA59GC	DCPR9EVX	DCPR9EIX
RA59PP	D9EVX	DR9EIX
RA6	DR8ESL	DR8EIX
RA6HC	DPR8EA-9	DPR8EIX-9
RA6HC	DCPR8E	DCPR8EIX

Bic* = Best in class



CHAMPION	→ NGK	Bic*/IX
RA6Y	DPR8EA-9	DPR8EIX-9
RA6YC	DPR8EA-9	DPR8EIX-9
RA8HC	DCPR7E	DCPR7EIX
RA8Y	DPR7EA-9	DPR7EIX-9
RA8YC	DPR7EA-9	DPR7EIX-9
RBL11Y	BPR5FS	
RBL11Y6	BPR5FS-15	
RBL12	BR5FS	
RBL12-6	BR5FS-15	
RBL13Y	BPR5FS	
RBL13Y6	BPR5FS-15	
RBL15Y	BPR4FS	
RBL15Y4	BPR4FS-11	
RBL15Y6	BPR4FS-15	
RBL16Y	BPR4FS	
RBL17Y	BPR4FS	
RBL17Y6	BPR4FS-15	
RBL8	BR6FS	
RBL8-6	BR6FS-15	
RBL9Y	BPR6FS	
RBN12Y	BPR5EFS	
RBN13Y	BPR5EFS	
RBN14Y	BPR5EFS	
RBN9Y	BPR6EFS	
RC10DMC	BKR5EK	BKR5EIX
RC10ECC	ZFR6F-11	ZFR6FIX-11
RC10PYC	BKR6EVX 0,8	
RC10PYP4	PFR5G	
RC10PYP4	PFR5J-11	
RC10VTC4	BPR5EKJP	
RC10YC4	BCPR6ES-11	BCPR6EIX-11
RC10YCC	BKR6E	BKR6EIX
RC11LCC4	BRE527Y-11	
RC12LYC	ZFR5F	ZFR5FIX-11
RC12MC4	PZFR5F-11	
RC12MC5	ZFR5F-11	ZFR5FIX-11
RC12PYP	PFR5J-11	
RC12YC	BKR5ES	BKR5EIX
RC12YC5	FR45	
RC14YC	BKR5ES	BKR5EIX
RC14YC4	BKR5E-11	BKR5EIX-11
RC6VPYC	BKR7EVX-11	BKR7EIX-11
RC6YC	BCPR7ES	BCPR7EIX
RC7BMC	BCPR6ET	
RC7BYC4	BCPR6ET	
RC7GYC	BKR7EVX-11	BKR7EIX-11
RC7Y	BCPR7ES	BCPR7EIX
RC7YC	BCPR7ES	BCPR7EIX
RC7YC4	BKR7ES-11	BKR7EIX-11
RC7YCC	BCPR7ES	BCPR7EIX
RC7YCC4	BKR7ES-11	BKR7EIX-11
RC87PYC	BKUR6ET-10	PFR6Q

CHAMPION	→ NGK	Bic*/IX
RC87YCL	PFR6G-9	
RC87YCL	BKR6EZ	
RC89PYC	BKUR5ET-10	
RC89YCC	BKR5EZ	
RC8BYC	BKR6EKC	BKR6EIX
RC8DMC	BKR6EK	BKR6EQUP
RC8PYCB	PFR6G-9	
RC8PYP	PFR6J-11	
RC8PYPB4	PFR5G-13E	
RC8PYX	FR7KDC	
RC8VTC4	BKUR5ET	
RC8YC4	BKR5E-11	BKR5EIX-11
RC8YCL	BKR6ES	BKR6EIX
RC9BMC	BKR5EKU	
RC9MC4	ZFR5F-11	ZFR5FIX-11
RC9MCC	ZFR6F	
RC9Y	BKR6E	BKR6EIX
RC9YC	BKR6E	BKR6EIX
RC9YC4	BCPR6ES-11	BCPR6EIX-11
RC9YCC	BKR6E	BKR6EIX
RCJ4	BMR7A	
RCJ6	BMR7A	
RCJ6Y	BPMR7A	
RCJ7Y	BPMR7A	
RCJ8	BMR6A	
RCJ8Y	BPMR6A	
RD14	A6	
RD16	A6	
RD16J	A6	
RD9	A6	
RDJ6J	BM7F	
RDJ7J	BMR6F	
RDJ7Y	BPMR6F	
RDJ8J	BMR6F	
RE10LC	SR5	
RE14MCC5	LZTR4A-11	
RE14PLP5	PLZTR5a-13	
RE7PYC5	PTR5A-13	
RE7YCC	PTR5A-13	
RE8MCL	LZKAR7A	
RE8MCL	LZKAR7A	
REC10PYC4	LFR5AP-11	
REC14PYC	LFR4AP-11	
REC9YCL	LFR5B	
RES9YCC4	PTR5A-13	
RF10	AR6FS	
RF10C	AR6FS	
RF11Y	APR6FS	
RF11YC	WR5	
RF11YC	APR6FS	
RF12-5	AR5FS-11	
RF14Y	APR5FS	

Bic* = Best in class



CHAMPION	→ NGK	Bic*/IX
RF7YC	APR6FS	
RF7YCC	APR6FS	
RF9Y	APR6FS	
RF9Y5	APR6FS	
RF9YC	WR5	
RF9YC	APR6FS	
RFN14LY	ZFR4F-11	
RG2PHP	CR8EVX	CR8EIX
RG4HC	CR9E	CR9EIX
RG4PHP	PMR7A	
RG4PHP	PMR8A	
RG6YC	CR8EB	CR8EIX
RG6YCH	CPR8E	
RG94C	CR8E	CR8EIX
RH10C	B6L	
RH10C	B6L	
RH8C	---	
RJ10Y	BP6S	
RJ11	BR6S	
RJ11Y	BP5S	
RJ12C	BR6S	
RJ12Y	BP5S	
RJ12YC	XR5	
RJ12YC	BP5S	
RJ14CC	XR4	
RJ14Y	BP5S	
RJ14YC	BP5S	
RJ14YC	XR4	
RJ14YC	XR4	
RJ17LM	BR4LM	
RJ18Y	BP4	
RJ18YC	XR4	
RJ18YC	BP4	
RJ19LM	BR2LM	
RJ20Y	BP4	
RJ6	BR6S	
RJ6C	BR6S	
RJ6J	BR6S	
RJ7	BR6S	
RJ8	BR6S	
RJ8C	BR6S	
RJ8J	BR6S	
RL12Y	BPR6HS	BPR6HIX
RL19	BR5HS	
RL4J	BR7HS	BR7HIX
RL77J	BR7HS	BR7HIX
RL78	BR7HS	BR7HIX
RL78C	BR7HS	BR7HIX
RL7J	BR6HS	BR6HIX
RL82	BR6HS	BR6HIX
RL82C	BR6HS	BR6HIX
RL82Y	BPR6HS	BPR6HIX

CHAMPION	→ NGK	Bic*/IX
RL82YC	BPR6HS	BPR6HIX
RL82YCC	BPR6HS	BPR6HIX
RL85	BR6HS	BR6HIX
RL85G	---	
RL86	BR6HS	BR6HIX
RL86C	BR6HS	BR6HIX
RL87Y	BPR6HS	BPR6HIX
RL87YC	BPR6HS	BPR6HIX
RL90	BR5HS	
RL95YC	BPR5HS	
RN10GY	BPR6EVX	BPR6EIX
RN10VTC	BUR5ET	PGR6D
RN10VTC4	BUR5ET-10	PGR6D
RN10Y	BPR6ES	BPR6EIX
RN10Y4	BPR6ES-11	BPR6EIX-11
RN11Y	BPR5ES	BPR5EIX
RN11YC	BPR5ES	BPR5EIX
RN11YC4	BPR5ES-11	BPR5EIX-11
RN11YCC	BPR5ES	BPR5EIX
RN12GY	BPR5EVX	BPR5EIX
RN12MC4	BPR4EY-11	
RN12Y	BPR5ES	BPR5EIX
RN12YC	BPR5ES	BPR5EIX
RN12YC4	BPR5ES-11	BPR5EIX-11
RN12YC6	BPR5ES-13	
RN12YCC	BPR5ES	BPR5EIX
RN13L	ZGR5C	
RN13LYC	ZGR5C	
RN14LY	ZGR5C	
RN14MC5	BPR4EY-11	
RN14PMP5	GR4	GR4IX
RN14Y	BPR5ES	BPR5EIX
RN14Y6	BPR5ES-13	
RN14YC	GR4	GR4IX
RN16Y	BPR4ES	
RN16YC5	BPR4ES-13	
RN180B	BR7EM	
RN1C	BR10ES	BR10EIX
RN2	BR9ES	BR9EIX
RN2C	BR9ES	BR9EIX
RN2G	BR9EVX	BR9EIX
RN3	BR8ES	BR8EIX
RN3C	BR8ES	BR8EIX
RN3G	BR8EVX	BR8EIX
RN4	BR7ES	
RN49G	---	
RN4C	BR7ES	
RN5	BR6ES	
RN57YC	BR10EG	
RN5C	BR6ES	
RN6	BR6ES	
RN6Y	BPR8ES	

Bic* = Best in class



CHAMPION	→ NGK	Bic*/IX
RN6YC	BPR6ES	
RN74C	BR6EB-11	
RN79G	---	
RN7GY	BPR7EVX	BPR7EIX
RN7Y	BPR7ES	BPR7EIX
RN7YC	BPR7ES	BPR7EIX
RN7YCC	BPR7ES	BPR7EIX
RN7YCC4	BPR7ES-11	
RN8	BR5ES	
RN8L	ZGR5C	
RN8VTYC4	BUR6ET	PGR6D
RN9GY	BPR6EVX	BPR6EIX
RN9LCC	---	
RN9LCC	ZGR5B	
RN9Y	BPR6ES	BPR6EIX
RN9YC	BPR6ES	BPR6EIX
RN9YC	GR5	
RN9YC4	BPR6ES-11	BPR6EIX-11
RN9YCC	BPR6ES	BPR6EIX
RN9YCC	GR5	
RP10HC	DR5HS	
RP7	DR8HS	
RS10LC	TR5-1	TR5-1IX
RS12YC	BPR5EFS	
RS12YC	TR4	
RS12YC6	BPR5EFS-13	
RS13LYC	TR4-2	
RS14LC	TR5-1	TR5-1IX
RS14LYC	TR4-2	
RS14YC	BPR5EFS	
RS15LYC	TR4-2	
RS17YX	TR4	TR4IX
RS5C	BR7EFS	
RS7YC	BPR7EFS	
RS9YC	BPR6EFS	
RS9YCC	BPR6EFS	
RV12C	BR5FS	
RV12C6	BR5FS-15	
RV12YC	BPR5FS	
RV12YC	UR5	UR5IX
RV12YC6	BPR5FS-15	
RV15YC	BPR4FS	
RV15YC4	UR4	UR4IX
RV15YC4	BPR4FS-11	
RV15YC6	BPR4FS-15	
RV17YC	BPR4FS	
RV17YC6	BPR4FS-15	
RV8C	BR6FS	
RV8C6	BR6FS-15	
RV91MC	BR6FS	
RV92YC	BPR5FS	
RV9YC	UR6	

CHAMPION	→ NGK	Bic*/IX
RV9YC	BPR6FS	
RZ7C	CMR7H	
RZN12Y	BPR5EFS	
RZN12Y5	BPR5EFS	
S10YCC	BP5EFS	
S12YC	BP5EFS	
S279YC	BP6EFS	
S281YC	BP6EFS	
S379YC	BP7EFS	
S59C	R5724-9	
S6YC	BP7EFS	
S7YC	BP7EFS	
S7YCC	BP7EFS	
S9YC	BP6EFS	
S9YCC	BP6EFS	
UD16	A6	
UJ12	B2	
UJ2J	B8S	
UJ4J	B7S	
UJ6	B6S	
UJ8	B6S	
UJ81C	B7S	
UJ81J	B7S	
UK10	A6	
UL17V	BUHXW-1	
UL18V	BUHX	
UL4J	B7HS	BR7HIX
UL77V	BUHXW-1	
UL81C	B7HS	BR7HIX
UL81J	B7HS	BR7HIX
UN19V	BUE	
UN79Y	BP6ES	BPR6EIX
UY6	---	
V12YC	BP5FS	
V4C	B7FS	
V63C	R5673-7	
V9YC	BP6FS	
W16Y	---	
XC12PEPB	PZFR6H	
XJ10Y	BP6S	
Y82	CM6	
Z10	C6HSA	CR6HIX
Z10G	C7HVX	CR7HIX
Z12	C6HSA	CR6HIX
Z6	C8HSA	CR8HIX
Z7G	C7HVX	CR7HIX
Z8	C7HSA	CR7HIX
Z9Y	C7HSA	CR7HIX
DENSO	→ NGK	Bic*/IX
9807B-5615P	ZFR6K-11	
9807B-5615W	IZFR6K-11	

Bic* = Best in class



DENSO	→ NGK	Bic*/IX
J16AR-U11	BRE527Y-11	
J16A-U11	BE527Y-11	
J16AY	BP5EJ	
J16AYR	BPR5EJ	
J16BR-U	BRE529Y	
J16B-U11	BE529Y-11	
J16CRU	ZGR5A	
K14PRU-11	BKR4E-11	
K14P-U11	BKR5E-11	BKR5EIX-11
K16PRP11	BKR5EVX	
K16PR-U	BKR5E	BKR5EIX
K16PR-U11	BKR5E-11	BKR5EIX-11
K16R-U	BKR5EYA	
K16R-U11	BKR5EYA-11	
K16TNRS9	BKR5EKC	
K16TR-11	BKR5EKB-11	
K20DTR-S11	ZFR6G	
K20HR-U11	LFRR6C-11	
K20PBR-S10	BKUR6ET-10	PFR6Q
K20PR-L11	BKR6EN-11	
K20PR-TP11	BKR6EVX-11	
K20PR-U	BKR6E	BKR6EIX
K20PR-U11	BKR6E-11	BKR6EIX-11
K20P-U	BK6E	
K20P-U11	BK6E-11	
K20R-U	BKR6EYA	
K20R-U11	BKR6EY-11	BKR6EIX-11
K20TMR11	BKR6EKC-N-11	
K20TNR-S	BKUR6EK	
K20TR-11	BKR6EKB-11	
K20TRX	BKR6EKU	
K22PB	BCP7ET	BCP7EVX
K22PR-L11	BKR7EN-11	
K22PR-U	BKR7E	BKR7EIX
K22PR-U11	BKR7E-11	BKR7EIX-11
K22P-U11	BK7E-11	
K22TM11	BK7EK-N-11	
K22TMR	BKR7EKC-N	
K22TMR11	BKR7EKC-N-11	
K22TNR-S	BKUR7EK	
K29A-Z	R7117-10	
KJ16CR-L11	ZFR5F-11 / ZFR5J-11	ZFR5FIX-11
KJ16CR-L11	ZFR5J-11	
KJ206CR-L11	ZFR6F-11	ZFR6FIX-11
KJ20CR-L11	ZFR6F-11/ZFR6J-11	ZFR6FIX-11
KJ20DR-M11	ZFR6K-11	
KJ20DR-M11	ZFR6K-11	
KJ22CR-L11	ZFR7F-11 / ZFR7J-11	
KJ22CRL8	ZFR7F	
L14-U	A6	
M17	A6	
M22	A7	

DENSO	→ NGK	Bic*/IX
M24S	A8	
MA14P-U	AP5FS	
MA16PR-U	APR5FS	
MA16PR-U11	APR5FS	
MA16PR-U15	APR5FS	
MA16P-U	AP5FS	
MA17P-U	AP6FS	
MA20PR-U	APR6FS	
MA20P-U	AP6FS	
MA20R-U	AR6FS	
MA20R-U11	AR6FS	
MA9P-U	AP4FS	
P16R	BPR5EP-11	
P16R-13	BPR5EP-13	
P20PR11	PGR6A-11	
P20R8	BPR6EP-8	
PK16PR11	PFR5B-11	
PK16PR-P11	PFR5J-11	
PK16R11	BKR5EP-11	
PK16R-8	BKR5EP-8	
PK16TR11	BKR5EKP-11	
PK20R8	BKR6EPA-8	
PK20PR11	PFR6B-11	
PK20PR-L11	PFR6G-11	
PK20PR-P	PFR6J	
PK20PR-P11	PFR6J-11	
PK20PR-TP	PFR6M	
PK20R11	BKR6EP-11	
PK20R-13	PFR6G-13	
PK20R-13	BKR6EP-13	
PK20R8	BKR6EP-8	
PK20R-P8	BKR6EP-N-8	
PK20TR11	BKR6EKP-11	
PK22PR11	PFR7B-11	
PK22PR-L11	PZFR6F-11	
PK22PR-L11	PFR7G-11	
PK22PR-L11	PFR7G-11	
PK22PR-TP	PFR7M	
PKJ16CR8	PZFR5F	
PKJ16CR-L11	PZFR5F-11	
PKJ20CR8	PZFR6F	
PKJ20CR-L11	PZFR6F-11	
PQ16R	BCPR5EP-11	
PQ16R13	BCPR5EP-13	
PQ16R8	BCPR5EP-8	
PQ20R	BCPR6EP-11	
PQ20R13	BCPR6EP-13	
PQ20R8	BCPR6EP-8	
PQ20R-P11	BCPR6EP-N-11	
PQ20R-P8	BCPR6EP-N-8	
Pq20RP-8	BCPR6EPN-8	
PT16EPRL13	PTR5D-10	

Bic* = Best in class



DENSO	→ NGK	Bic*/IX
PT16VR-13	PTR5A-13	
Q14R-U11	BCPR4EY-11	
Q16PR-U	BCPR5E	
Q16PR-U11	BCPR5EY-11	BCPR5EIX-11
Q16P-U11	BCP5EY-11	BCPR5EIX-11
Q16RU	BCPR5EY	BCPR5EIX-11
Q16RU-11	BCPR5EY-11	BCPR5EIX-11
Q16-U	BCP5EY	BCPR5EIX-11
Q20PR-P11	BCPR6EVX-11	
Q20PR-U	BKR6E	BKR6EIX
Q20PR-U11	BCPR6EY-11	
Q20P-U	BCP6ES	BCPR6EIX-11
Q20P-U11	BCP6E-11	BCPR6EIX-11
Q20R-U	BCPR6EY	
Q20R-U11	BCPR6EY-11	
Q22PR-U	BCPR7ES	BCPR7EIX
Q22PR-U11	BCPR7ES-11	BCPR7EIX-11
Q22P-U	BCP7ES	BCPR7EIX
Q22P-U11	BCP7ES-11	BCPR7EIX-11
Q27A-Z	R7232-9	
QJ16AR-U	BCRE527Y	
QJ20CR-11	ZFR6A-11	
S27	SD9A	
S29	SD10A	
S29A	SD10A	
SD29A	SD10A	
SF-10	BUHX	
SF-50	BUHW	
SF-51	BUHW-2	
SK16PR-E11	IFR5E-11/ BKR5EIX-11P	
SK16PR-L11	IFR5G-11K	
SK16RP8	IFR5T-8N	
SK20BR11	IFR6A-11T	
SK20R-11	IFR6T-11	
SK20R-11	IFR6A11	
SK22PR-M11	IFR7G-11K	
SKJ20DRM11	IZFR6K11	
SKJ20DR-M11	IZFR6K-11	
SVK20R-Z8	BKR6EP-8	
T14PR-U	BPR4FS	
T14PR-U15	BPR4FS-15	
T16EPR-U	BPR5EFS	
T16EX-U	BP5EFS	
T16PR-U	BPR5FS	
T16PR-U11	BPR5FS-11	
T16PR-U15	BPR5FS-15	
T16P-U	BP5FS	
T16R-U	BR5FS	
T16R-U15	BR5FS-15	
T20EPR-U	BPR6EFS	
T20EP-U	BP6EFS	
T20EX-U	BP6EFS	

DENSO	→ NGK	Bic*/IX
T20MP-U	BPM6F	
T20M-U	BM6F	
T20PR-U	BPR6FS	
T20PR-U11	BPR6FS-11	
T20PR-U15	BPR6FS	
T20P-U	BP6FS	
T20R-U	BR6FS	
T22EP-U	BP7EFS	
T22MP-U	BPM7F	
T22M-U	BM7F	
TR20	B6HS	BR6HIX
TR22	B7HS	BR7HIX
TR22-10	B7HS-10	
TR24	B8HS	BR8HIX
TR24-10	B8HS-10	
U14FSRUB	CR4HSB	
U16FS-L	C5HSA	CR5HIX
U16FSR-L	CR5HSA	CR5HIX
U16FSR-U	CR5HSA	CR5HIX
U16FSR-UB	CR5HSB	CR5HIX
U16FS-U	C5HSA	CR5HIX
U16FS-UB	C5HSB	CR5HIX
U17F	C5HSA	CR5HIX
U20FS	C6HSA	CR6HIX
U20FS-L	C6HSA	CR6HIX
U20FSR-U	CR6HSA	CR6HIX
U20FS-U	C6HSA	CR6HIX
U20M-U	CM6	
U22ESR-N	CR7E	CR7EIX
U22FS	C7HSA	CR7HIX
U22FS-GU	C7HVX	CR7HIX
U22FS-L	C7HSA	CR7HIX
U22FSR-L	CR7HS	CR7HIX
U22FS-U	C7HSA	CR7HIX
U24ES-N	C8E	CR8EIX
U24ESR-N	CR8E	CR8EIX
U24ETR	CR8EK	
U24FE9	C8EH-9	CR8EHIX-9
U24FER9	CR8EH-9	CR8EHIX-9
U24FS	C8HSA	CR8HIX
U24FS-C	L8A	
U24FS-L	C8HSA	CR8HIX
U24FSR-C	LR8A	
U24FSR-U	CR8HS	CR8HIX
U24FS-U	C8HSA	CR8HIX
U27ES-N	C9E	CR9EIX
U27ESR-N	CR9E	CR9EIX
U27ETR	CR9EK	
U27FE9	C9EH-9	CR9EHIX-9
U27FER-9	CR9EH-9	CR9EHIX-9
U31ESR-N	CR10E	
U31ETR	CR10EK	

Bic* = Best in class



DENSO	→ NGK	Bic*/IX
VUH27D	IMR9C-9H	
W14	B4	
W14E	B4ES	
W14EPR-U	BPR4ES	
W14EP-U	BP4ES	
W14EXR-U	BPR5EA	
W14EXR-U	BPR4EY	
W14EXR-U11	BPR4EY-11	
W14EX-U	BP4EY	
W14EX-U11	BP4EY-11	
W14F	B4H	
W14FP	BP4H	
W14FP-L	BP4HS	
W14FPR	BPR4H	
W14FPR-L	BPR4HS	
W14FPR-UL	BPR4HS	
W14FPR-UL10	BPR4HS-10	
W14FP-U	BP4H	
W14FP-UL	BP4HS	
W14FP-UL10	BP4HS-10	
W14FR-U	BR4HS	
W14F-U	B4H	
W14F-U10	B4H-10	
W14L	B4L	
W14LMR-US	BR4LM	
W14LM-U	B4LM	
W14LM-US	B4LM	
W14MPR-U10	BPMR4A	
W14MP-U10	BPM4A-10	
W14MR-U	BMR4A	
W14M-U	BM4A	
W14M-US	BM4A	
W14P	BP5S	
W14PR-U	BP4	
W14-U	B4	
W14-US	B4	
W16EKR-S11	BUR5EB-11	
W16EK-S11	BUR5EB-11/BU5EB-11	
W16EP-GU	BP5EVX	BPR5EIX
W16EPR-S11	BR5EA-11	
W16EPR-U	BPR5ES	BPR5EIX
W16EPR-U11	BPR5ES-11	BPR5EIX-11
W16EPU	BP5ES	BPR5EIX
W16EP-U	BP5ES	BPR5EIX
W16EP-U10	BP5ES-11	BPR5EIX-11
W16EP-ZU	BP5EVX	BPR5EIX
W16ES	B5ES	
W16ES-L	BR5ES/BR5EB	
W16ES-L11	BUR5EB-11/BR5EB-11	
W16ESR-U	BR5ES	
W16ES-U	B5ES	
W16ETR-S	BPR5EKA	

DENSO	→ NGK	Bic*/IX
W16ET-S	BP5EKA	
W16EXR-U	BPR5EY	BPR5EIX
W16EXR-U11	BPR5EY-11	BPR5EIX-11
W16EXU	BP5EY	BPR5EIX
W16EX-U	BP5EAL	
W16EX-U11	BP5EA-L-11	
W16EX-U13	BP5ES-13	
W16FP	BP5HS	
W16FP-L	BP5HA	
W16FPR	BPR5HS	
W16FPR-U	BPR5HS	
W16FP-U	BP5HS	
W16FP-U10	BP5HS-10	
W16FP-UL	BP5HA	
W16FS	B5HS	
W16FSR	BR5HS	
W16FS-U	B5HS	
W16LS	B6L	
W16PR-U	BPR5S	
W16P-U	BP5S	
W17P	BP6S	
W17PR-U	BP6S	
W20DTR-S	BKR6EKB	
W20DTR-SA	BPR6EKB-L	
W20EA	B6EM	
W20EAR	BR6EM	
W20EKR-S11	BUR6EB-11	
W20EK-S11	BUR6EB-11/BU6EB-11	
W20EP	B6ES	
W20EPB	BP6ET	PGR6D
W20EPBRS	BUR6ET	PGR6D
W20EP-GU	BP6EVX	BPR6EIX
W20EPRS-11	BUR6EA-11	
W20EPR-U	BPR6ES	BPR6EIX
W20EPR-U10	BPR6ES-11	BPR6EIX-11
W20EPR-U11	BPR6ES-11	BPR6EIX-11
W20EP-S11	BU6EA-11	
W20EP-U	BP6ES	BPR6EIX
W20EP-U11	BP6ES-11	BPR6EIX-11
W20EP-ZU	BP6EVX	BPR6EIX
W20ES	B6ES	
W20ES-GU	B6EVX	
W20ES-L	BR6ES/B6EB	
W20ES-L11	BUR6EB-11/B6EB-11	
W20ESR	BR6ES	
W20ESR-L	BR6ES/BR6EB	
W20ESR-L11	BUR6EB-11/BR6EB-11	
W20ES-U	B6ES	
W20ES-U11	B6ES-11	
W20ES-ZU	B6EVX	
W20ET	BP6EK	
W20ET-L	BP6EKN	

Bic* = Best in class



DENSO	→ NGK	Bic*/IX
W20ETR-L	BPR6EKN	
W20ETR-S	BPR6EK-A	
W20ET-S	BP6EK-A	
W20EXR-U	BPR6EY	BPR6EIX
W20EXR-U11	BPR6EY-11	BPR6EIX-11
W20EX-U	BP6EY	
W20EX-U11	BP6EY-11	
W20EX-U13	BP6ES-13	
W20FP	BP6HS	BPR6HIX
W20FP-L	BP6HSA	BPR6HIX
W20FPR	BPR6HS	BPR6HIX
W20FPR-U	BPR6HS	BPR6HIX
W20FP-U	BP6HS	BPR6HIX
W20FP-U10	BP6HS-10	
W20FS	B6HS	BR6HIX
W20FS-GU	B6HVX	BR6HIX
W20FSR	BR6HS	BR6HIX
W20FSR-U	BR6HS	BR6HIX
W20FS-U	B6HS	BR6HIX
W20FS-ZU	B6HVX	BR6HIX
W20M	BM6A	
W20MP-U	BPM6A	
W20MP-U10	BPM6A-10	
W20MR-U	BMR6A	
W20M-U	BM6A	
W20M-US	BM6A	
W20S	B6S	
W20SR-U	BR6S	
W20S-U	B6S	
W21ES-L11	BR6EB-L-11/B6EB-L-11	
W21ESR-L11	BR6EB-L-11	
W22EA	B7EM	
W22EAR	BR7EM	
W22EB	BR7ET/B7ET	
W22EBR	BR7ET	
W22EDR	BR7EQ	
W22EDR14	BR7EQ-14	
W22EK-S11	BUR7EB-11/BU7EB-11	
W22EP	BP7ES	BPR7EIX
W22EP11	BP7ES-11	
W22EP-GU	BP7EVX	BPR7EIX
W22EPR-U	BPR7ES	BPR7EIX
W22EP-S11	BU7EA-11	
W22EP-U	BP7ES	BPR7EIX
W22EP-ZU	BP7EVX	BPR7EIX
W22ES	B7ES	
W22ES-GU	B7EVX	
W22ES-L	B7EB	
W22ES-L11	B7EB-11	
W22ESR	BR7ES	
W22ESR-L	BR7EB	
W22ESR-L11	BR7EB-11	

DENSO	→ NGK	Bic*/IX
W22ESR-U	BR7ES	
W22ES-U	B7ES	
W22ES-U11	B7ES-11	
W22ES-ZU	B7EVX	
W22FP	BP7HS	BPR7HIX
W22FPR-U	BPR7HS	BPR7HIX
W22FP-U	BP7HS	BPR7HIX
W22FP-U10	BP7HS-10	
W22FS	B7HS	BR7HIX
W22FS-GU	B7HVX	BR7HIX
W22FSR	BR7HS	BR7HIX
W22FS-U	B7HS	BR7HIX
W22FS-ZU	B7HVX	BR7HIX
W22M	BM7A	
W22MP-U	BPM7A	
W22MP-US	BPM7A	
W22M-U	BM7A	
W22M-US	BM7A	
W22S	B7S	
W22S-U	B7S	
W24EP	BP8ES	
W24EP-11	BP8ES	
W24EP-U	BP8ES	
W24ES	B8ES	BR8EIX
W24ES-GU	B8EVX	BR8EIX
W24ESR	BR8ES	BR8EIX
W24ESR-U	BR8ES	BR8EIX
W24ES-U	B8ES	BR8EIX
W24ES-U11	B8ES-11	
W24ES-V	B8EG	
W24ES-ZU	B8EGV	
W24FP-L	BP8HSA	BPR8HIX
W24FP-U	BP8HS	BPR8HIX
W24FS	B8HS	BR8HIX
W24FS-GU	B8HVX	BR8HIX
W24FSR	BR8HS	BR8HIX
W24FS-U	B8HS	BR8HIX
W24FS-U10	B8HS-10	
W24FS-ZU	B8HVX	BR8HIX
W24S	B8S	
W24S-U	B8S	
W25EA	B8EM	
W25EAR	BR8EM	
W25EB	BR8ET/BB8ET	
W25EBR	BR8ET	
W25EDR	BR8EQ	
W25EDR14	BR8EQ-14	
W25EN	B8EG	
W25EPT	B8EGP	
W25FC	B8HCS	
W25FN	B8HVX	BR8HIX
W27EBR	BR9ET	

Bic* = Best in class



DENSO	→ NGK	Bic*/IX
W27EDR14	BR9EQ-14	
W27EMR-C	BR9ECM	
W27EN	B9EG	
W27EPT	B9EGP	
W27ES	B9ES	BR9EIX
W27ES-GU	B9EVX	BR9EIX
W27ESR	BR9ES	BR9EIX
W27ES-U	B9ES	BR9EIX
W27ES-V	B9EG	
W27ES-ZU	B9EGV	
W27FC	B9HCS	
W27FS	B9HS	
W27FS-GU	B9HVX	
W27FSR	BR9HS	
W27FS-U	B9HS	
W27FS-U10	B9HS-10	
W27FS-ZU	B9HVX	
W27S	B9S	
W27S-U	B9S	
W29EPT	B95EGP	
W29ES-GU	B95EGV	
W29ES-ZU	B95EGV	
W31EN	B10EG	
W31EPT	B10EGP	
W31ES	B10ES	BR10EIX
W31ES-GU	B10EVX	BR10EIX
W31ES-U	B10ES	BR10EIX
W31ES-ZU	B10EGV	
W31FS	B10HS	BR10HIX
W31FS-GU	B10HVX	BR10HIX
W31FS-ZU	B10HVX	BR10HIX
W32EPT	B105EGP	
W34ES-ZU	B11EGV	
W9	B2	
W9EP	BP2E	
W9EXR-U	BPR2ES	
W9EX-U	BP2E	
W9FP	BP2H	
W9FP-L	BP2HS	
W9FP-UL	BP2HS	
W9LMR-US	BR2LM	
W9LM-US	B2LM	
W9P	BP4	
W9-U	B2	
WA20M	BM6F	
WA20M-U	BM6F	
WA22M	BM7F	
WA22M-U	BM7F	
X16FSR-U	DR5HS	
X20EPR-GL	PJR6A	
X20FS-GU	D6HVX	
X20FSR-U	DR6HS	

DENSO	→ NGK	Bic*/IX
X20FS-U	D6HA	
X22EPR-GL	PJR7A	
X22EPR-U9	DPR7EA-9	DPR7EIX-9
X22EP-U9	DP7EA-9	DPR7EIX-9
X22ES-GU	D7EVX	
X22ESR-U	DR7ES	
X22ES-U	D7EA	
X24EPR-GL	PJR8A	
X24EPR-U9	DPR8EA-9	DPR8EIX-9
X24EP-U9	DP8EA-9	DPR8EIX-9
X24ES-GU	D8EVX	DR8EIX
X24ESR-U	DR8ESL	DR8EIX
X24ES-U	D8EA	DR8EIX
X24FSR-U	DR8HS	
X24FS-U	D8HA	
X24GPR-U	DPR8Z	
X24GP-U	DP8Z	
X27EPR-U9	DPR9EA-9	DPR9EIX-9
X27EP-U9	DP9EA-9	DPR9EIX-9
X27ESR-U	DR8ES	DR8EIX
X27ES-U	D9EA	DR9EIX
X27GPR-U	DPR9Z	
X27GP-U	DP9Z	
X31ES-U	D10EA	
XE20HRU9	LZKAR7A	
XU20EPR-U	DCPR6E	
XU20EP-U	DCP6E	
XU22EPR-U	DCPR7E	DCPR7EIX
XU22EPR-ZU	DCPR7EVX	DCPR7EIX
XU22EP-U	DCP7E	
XU22EP-ZU	DCP7EVX	
XU24EPR-U	DCPR8E	DCPR8EIX
XU24EPR-ZU	DCPR8EVX	DCPR8EIX
XU24EP-U	DCP8E	
XU24EP-ZU	DCP8EVX	
Y27FER	ER9EH	
Z20ES-U	D6EA	

EYQUEM	→ NGK	Bic*/IX
1000	B8HS	BR8HIX
1000 MOTO	B8HS	BR8HIX
1000CM	B7S	
1000L	B8ES	BR8EIX
1000L MOTO	B8HS	BR8HIX
1000M	B8HS	BR8HIX
100M	B8HS	BR8HIX
1100	B9HS	
1100L	B8ES	BR8EIX
1100L MOTO	B8ES	BR8EIX
1150L	B9ES	BR9EIX
200	B4H	
202CT	B2LM	

Bic* = Best in class



EYQUEM	→ NGK	Bic*/IX
300AM	B4L	
30AM	B4L	
400J	BR5FS	
406	BP6HS	BPR6HIX
450JS	BPR4FS-15	
450L	B5ES	
480CS	BP5S	
500AM	B6L	
500C	B6S	
500CJT	BM6F	
500CM	B6S	
500CS	BP5S	
500CT	BM6A	
500J	BR6FS	
500JS	BPR4FS	
500M	B5HS	
502 MOTO	B4H	
502CT	B4LM	
505JS	BP5FS	
50AM	B-6L	
50M	B5HS	
520CS	BP5S	
550CS	BP5S	
550JS	BPR5FS	
550LS	BP5ES	BPR5EIX
550S	BP4HS	
580LS	BP5ES	BPR5EIX
580S	BP4HS	
600CS	BP5S	
600JS	BPR6FS	
600L	B6ES	
600LS	BP6ES	BPR6EIX
600S	BP5HS	
700	B6HS	BR6HIX
700 MOTO	B6HS	BR6HIX
700CM	B6S	
700CTS	BPM6A	
705JS	BP7FS	
705L	B6ES	
705L MOTO	B6ES	
705S	BP6HS	BPR6HIX
705S MOBY MOTO	B5HS	
707LS	BP6ES	BPR6EIX
70M	B6HS	BR6HIX
750	BP6HS	BPR6HIX
750L	B6ES	
750LJS	BP6EFS	
750LS	BP6ES	BPR6EIX
753LJS	BP6EFS	
755	B6HS	BR6HIX
755 MOTO	B6HS	BR6HIX
755CJT	BM7F	

EYQUEM	→ NGK	Bic*/IX
755CM	B6S	
755CT	BM7A	
755L	B6ES	
755L MOTO	B6ES	
755LJS	BP6EFS	
755LS	BP6ES	BPR6EIX
755LS MOTO	BP6ES	BPR6EIX
755M	B6HS	BR6HIX
755S	BP6HS	BPR6HIX
75LM	B6ES	
75M	B6HS	BR6HIX
775SX	BP6HS	BPR6HIX
775X	B6HS	BR6HIX
800L	B6ES	
800LJS	BP6EFS	
800LS	BP6ES	BPR6EIX
800LS MOTO	BP6ES	BPR6EIX
802L	B6ES	
803LJS	BP6EFS	
805L	B6ES	
805L MOTO	B6ES	
805LJS	BP7EFS	
805LJSP	BP7EFVX	
805LP	B8EVX	BR8EIX
850	B7HS	BR7HIX
850 MOTO	B7HS	BR7HIX
850LS	BP7ES	BPR7EIX
883LJP	B8EFS	
C32	B5HS	
C32LS	BP5ES	BPR5EIX
C32S	BP5HS	
C42LJS3	BP6EFS	
C42S	BP6HS	BPR6HIX
C52LS	BP5ES	BPR5EIX
C62	B7HS	BR7HIX
C62LJS	BP6EF	
C62LJS	BP6EFS	
C62LS	BP6E	BPR6EIX
C62LS	BP6ES	BPR6EIX
C62LS3X	BP5ET	
C62S	BP7HS	BPR7HIX
C72LJS	BP7EFS	
C72LS	BP7ES	BPR7EIX
C72LS3X	BP6ET	PGR6D
C82LJS	BP7EFS	
C82LS	BP7ES	BPR7EIX
C82LS3X	BP7ET	
C92LS	BP8ES	
D1000	D8HA	
D1000 MOTO	D8HA	
D1000L	D9EA	DR9EIX
D1050L	D9EA	DR9EIX

Bic* = Best in class



EYQUEM	→ NGK	Bic*/IX
D755 MOTO	D6HA	
D775	D6HA	
D800L	D7EA	
D800L MOTO	D7EA	
D900L	D8EA	DR8EIX
FC42LS	BCP5ES	BCPR5EIX-11
FC52LS	BCP5ES	BCPR5EIX-11
FC52LS	BCP5E	BCPR5EIX-11
FC58LS	BCP6ES	BCPR6EIX-11
FC62LS	BCP6ES	BCPR6EIX-11
FC62LS2	BCP6ES	BCPR6EIX-11
FC62LS3	BCP6ET	BCPR6EIX-11
FC62LS3X	BCP6ET	BCPR6EIX-11
FC72LS	BCP7ES	BCPR7EIX
FC82LS	BCP7E	BCPR7EIX
FC82LS1	BCP7ES	BCPR7EIX
FC82LS2	BCP7ES	BCPR7EIX
FN52LS	BK5ESZ	
K200M	A6	
K300J	A5FS	
K300JS	AP5FS	
K300M	A6	
K350JS	AP5FS	
K450JS	AP5FS	
K500M	A6	
K550JS	AP6FS	
K600M	A6	
K750M	A7	
KC62JS	AP6FS	
R1000	BR8HS	BR8HIX
R1000L	BR8ES	BR8EIX
R850	BR7HS	BR7HIX
RC32LS5	BPR4ES-11	
RC42S	BPR6HS	BPR6HIX
RC52LS	BPR5EA	
RC52LS5	BPR5EA-11	
RC52LZ3EX	BUR5ET	PGR6D
RC52LZE	ZGR5A	
RC58LZ3EX	BUR6ET	PGR6D
RC62HJSDP	PTR5A-13	
RC62LJS	BPR6EFS	
RC62LS	BPR6ES	BPR6EIX
RC62LS5	BPR6ES-11	BPR6EIX-11
RC62S	BPR7HS	BPR7HIX
RC82LS	BPR7ES	BPR7EIX
RC82LS5	BPR7EY-11	
RFC42LS	BCPR5ES	BCPR5EIX-11
RFC42LZ2E	BKR5EK	BKR5EIX
RFC50LZ2E	BKR5EK	BKR5EIX
RFC52LS	BCPR5ES	BCPR5EIX-11
RFC52LS3	BCPR5ET	
RFC52LS5	BCPR5ES-11	BCPR5EIX-11

EYQUEM	→ NGK	Bic*/IX
RFC52LS5	BKR5E-11	BKR5EIX-11
RFC52LSP	BKR6EK	
RFC52LZE	ZFR5F	ZFR5FIX-11
RFC52LZK	BKR5EZ	
RFC57LS3	BCPR6ET	
RFC58LS	BKR6E	BKR6EIX
RFC58LS2E	BKR6EK	BKR6EQUP
RFC58LS3	BCPR6ET	
RFC58LS5	BKR6ES-11	BKR6EIX-11
RFC58LS5	BCPR6ES-11	BCPR6EIX-11
RFC58LSP	BKR6EZ	
RFC58LZ	BKR6EY	BKR6EIX
RFC58LZ2	BKR6EKC	BKR6EIX
RFC58LZ2E	BKR5EZ	
RFC58LZ3EX	BKUR6ET	PF6RQ
RFC58LZ5	BKR6EY-11	BKR6EIX-11
RFC58LZ5E	ZFR6F-11	ZFR6FIX-11
RFC62LS3X	BCPR6ET	
RFC62LS5	BCPR6ES-11	BCPR6EIX-11
RFC62LZ3X	BKUR7ET	PF7RQ
RFC82LS	BCPR7ES	BCPR7EIX
RFC82LS5	BCPR7ES-11	BCPR7EIX-11
RFN52HZ	LF6R5B	
RFN58HZ	LF6R6B	
RFN58LZ	BKR6EK	
T850	C7HSA	CR7HIX
XXC62JS	APR6FS	

HARLEY-DAVIDSON	→ NGK	Bic*/IX
3	B6L	
3-4	BP5S	
4	B6L	
4-5	BP7HS	BPR7HIX
4R	B6L	
4R5	BPR7HS-10	
5	B6S	
5A6	BP5EY	BPR5EIX
5R6	BPR5EY	BPR5EIX
5R6A	BPR5EY-11	BPR5EIX-11
5RL	ZGR5C	
6R12	DPR7EA-9	DPR7EIX-9
8	B10EGV	

HONDA	→ NGK	Bic*/IX
12290-PHM-003	ILZFR6A11(A)	
12290-PNE-0030	ZFR6K-11	
12290-PPD-003	ILZFR6AT-S	
12290-PRB-A01	IFR7G-11K	
12291-PHM-003	ILZFR6A11(B)	
12292-PHM-003	ILZFR6A11(C)	
12293-PHM-003	ILZFR6A11(D)	

Bic* = Best in class



HONDA	→ NGK	Bic*/IX
31911-HW1-671	IMR9D-9H	
31911-KRN-731	R0409B-8	
31911-KSK-731	BR9EG-N-8	
31911-mbt-f21	IJR8B9	
31911-MBW-E11	IMR8C-9H	
31911-MBW-E11	IMR8C-9H	
31911-mcw-003	IMR8B-9H	
31912-KRN-731	R0409B-9	
31912-MBW-E11	IMR9C-9H	
31912-MCW-0030	IMR9B-9H	
31912-MEE-671	IMR9C-9HE	
31912-MEE-J01	IMR8C-9HES	
31912-MEL-003	IMR9C-9HES	
31914-Z0H-003	CMR4H	
31914-Z0H-801	CM4H	
31914-Z0H-003	CMR4H	
31915-Z0H-003	CMR5H	
31915-Z0H-801	CM5H	
31915-Z0H-003	CMR5H	
31916-Z0H-003	CMR6H	
31916-Z0H-801	CM6H	
31916-Z0H-003	CMR6H	
31916-ZY3-003	IZFR6F11	
31918-MEB-671	IFR8H11	
31919-MEB-671	IFR9H11	
31988-GEV-761	ER8EH-N	
31989-GEV-761	ER9EH-N	
94701-00408	CR9EIA-9	
98049-58716	ER8EH	
98049-59716	ER9EH	
98049-60716	ER10EH	
98052-56471	CM6	
98056-54717	C4HA	
98056-54718	CR4HSA	
98056-54770	C4HSB	
98056-55713	C5HSA	CR5HIX
98056-55717	C5HA	
98056-55718	CR5HSA	CR5HIX
98056-55770	C5HSB	CR5HIX
98056-55777	CR5HSB	CR5HIX
98056-56713	C6HSA	CR6HIX
98056-56716	CR6HS	CR6HIX
98056-56717	C6HA	
98056-56718	CR6HSA	CR6HIX
98056-57713	C7HSA	CR7HIX
98056-57716	CR7HS	
98056-57717	C7HA	
98056-57718	CR7HSA	CR7HIX
98056-57918	CR7HSA-9	
98056-58713	C8HSA	CR8HIX
98056-58716	CR8HS	CR8HIX
98056-58717	C8HA	

HONDA	→ NGK	Bic*/IX
98056-58718	CR8HSA	CR8HIX
98059-55916	CR5EH-9	
98059-56916	CR6EH-9	
98059-57910	C7EH-9	
98059-57916	CR7EH-9	
98059-58910	C8EH-9	CR8EHIX-9
98059-58916	CR8EH-9	CR8EHIX-9
98059-5891F	CR8EHVX-9	
98059-5891U	IMR8A-9H	
98059-589J6	CR8EH-9S	
98059-59910	C9EH-9	CR9EHIX-9
98059-59916	CR9EH-9	
98059-5991F	CR9EHVX-9	
98059-5991U	IMR9A-9H	
98059-599J6	CR9EH-9S	
98059-599U	CR9EHI-9	
98059-60916	CR10EH-9	
98061-57611	DP7Z	
98061-57616	DPR7Z	
98061-58611	DP8Z	
98061-58616	DPR8Z	
98061-59611	DP9Z	
98061-59616	DPR9Z	
98066-54710	D4H	
98066-54716	DR4HS	
98066-55710	D5HS	
98066-55716	DR5HS	
98066-55740	D5HS	
98066-56710	D6HS	
98066-56716	DR6HS	
98066-56717	D6HA	
98066-58714	D8HS	
98066-58716	DR8HS	
98066-58717	D8HA	
98066-60710	D10HS	
98069-38716	DR8ESL	DR8EIX
98069-55911	DP5EA-9	
98069-55916	DPR5EA-9	
98069-56716	DR6ES	
98069-56717	D6EA	
98069-56718	DR6EA	
98069-56911	DP6EA-9	
98069-56916	DPR6EA-9	
98069-5691U	IJR6A9	
98069-569Q7	DCPR6E	
98069-57716	DR7ES	
98069-57717	D7EA	
98069-57719	DR7ES	
98069-5771P	DR7EA	
98069-57726	DR7EA	
98069-57911	DP7EA-9	DPR7EIX-9
98069-57912	DPR7EVX-9	DPR7EIX-9

Bic* = Best in class



HONDA	→ NGK	Bic*/IX
98069-57916	DDR7EA-9	DDR7EIX-9
98069-5791U	IJR7A9	
98069-5791U	IJR7A9	
98069-5797Q	DCPR7E	DCPR7EIX
98069-58716	DR8ES	DR8EIX
98069-58717	D8EA	DR8EIX
98069-58719	DR8ES	DR8EIX
98069-5871P	DR8EA	
98069-58911	DP8EA-9	DDR8EIX-9
98069-58912	DDR8EVX-9	DDR8EIX-9
98069-58916	DDR8EA-9	DDR8EIX-9
98069-5891F	DDR8EVX-9	DDR8EIX-9
98069-59717	D9EA	DR9EIX
98069-59911	DP9EA-9	DDR9EIX-9
98069-59912	DDR9EVX-9	DDR9EIX-9
98069-59916	DDR9EA-9	DDR9EIX-9
98069-5991F	DDR9EVX-9	DDR9EIX-9
98069-60711	D10ES	
98069-60717	D10EA	
98069-63410	D13E	
98073-52710	B2	
98073-54710	B4	
98073-54740	BM4A	
98073-54744	BMR4A	
98073-54771	BPM4A	
98073-54776	BPMR4A	
98073-54941	BPM4A-10	
98073-54944	BPMR4A-10	
98073-56740	BM6A	
98073-56741	BPM6A	
98073-56744	BMR6A	
98073-56941	BPM6A-10	
98073-56944	BPMR6A-10	
98076-52711	BP2HS	
98076-52716	BPR2HS	
98076-52717	BPR2HS	
98076-52719	BP2HS	
98076-5401G	BR4HSA-10	
98076-54112	BP4HK	
98076-54710	B4H	
98076-54711	BP4HS	
98076-54713	BP4HSA	
98076-54715	BPR4HSA	
98076-54716	BR4HS	
98076-54717	BPR4HS	
98076-54719	BP4HS	
98076-5471G	BR4HSA	
98076-54746	BR4HS	
98076-54747	BPR4HS	
98076-54770	B4H	
98076-54911	BP4HS-10	
98076-54914	BPR4HS-10	

HONDA	→ NGK	Bic*/IX
98076-54917	BPR4HS-10	
98076-54919	BP4HS-10	
98076-5491G	BR4HSA-9	
98076-54944	BPR4HS-10	
98076-54947	BPR4HS-10	
98076-55711	BP5HS	
98076-55716	BR5HS	
98076-55717	BPR5HS	
98076-55719	BP5HS	
98076-55747	BPR5HS	
98076-5601G	BR6HSA-10	
98076-56112	BP6HK	
98076-56710	B6HS	BR6HIX
98076-56711	B6HS	BR6HIX
98076-56713	BP6HSA	
98076-56715	BPR6HSA	
98076-56716	BR6HS	BR6HIX
98076-56717	BPR6HS	BPR6HIX
98076-56719	BP6HS	BPR6HIX
98076-5671G	BR6HSA	BR6HIX
98076-5671M	B6HSA	
98076-56740	B6HS	BR6HIX
98076-56741	B6HS	BR6HIX
98076-56747	BPR6HS	BPR6HIX
98076-56917	BPR6HS-10	
98076-5691G	BR6HSA-9	
98076-57710	B7HS	BR7HIX
98076-57711	BP7HS	BPR7HIX
98076-57716	BR7HS	BR7HIX
98076-57717	BPR7HS	BPR7HIX
98076-57719	BP7HS	BPR7HIX
98076-57740	B7HS	BR7HIX
98076-5801G	BR6HSA-10	
98076-58112	BP8HK	
98076-58710	B8HS	BR8HIX
98076-58711	BP8HS	BPR8HIX
98076-58713	BP8HSA	BPR8HIX
98076-58715	BPR8HSA	
98076-58716	BR8HS	BR8HIX
98076-58717	BPR8HS	BPR8HIX
98076-58719	BP8HS	BPR8HIX
98076-5871G	BR8HSA	
98076-5871M	B8HSA	
98076-58740	B8HS	BR8HIX
98076-58747	BPR8HS	BPR8HIX
98076-5891G	BR8HSA-9	
98076-59710	B9HS	
98076-59716	BR9HS	
98076-59740	BP9HS	
98079-52876	BPR2ES	
98079-54148	BCPR4E-11	
98079-5414G	ZFR4F-11	

Bic* = Best in class



HONDA	→ NGK	Bic*/IX
98079-54173	BUR4EB-11	
98079-54817	BPR4ES	
98079-54841	BP4ES	
98079-54846	BPR4ES	
98079-55140	BCP5EY-11	BCPR5EIX-11
98079-55141	BP5EY-11	BPR5EIX-11
98079-55144	BP5ES-11	BPR5EIX-11
98079-55145	BPR5ES-11	BPR5EIX-11
98079-55146	BPR5EY-11	BPR5EIX-11
98079-55147	BCPR5ES-11	BCPR5EIX-11
98079-55148	BCPR5E-11	
98079-55149	BCPR5EY-11	BCPR5EIX-11
98079-5514A	BCPR5EYN-11	
98079-5514B	BCP5E-11	BCPR5EIX-11
98079-5514E	BKR5E-11	BKR5EIX-11
98079-5514F	BCPR5EVX-11	BCPR5EIX-11
98079-5514G	ZFR5F-11	ZFR5FIX-11
98079-5514H	PFR5G-11	
98079-5514J	BKR5EN-11	
98079-5514N	PZFR5F-11	
98079-5514P	ZFR5J-11	
98079-5515G	ZFR6F-11	ZFR6FIX-11
98079-55173	BUR5EB-11	
98079-55174	BU5EB-11	
98079-55176	BR5EB-11	
98079-55178	B5EB-11	
98079-5517S	PFR5L-11	
98079-5517U	IFR5L11	
98079-5517V	IFR5G-11K	
98079-5517W	IZFR5F11	
98079-5547V	ZGR5A-4	
98079-55810	B5ES	
98079-55811	BP5ES	BPR5EIX
98079-55816	BR5ES	
98079-55817	BPR5ES	BPR5EIX
98079-55840	B5ES	
98079-55841	BP5ES	BPR5EIX
98079-55844	BP5EVX	BPR5EIX
98079-55846	BPR5ES	BPR5EIX
98079-55847	BR5ES	
98079-55848	B5EB	
98079-55849	BR5EB	
98079-5585V	ZGR5A	
98079-5587G	ZFR5F	ZFR5FIX-11
98079-5587V	ZGR5A	
98079-55941	BP5EY	BPR5EIX
98079-55946	BPR5EY	BPR5EIX
98079-55A4N	PZFR5F-13	
98079-56140	BCP6EY-11	BCPR6EIX-11
98079-56144	BP6ES-11	BPR6EIX-11
98079-56145	BPR6ES-11	BPR6EIX-11
98079-56146	BPR6EY-11	BPR6EIX-11

HONDA	→ NGK	Bic*/IX
98079-56147	BCPR6ES-11	BCPR6EIX-11
98079-56148	BCPR6E-11	BCPR6EIX-11
98079-56149	BCPR6EY-11	
98079-5614A	BCPR6EYN-11	
98079-5614B	BCP6E-11	BCPR6EIX-11
98079-5614E	BKR6E-11	BKR6EIX-11
98079-5614F	BCPR6EVX-11	
98079-5614G	ZFR6F-11	ZFR6FIX-11
98079-5614H	PFR6G-11	
98079-5614J	BKR6EN-11	
98079-5614N	PZFR6F-11	
98079-5614P	ZFR6J-11	
98079-5615G	ZFR6F-11	ZFR6FIX-11
98079-5615N	PZFR6F-11	
98079-56173	BUR6EB-11	
98079-56174	BU6EB-11	
98079-56175	BP6EY-11	
98079-56178	B6EB-11	
98079-56179	BR6EB-11	
98079-5617S	PFR6L-11	
98079-5617T	PFR6N-11	
98079-5617U	IFR6L11	
98079-5617V	IFR6G-11K	
98079-56614	B6EV	
98079-56614	B6EVX	
98079-56810	B6ES	
98079-56811	BP6ES	BPR6EIX
98079-56817	BR6ES	
98079-56840	B6ES	
98079-56841	BP6ES	BPR6EIX
98079-56841	BP6ES	BPR6EIX
98079-56844	BP6EVX	BPR6EIX
98079-56846	BPR6ES	BPR6EIX
98079-56847	BR6ES	
98079-56848	B6EB	
98079-56849	BR6EB	
98079-56874	B6EV	
98079-56941	BP6EY	
98079-56946	BPR6EY	BPR6EIX
98079-5697U	IFR6C	
98079-569BE	BKR6E-9S	
98079-569BU	IFR6C-S	
98079-56A7H	PFR6G-13	
98079-56A7S	PFR6L-13	
98079-57140	BCP7EY-11	
98079-57144	BP7ES-11	
98079-57145	BPR7ES-11	
98079-57146	BPR7EY-11	
98079-57147	BCPR7ES-11	BCPR7EIX-11
98079-57148	BCPR7E-11	BCPR7EIX-11
98079-57149	BCPR7EY-11	
98079-5714A	BCPR7EYN-11	

Bic* = Best in class



HONDA	→ NGK	Bic*/IX
98079-5714B	BCP7E-11	BCPR7EIX-11
98079-5714E	BKR7E-11	BKR7EIX-11
98079-5714F	BCPR7EVX-11	
98079-5714G	ZFR7F-11	
98079-5714H	PFR7G-11	
98079-5714J	BKR7EN-11	
98079-5714P	ZFR7J-11	
98079-5715H	PFR7G-11	
98079-57173	BUR7EB-11	
98079-57174	BU7EB-11	
98079-57175	BR6EBL-11	
98079-57176	B6EBL-11	
98079-57177	BR7EB-11	
98079-57178	B7EB-11	
98079-57179	BP7EY-11	
98079-5717U	IFR7L11	
98079-5717V	IFR7G-11K	
98079-571BH	PFR7G-11S	
98079-571BV	IFR7G-11KS	
98079-5747U	6G	
98079-57614	B7EVX	
98079-57614	B7EV	
98079-57810	B7ES	
98079-57811	BP7ES	BPR7EIX
98079-57816	BR7ES	
98079-57840	B7ES	
98079-57841	BP7ES	BPR7EIX
98079-57846	BPRTES	BPR7EIX
98079-57847	BR7ES	
98079-57848	B7EB	
98079-57849	BR7EB	
98079-5785G	ZFR7F	
98079-57874	B7EV	
98079-57876	BR7ES	
98079-57877	BR7ES	
98079-5787G	ZFR7F	
98079-5787T	PFR7N-D	
98079-57941	BP7EY	
98079-57946	BPR7EY	
98079-5814E	BKR8E-11	
98079-5817U	FR8BI-11	
98079-58644	B8EV	BR8EIX
98079-58644	B8EVX	BR8EIX
98079-58646	BR8EVX	BR8EIX
98079-58648	B8EG	
98079-58649	BR8EG	
98079-58678	B8EG	
98079-58679	BR8EG	
98079-58810	B8ES	BR8EIX
98079-58812	B9ECS	
98079-58816	BR8ES	BR8EIX
98079-58819	BR8ECS	

HONDA	→ NGK	Bic*/IX
98079-58840	B8ES	BR8EIX
98079-58842	B8ECS	
98079-58845	BR8ECM	
98079-58846	BR8ES	BR8EIX
98079-58847	BPR8ES	
98079-58870	B8ES	BR8EIX
98079-58872	B8ECS	
98079-58875	BR8ECM	
98079-58876	BR8ES	BR8EIX
98079-5917U	FR9BI-11	
98079-59644	B9EVX	BR9EIX
98079-59646	BR9EVX	BR9EIX
98079-59648	B9EG	
98079-59649	BR9EG	
98079-59678	B9EG	
98079-59679	BR9EG	
98079-59810	B9ES	BR9EIX
98079-59811	B9ES	BR9EIX
98079-59816	BR9ES	BR9EIX
98079-59819	BR9ECS	
98079-59840	B9ES	BR9EIX
98079-59842	B9ECS	
98079-59845	BR9ECM	
98079-59847	BR9ES	BR9EIX
98079-59870	B9ES	BR9EIX
98079-59872	B9ECS	
98079-59875	BR9ECM	
98079-59876	BR9ES	BR9EIX
98079-60616	BR10EVX	BR10EIX
98079-60646	BR10EV	BR10EIX
98079-60646	BR10EVX	BR10EIX
98079-60648	B10EG	
98079-60649	BR10EG	
98079-60676	BR10EVX	BR10EIX
98079-60678	B10EG	
98079-60679	BR10EG	
98079-60817	BR10ES	BR10EIX
98079-60819	BR10ECS	
98079-60842	B10ECS	
98079-60845	BR10ECM	
98079-60872	B10ECS	
98079-60875	BR10ECM	
9807B-5517W	IZFR5K11	
9807B-5615W	IZFR6K11	
9807B-5617P	ZFR6K-11	
9807B-5617W	IZFR6K11	
9807B-56A7W	IZFR6K13	
98179-56841	BP6ES	BPR6EIX
H9851-5517J	ZFR5FI-11G	
H9851-5517K	FR5CI-11G	
H9851-5517Q	FR5DI-11G	
H9851-5617J	ZFR6FI-11G	



HONDA	→ NGK	Bic*/IX
H9851-5617K	FR6CI-11G	
H9851-5617Q	FR6DI-11G	
H9851-5717K	FR7CI-11G	
H9853-5617L	ZFR6KI-11G	
H9858-5617K	FR6CI-11G	

ISOLATOR	→ NGK	Bic*/IX
6B	BP6HS	BPR6HIX
7A	B6HS	BR6HIX
7B	BP6HS	BPR6HIX
7D	BP6ES	BPR6EIX
A5D	BP7EFS	
A7D	BP6EFS	
FM14-145/2	BP5ES	BPR5EIX
FM14-175/2	BP6ES	BPR6EIX
FM14-200/2	BP6ES	BPR6EIX
FM14-225/2	BP7ES	BPR7EIX
M14-145	B5HS	
M14-175	B6HS	BR6HIX
M14-175/2	B6ES	
M14-225	B7HS	BR7HIX
M14-240	B8HS	BR8HIX
M14-260	B9HS	
M14-95	B4H	
M18-225	A7	
M18-240	A7	
PM14-225	BP7HS	BPR7HIX
U7D	BCP6ES	BCPR6EIX-11
U8D	BCP5ES	BCPR5EIX-11
ZM14-260	B8HS	BR8HIX

ITALJET	→ NGK	Bic*/IX
94004	BR7HS	BR7HIX
94015	DR8EA	DR8EIX
94025	BR8HS	BR8HIX
94029	BR9ES	BR9EIX
94032	CR7E	CR7EIX

KAWASAKI	→ NGK	Bic*/IX
92070-2077	BPR6ES	BPR6EIX
E92070001	B7HS	BR7HIX
E92070014	B6ES	
E92070015	B7ES	
E92070036	B9HS	
E92070037	B8ES	BR8EIX
E92070037	B8ES	BR8EIX
E92070054	B9ES	BR9EIX
E92070054	B9ES	BR9EIX
E920701002	B7ES	
E920701019	DR8ES	DR8EIX
E920701019	DR8ES	DR8EIX
E920701024	BP6ES	BPR6EIX

KAWASAKI	→ NGK	Bic*/IX
E920701025	BPR6ES	BPR6EIX
E920701025	BPR6ES	BPR6EIX
E920701026	BP7ES	BPR7EIX
E920701027	BPR7ES	BPR7EIX
E920701034	D9EA	DR9EIX
E920701034	D9EA	DR9EIX
E920701044	BPR8ES	
E920701065	DPR8EA-9	DPR8EIX-9
E920701065	DPR8EA-9	DPR8EIX-9
E920701066	DP8EA-9	DPR8EIX-9
E920701068	DPR9EA-9	DPR9EIX-9
E920701068	DPR9EA-9	DPR9EIX-9
E920701109	BR9ES	BR9EIX
E920701109	BR9ES	BR9EIX
E920701113	DR7ES	
E920701114	C6HSA	CR6HIX
E920701116	DR8ESL	DR8EIX
E920701116	DR8ESL	DR8EIX
E920701125	DPR7EA-9	DPR7EIX-9
E920701125	DPR7EA-9	DPR7EIX-9
E920701138	DPR6EA-9	
E920701143	CR9E	CR9EIX
E920701143	CR9E	CR9EIX
E920701145	CR9EK	
E920701145	CR9EK	
E920701154	CR7HSA	CR7HIX
E920701155	CR8HSA	CR8HIX
E920701155	CR8HSA	CR8HIX
E920701158	CR8EK	
E920701158	CR8EK	
E920701169	CR8E	CR8EIX
E920701169	CR8E	CR8EIX
E920701173	BR10ES	BR10EIX
E920701189	DR9EA	DR9EIX
E920701189	DR9EA	DR9EIX
E920701199	DR8EA	DR8EIX
E920701199	DR8EA	DR8EIX
E920701209	CR7E	CR7EIX
E920701209	CR7E	CR7EIX
E920701250	DPR5EA-9	
E920701250	DPR5EA-9	
E920701254	CR9EKPA	
E920701255	CR8EKPA	
E920702078	BR8ES	BR8EIX
E920702078	BR8ES	BR8EIX

MARELLI	→ NGK	Bic*/IX
7LCR	BKR6E	BKR6EIX
7LPR	BKR6E	BKR6EIX
8LCR	BCPR7ES	BCPR7EIX
8LDCR	PTR5A-13	
8LPR	BCPR7ES	BCPR7EIX



MARELLI	→ NGK	Bic*/IX
AW56C	BM7A	
AW5C	BM6A	
CM1N	AB2	
CM2N	AB2	
CM3N	A6	
CM4N	A6	
CM5N	A6	
CM6N	A7	
CU7N	C7HSA	CR7HIX
CW101L	B85EGV	
CW10L	B8EG	
CW112L	B9EG	
CW11L	B9EG	
CW12L	B9EG	
CW12NV	BUH	
CW13L	B10EG	
CW14L	B10EG	
CW225A	B6HS	BR6HIX
CW250A	B7HS	BR7HIX
CW25N	B4H	
CW260N	B7HS	BR7HIX
CW2C	B2	
CW2CJ	B2	
CW2L	B4ES	
CW2N	B4H	
CW3C	B4	
CW3CJ	B4	
CW3CP	BP4	
CW3L	B4ES	
CW3N	B4H	
CW4A	B5ES	
CW4C	B4	
CW4CJ	B4	
CW4CP	BP4	
CW4L	B4ES	
CW4LP	BP4ES	
CW4N	B4H	
CW4NJ	B4H	
CW55N	B5HS	
CW5C	B4	
CW5CP	BP5S	
CW5L	B5ES	
CW5LJ	B5ES	
CW5LP	BP5ES	BPR5EIX
CW5LS	B5ES	
CW5LSZ	B5ES	
CW5N	B5HS	
CW5NJ	B5HS	
CW5NP	BP5HS	
CW5NR	BR5HS	
CW5NS	B5HS	
CW5NSZ	B5HS	

MARELLI	→ NGK	Bic*/IX
CW67L	B6ES	
CW67LP	BP6ES	BPR6EIX
CW67N	BP6HS	BPR6HIX
CW67NJ	B6HS	BR6HIX
CW67NR	BR6HS	BR6HIX
CW67P	BP5ES	BPR5EIX
CW6C	B6S	
CW6CE	BM6A	
CW6CJ	B6S	
CW6L	B5ES	
CW6LJ	B5ES	
CW6LP	BP5ES	BPR5EIX
CW6LR	BR5ES	
CW6LS	B5ES	
CW6LSZ	B5ES	
CW6N	B6HS	BR6HIX
CW6NE	BM6A	
CW6NJ	B6HS	BR6HIX
CW6NP	BP6HS	BPR6HIX
CW6NPR	BPR6HS	BPR6HIX
CW6NR	BR6HS	BR6HIX
CW75LP	BP6ES	BPR6EIX
CW78L	B6ES	
CW78LP	BP6ES	BPR6EIX
CW78LPR	BPR6ES	BPR6EIX
CW78LPS	BP6ES	BPR6EIX
CW7C	B6S	
CW7L	B6ES	
CW7LCR	BKR6E	BKR6EIX
CW7LJ	B6ES	
CW7LP	BP6ES	BPR6EIX
CW7LPH	BP6ES	BPR6EIX
CW7LPR	BPR6ES	BPR6EIX
CW7LR	BR6ES	
CW7N	B6HS	BR6HIX
CW7NJ	B6HS	BR6HIX
CW7NP	BP6HS	BPR6HIX
CW7NPR	BPR6HS	BPR6HIX
CW7NR	BR6HS	BR6HIX
CW89LP	BP7ES	BPR7EIX
CW8CJ	B7S	
CW8L	B7ES	
CW8LCR	BCPR7ES	BCPR7EIX
CW8LJ	B7ES	
CW8LP	BP7ES	BPR7EIX
CW8LPR	BPR7ES	BPR7EIX
CW8LPS	BP7ES	BPR7EIX
CW8N	B7HS	BR7HIX
CW8NP	BP7HS	BPR7HIX
CW8NR	BR7HS	BR7HIX
CW9L	B8ES	BR8EIX
CW9LJ	B8ES	BR8EIX

Bic* = Best in class



MARELLI	→	NGK	Bic*/IX
CW9LP		BP8ES	
CW9N		B8HS	BR8HIX
CWC12NJ		B8HS	BR8HIX
CWC67NJ		B6HS	BR6HIX
CWC6NJ		B6HS	BR6HIX
CWC7NJ		B6HS	BR6HIX
CWC9NJ		B7HS	BR7HIX
CWF11L		B8EVX	BR8EIX
CWP10L		B9EVX	BR9EIX
CWP10N		B9HVX	
CWP11L		B10EGV	
CWP5N		B6HVX	BR6HIX
CWP6N		B6HVX	BR6HIX
CWP7L		B6EVX	
CWP7N		B6HVX	BR6HIX
CWP8L		B7EVX	
CWP8N		B7HVX	BR7HIX
CWP9L		B8EVX	BR8EIX
CWP9N		B8HVX	BR8HIX
CX6N		D6HA	
CX8L		D8EA	DR8EIX
CX8N		D8HA	
DW4CJR		BR6S	
F6NC		BP5HS	
F6NCR		BPR5HS	
F7LC		BP6ES	BPR6EIX
F7LCR		BPR6ES	BPR6EIX
F7NC		BP6HS	BPR6HIX
F7NCR		BPR6HS	BPR6HIX
F8LC		BP7ES	BPR7EIX
F8LCR		BP7ES	BPR7EIX
FC6N		B5HS	
FC7N		B6HS	BR6HIX
FC9L		BP8ES	
SW5C		BM6F	
T7LC		BP6EFS	
T7LCR		BPR6EFS	
T8LC		BP7EFS	
T8LCR		BPR7EFS	
TM2NP		AP5FS	
TM3N		A5FS	
TM3NP		A5FS	
TM4N		A5FS	
TM4NP		AP6FS	
TW4LP		BP5EFS	
TW5NP		BP5FS	
TW6NP		BP6FS	
TW7LP		BP6EFS	
TW78LPR		BPR6EFS	
TW78NPR		BPR6FS	
TW7LP		BP6EFS	
TW7LPR		BPR6EFS	

MARELLI	→	NGK	Bic*/IX
TW7NP		BP6FS	
MEGA FIRE	→	NGK	Bic*/IX
SE17JC		BM4A	
SE8JC		BM6A	
OREGON	→	NGK	Bic*/IX
ODR17YC		BCPR5ES	BCPR5EIX-11
OJ17		B4LM	
OJ19		B2LM	
OJR17		BR4LM	
OK17C		B6S	
OK19		B4	
OL15YC		BP6ES	BPR6EIX
OL17YC		BP5ES	BPR5EIX
OL17YC		BPR5ES	BPR5EIX
OLY15YC		BPR6ES	BPR6EIX
ON17C		B6HS	BR6HIX
ON17YC		BP5HS	
ONR15YC		BPR6HS	BPR6HIX
OP15		BM7A	
OP15Y		BPM7A	
OP17		BM6A	
OP18Y		BPM6A	
OPR15		BMR7A	
OPR15Y		BPMR7A	
OPR17		BMR6A	
OPR18Y		BPMR6A	
ORJ19		BR2LM	
OUI7		BM6F	
PAL	→	NGK	Bic*/IX
14-5		B4H	
14-5Y		BP4H	
14-7		B5HS	
14-7Y		BP5HS	
14-8		B6HS	BR6HIX
14-8R		BR6HS	BR6HIX
14-8Y		BP6HS	BPR6HIX
14-9		B8HS	BR8HIX
14-9R		BR7HS	BR7HIX
14-9Y		BP7HS	BPR7HIX
14K-5		B4	
14K-5Y		BP4	
14K-7Y		BP5S	
14K-8		B6S	
14L-5		B5ES	
14L-5R		BR5ES	
14L-5Y		BP5ES	BPR5EIX
14L-7		B6ES	
14L-7R		BR6ES	
14L-7Y		BP6ES	BPR6EIX

Bic* = Best in class



PAL	→ NGK	Bic*/IX
14L-8	B6ES	
14L-8Y	BP6ES	BPR6EIX
14L-9	B7ES	
14L-9Y	BP7ES	BPR7EIX
17-9	B7HS	BR7HIX
18-5	A6	
18-5R	A6	
18-7	A7	
18-8W	A8	
18F-5	A5FS	
B12YC	DP9EA-9	DPR9EIX-9
B14YC	DP8EA-9	DPR8EIX-9
B15YC	DP7EA-9	DPR7EIX-9
D14YC	BCP7ES	BCPR7EIX
D15YC	BCP6ES	BCPR6EIX-11
D17YC	BCP5ES	BCPR5EIX-11
DR14YC	BCPR7ES	BCPR7EIX
DR15YC	BKR6E	BKR6EIX
DR17YC	BCPR5ES	BCPR5EIX-11
G14YC	BP7EFS	
G15YC	BP6EFS	
G17YC	BP5EFS	
K15YC	BP6S	
K17C	B6S	
K17Y	BP5S	
K19	B4	
L08JW	B11EN	
L08W	B11EGV	
L10JW	B95EN	
L12W	B9EVX	BR9EIX
L12YC	BP9ES	
L14C	B8ES	BR8EIX
L14YC	BP7ES	BPR7EIX
L15C	B7ES	
L15W	B8EVX	BR8EIX
L15YC	BP6ES	BPR6EIX
L17C	B6ES	
L17Y	BP4E	
L17YC	BP5ES	BPR5EIX
L19	B4E	
L19C	B5ES	
L5Y	BP5ES	BPR5EIX
L7Y	BP6ES	BPR6EIX
L8	B6ES	
L8Y	BP6ES	BPR6EIX
L9Y	BP7ES	BPR7EIX
LR12YC	BPR8ES	
LR14YC	BPR7ES	BPR7EIX
LR15YC	BPR6ES	BPR6EIX
N12YC	BP8ES	
N14C	B9HS	
N14YC	BP7HS	BPR7HIX

PAL	→ NGK	Bic*/IX
N15C	B7ES	
N15YC	BP6HS	BPR6HIX
N17C	B6HS	BR6HIX
N17Y	BP4H	
N17YC	BP5HS	
N19	B4H	
N19C	B5HS	
N7	B6HS	BR6HIX
N7Y	BP6HS	BPR6HIX
N8	B7HS	BR7HIX
N8Y	BP7HS	BPR7HIX
NR12YC	BPR8HS	BPR8HIX
NR15YC	BPR6HS	BPR6HIX
P15	BM7A	
P15Y	BPM7A	
P17	BM6A	
P17Y	BPM6A	
PR15Y	BPMR7A	
PR17Y	BPMR6A	
S14L-13	B8EG	
S14L-15	B9EG	
S14L-17	B10EG	
U17	BM6F	

SPLITFIRE	→ NGK	Bic*/IX
TP006A	BP8EVX	
TP006B	BP7EVX	BPR7EIX
TP006C	BP6EVX	BPR6EIX
TP006D	BP5EVX	BPR5EIX
TP006E	BP5EVX	BPR5EIX
TP406B	BR9EVX	BR9EIX
TP406B	B9EVX	BR9EIX
TP406C	B8EVX	BR8EIX
TP406C	BR8EVX	BR8EIX
TP416B	DP9EVX-9	DPR9EIX-9
TP416C	DP8EVX-9	DPR8EIX-9
TP430B	CR9EVX	
TP430C	CR8EVX	CR8EIX

SUZUKI	→ NGK	Bic*/IX
09482-00006	B-4	
09482-00011	B4H	
09482-00036	BP-4H	
09482-00051	B6S	
09482-00053	B7S	
09482-00054	B6ES	
09482-00059	BP6HS	BPR6HIX
09482-00064	B6HV	BR6HIX
09482-00065	B7HV	BR7HIX
09482-00066	B9ES	BR9EIX
09482-00074	BP6HS	BPR6HIX
09482-00079	BR6ES	



SUZUKI	→ NGK	Bic*/IX
09482-00082	B7HS	BR7HIX
09482-00084	BP6HS	BPR6HIX
09482-00088	BR6HS	BR6HIX
09482-00089	B7ES	
09482-00091	B8ES	BR8EIX
09482-00095	B6HS	BR6HIX
09482-00096	B8EV	BR8EIX
09482-00097	B9EV	BR9EIX
09482-00098	BR9ES	BR9EIX
09482-00102	BR8HS	BR8HIX
09482-00105	BP7HS	BPR7HIX
09482-00111	AU10EFP	
09482-00115	BR9EV	
09482-00115	BR9EVX	BR9EIX
09482-00116	BR7HS	BR7HIX
09482-00117	BR7ES	
09482-00118	BP6ES	BPR6EIX
09482-00121	BR8ES	BR8EIX
09482-00124	BP5HS	
09482-00127	BR9ES	BR9EIX
09482-00129	BP5EA	
09482-00131	BP5ES	BPR5EIX
09482-00136	BPR-4H	
09482-00139	BP7ES	BPR7EIX
09482-00141	BPR6HS	BPR6HIX
09482-00142	B4H	
09482-00143	BR5HS	
09482-00144	D8EA	DR8EIX
09482-00147	BPR5HS	
09482-00148	BP-4E	
09482-00149	DR8ESL	DR8EIX
09482-00151	B8HS	BR8HIX
09482-00153	B7HS	BR7HIX
09482-00155	BPR5ES	BPR5EIX
09482-00157	BR8HS	BR8HIX
09482-00161	BP4HS	
09482-00163	BP5HA	
09482-00167-000	BPR5EAL	
09482-00167-001	BPR5ES	BPR5EIX
09482-00170	BP4HA	
09482-00172	BP2HA	
09482-00175	BP8ES	
09482-00177	BP6ES	BPR6EIX
09482-00181	BR10EV	BR10EIX
09482-00182	D7EA	
09482-00184	D9EA	DR9EIX
09482-00198	B8HS	BR8HIX
09482-00205	BPR4HS	
09482-00208	B8EGV	
09482-00209	B9EGV	
09482-00210	B10EGV	
09482-00218	BP5EA-11	

SUZUKI	→ NGK	Bic*/IX
09482-00219	BP5EA-L-11	
09482-00220	DR7ES	
09482-00221	DR8ES	DR8EIX
09482-00225	B8ES	BR8EIX
09482-00226	BP7ES	BPR7EIX
09482-00227	CM-6	
09482-00228	BP5HS	
09482-00229	BPR6HS	BPR6HIX
09482-00230	BR8HS	BR8HIX
09482-00237	B8HS	BR8HIX
09482-00239	BPR8ES	
09482-00255	BPR7HS	BPR7HIX
09482-00258	BPMR6A	
09482-00259	BP6HS	BPR6HIX
09482-00260	BPM4A	
09482-00261	BPMR4A	
09482-00262	BP5HS-10	
09482-00264	BP6HS-10	
09482-00268	BP8HS	BPR8HIX
09482-00269	B7HS-10	
09482-00277	BR7HS-10	
09482-00278	B8HS-10	
09482-00279	B8HS-10	
09482-00280	BR8HS-10	
09482-00281	BPR6HS	BPR6HIX
09482-00282	B5HS	
09482-00285	BPR6ES-11	BPR6EIX-11
09482-00287	BP5ES-11	BPR5EIX-11
09482-00288	BP4ES	
09482-00289	B4H	
09482-00290	BP-4H	
09482-00291	BP4HS	
09482-00294	C6HA	
09482-00299	BPR6ES	BPR6EIX
09482-00309	B5HS	
09482-00310	C7HA	
09482-00316	BPR5HS	
09482-00317	C8HA	
09482-00321	C8HSA	CR8HIX
09482-00322	BP5EV	BPR5EIX
09482-00325	BR8EV	BR8EIX
09482-00327	BR6HS-10	
09482-00328	DP9EA-9	DPR9EIX-9
09482-00330	DPR9EA-9	DPR8EIX-9
09482-00332	DP8EA-9	DPR8EIX-9
09482-00334	DPR8EA-9	DPR8EIX-9
09482-00338	B6HS-10	
09482-00339	B6HS-10	
09482-00340	CR6HS	CR6HIX
09482-00341	BR6HS-10	
09482-00348	BR8ES	BR8EIX
09482-00349	BR9ES	BR9EIX



SUZUKI	→ NGK	Bic*/IX
09482-00351	B9ES	BR9EIX
09482-00352	DP7EA-9	DP7EIX-9
09482-00354	DPRT7EA-9	DP7EIX-9
09482-00358	BR4HS	
09482-00359	BPR5HS	
09482-00360	BR10ES	BR10EIX
09482-00362	ZGR5A	
09482-00365	J9A	
09482-00366	JR9A	
09482-00367	BPR4HS	
09482-00369	DCP7E	
09482-00370	BR8HS-10	
09482-00371	J10A	
09482-00372	JR10A	
09482-00373	L8A	
09482-00375	B8HS-10	
09482-00376	B8HS	BR8HIX
09482-00379	DCP8E	
09482-00380	PJR6A	
09482-00381	PJR7A	
09482-00382	PJR8A	
09482-00384	DCP8EVX	
09482-00385	BP7ES	BPR7EIX
09482-00386	DCP7EVX	
09482-00388	J9B	
09482-00389	JR9B	
09482-00390	J10B	
09482-00391	JR10B	
09482-00394	DCP6E	
09482-00395	ZG5E	
09482-00397	JR9C	
09482-00398	DR7EA	
09482-00399	DR8EA	DR8EIX
09482-00400	DR9EA	DR9EIX
09482-00401	JR8C	
09482-00404	LR8A	
09482-00406	CR6HSA	CR6HIX
09482-00406-000	CR6HSA	CR6HIX
09482-00408	CR7HSA	CR7HIX
09482-00409	BPR6ES	BPR6EIX
09482-00410	CR9EK	
09482-00412	CR8EK	
09482-00414	CR7EK	
09482-00417	R2198-10P	
09482-00418	R2198-11P	
09482-00419	R2198-12P	
09482-00422	R5184-95	
09482-00423	R5184-10	
09482-00424	R5184-105	
09482-00426	BK6E	
09482-00427	BKR6E	BKR6EIX
09482-00429	BKR6E	BKR6EIX

SUZUKI	→ NGK	Bic*/IX
09482-00430	R017-10	
09482-00431	R017-11	
09482-00432	BPR5E	BPR5EIX
09482-00433	BPR5EY-11	BPR5EIX-11
09482-00446	DCPR6E	
09482-00448	DCPR7E	DCPR7EIX
09482-00450	DCPR8E	DCPR8EIX
09482-00452	ZGR5A	
09482-00454	ZGR5E	
09482-00456	CR8E	CR8EIX
09482-00458	CR9E	CR9EIX
09482-00460	CR10E	
09482-00462	CR10EK	
09482-00463	CR10EK	
09482-00464	BR8HCS-10	
09482-00467	BR9HS-10	
09482-00470	BR8ECM	
09482-00472	BR9ECM	
09482-00474	BR10ECM	
09482-00477	BKR5E	BKR5EIX
09482-00478	B10ES	BR10EIX
09482-00479	DCPR7EVX	DCPR7EIX
09482-00481	DCPR8EVX	DCPR8EIX
09482-00485	CR8HSA	CR8HIX
09482-00486	BR8HCS-10	
09482-00487	BPR6ES	BPR6EIX
09482-00491	JR8B	
09482-00493	BPR5E-11	BPR5EIX-11
09482-00494	BKR6E-11	BKR6EIX-11
09482-00495	BPR7ES	BPR7EIX
09482-00499	R4118S-8	
09482-00500	R4118S-9	
09482-00502	BP5EY	BPR5EIX
09482-00504	BPR5EY	BPR5EIX
09482-00509	R6918B-8	
09482-00511	R6918B-7	
09482-00513	R0045J-10	
09482-00514	R0045J-11	
09482-00516	CR7E	CR7EIX
09482-00519	BR9EYA	
09482-00521	PGR5A	
09482-00522	BPR7HS-10	
09482-00523	BPR8HS	BPR8HIX
09482-00525	IKR7A	
09482-00526	BR10EYA	
09482-00527	KR7AI	
09482-00528	CR6E	
09482-00530	BPR6HS	BPR6HIX
09482-00531	BP6HS	BPR6HIX
09482-00532	B7HS-10	
09482-00533	BR7HS-10	
09482-00534	B6HS-10	

Bic* = Best in class



SUZUKI	→ NGK	Bic*/IX
09482-00535	BR6HS-10	
09482-00537	DCPR9EVX	DCPR9EIX
09482-00546	GR5AI-10	
09482-00547	IFR5E11	
09482-00548	IFR6E11	
09482-00549	IFR5J11	
09482-00550	IFR6J11	
09482-00561	BR8EG	
09482-00564	BR9EYA	
09482-00565	KR8AI	
09482-00566	BKR5E-11	BKR5EIX-11
09482-00584	CR8EIB-10	
09482-69001	BPR6HS	BPR6HIX
99000-69257-000	R0161-10	
99000-69257-001	R216-11	
99000-69257-002	R4630A-95	
99000-69571	C7HSA	CR7HIX
99000-69835-B6R	BR6HIX	
99000-69835-B7R	BR7HIX	BR7HIX
99000-69835-B8R	BR8HIX	
99000-69835-BP6	BPR6HIX	
99000-69835-BP7	BPR7HIX	
99000-69835-BR1	BR10EIX	
99000-69835-BR8	BR8EIX	
99000-69835-BR9	BR9EIX	
99000-69835-C6R	CR6HIX	
99000-69835-C7R	CR7HIX	
99000-69835-C8R	CR8HIX	
99000-69835-CR7	CR7EIX	
99000-69835-CR8	CR8EIX	
99000-69835-CR9	CR9EIX	
99000-69835-DC7	DPR7EIX-9	
99000-69835-DC8	DCR8EIX	
99000-69835-DR8	DR8EIX	
99000-69835-DR9	DR9EIX	
99000-69835-PR8	DPR8EIX-9	
99000-69835-PR9	DPR9EIX-9	
99000-79A45-B0E	B10EVX	BR10EIX
99000-79A45-B6H	B6HVX	BR6HIX
99000-79A45-B7E	B7EVX	
99000-79A45-B7H	B7HVX	BR7HIX
99000-79A45-B8E	B8EVX	BR8EIX
99000-79A45-B8H	B8HVX	BR8HIX
99000-79A45-B9E	B9EVX	BR9EIX
99000-79A45-P8E	BP8EVX	
99000-79K60-BP6	BPR6EIX-11	
99000-79K60-DC7	DCPR7EIX	
99000-79K60-K5R	BKR5EIX	
99000-79K60-K6R	BKR6EIX	
99000-79K60-KR6	BKR6EIX-11	
99000-79K60-P5R	BPR5EIX	
99000-79K60-P6R	BPR6EIX	

SUZUKI	→ NGK	Bic*/IX
99000-79K60-P7R	BPR7EIX	
99000-79K60-PR5	BPR5EIX-11	
99000-79L65-001	BKR6EIX-11P	
99000-79L65-002	BKR5EIX-P	
99000-79L65-003	BKR6EIX-P	
99000-79L65-004	DCPR7EIX-P	
99000-79L65-005	BKR5EIX-11P	
99000-79L65-006	BKR7EIX-P	
99000-79L65-007	BPR5EIX-P	
99000-79L65-008	BPR5EIX-11P	
99000-79L65-009	BPR6EIX-P	
99000-79L65-010	BPR6EIX-11P	

TORCH	→ NGK	Bic*/IX
A7RTC	C7HSA	
D6RTC-9	DPR6EA-9	
D7RTC-9	DPR7EA-9	
D8RTC	DPR8EA-8	DPR8EIX-9
L7T	BM6A	

YAMAHA	→ NGK	Bic*/IX
90793 20029	B95EGV	
90793 20030	B105EGV	
90793 20032	B10EG	
90793-20001	B7EVX	
90793-20002	B8EVX	BR8EIX
90793-20003	B9EVX	BR9EIX
90793-20004	B10EVX	BR10EIX
90793-20005	B6HVX	BR6HIX
90793-20006	B7HVX	BR7HIX
90793-20007	B8HVX	BR8HIX
90793-20008	BP8EVX	
90793-20010	D7EVX	
90793-20011	D8EVX	DR8EIX
90793-20012	D9EVX	DR9EIX
90793-20013	DPR8EIX-9	DPR8EIX-9
90793-20014	DP9EVX-9	DPR9EIX-9
90793-20015	C7HVX	CR7HIX
90793-20016	C8HVX	CR8HIX
90793-20017	B10HV	BR10HIX
90793-20018	B10EV	BR10EIX
90793-20021	D7EV	
90793-20022	D8EV	DR8EIX
90793-20023	D9EV	DR9EIX
90793-20024	BP5EV	BPR5EIX
90793-20025	BP8EV	
90793-20026	BP9EV	
90793-20027	BP10EV	
90793-20028	B85EGV	
90793-20029	B95EGV	
90793-20030	B105EGV	
90793-20031	B11EGV	



YAMAHA	→ NGK	Bic*/IX
90793-20032	B10EG	
90793-20035	BP-4H	
90793-20036	BP4HSA	
90793-20037	BP4HS-10	
90793-20038	BP5HS-10	
90793-20039	BP6HSA	
90793-20040	BP5ES-11	BPR5EIX-11
90793-20045	BP6ES-11	BPR6EIX-11
90793-20051	D8HA	
90793-20053	D10EA	
90793-20054	DP6EA-9	
90793-20055	C4HA	
90793-20056	L8A	
90793-20057	BR6HS	BR6HIX
90793-20058	BR7HS-10	
90793-20060	BR6ES	
90793-20062	BPR8ES	
90793-20065	BPR5EY	BPR5EIX
90793-20066	BPR5EY-11	BPR5EIX-11
90793-20067	BP6EY	BPR6EIX
90793-20068	BPR6EY-11	BPR6EIX-11
90793-20069	BPR7EY-11	
90793-20071	CR7HS	
90793-20072	CR8HS	CR8HIX
90793-20075	DR8HS	
90793-20076	DR7ES	
90793-20077	DR8ES	DR8EIX
90793-20080	DPR9EA-9	DPR8EIX-9
90793-20081	C7HV	CR7HIX
90793-20082	C8HV	CR8HIX
90793-20083	DP8EV-9	DPR8EIX-9
90793-20084	DP9EV-9	DPR9EIX-9
90793-20085	BP6HV	
90793-20086	BP7HV	BPR7HIX
90793-20090	BPMTA	
90793-20091	BPM4A	
90793-20092	BPM4A-10	
90793-20093	BPM6A-10	
90793-20094	BPMR4A	
90793-20095	BPMR4A-10	
90793-20096	BPMR6A-10	
90793-20098	BPMR7A	
90793-20099	B9HVX	
90793-20100	B10HVX	BR10HIX
90793-20101	BP6HVX	
90793-20102	BP7HVX	BPR7HIX
90793-20103	BP8HVX	BPR8HIX
90793-20104	BP9HVX	
90793-20105	B6EVX	
90793-20106	BP5EVX	BPR5EIX
90793-20107	BP6EVX	BPR6EIX
90793-20108	BP5EVX-11	BPR5EIX-11

YAMAHA	→ NGK	Bic*/IX
90793-20109	BP6EVX-11	BPR6EIX-11
90793-20110	BP7EVX	BPR7EIX
90793-20111	BP7EVX-11	
90793-20112	BR8EVX	BR8EIX
90793-20113	BP8HS-10	
90793-20115	BR10EV	BR10EIX
90793-20116	BPR5EVX	BPR5EIX
90793-20117	BPR6EVX	BPR6EIX
90793-20118	BR9EVX	BR9EIX
90793-20119	DPR8EVX-9	DPR8EIX-9
90793-20120	DPR9EVX-9	DPR8EIX-9
90793-20121	BR6FS	
90793-20122	C8EVX	CR8EIX
90793-20123	C9EVX	CR9EIX
90793-20124	CR8EVX	CR8EIX
90793-20125	CR9EVX	
90793-20127	BPR7ES-11	
90793-20128	BR4ES	
90793-20129	BPR7HS-10	
90793-20130	BR4HS	
90793-20131	BR5HS	
90793-20132	CR6HSA	CR6HIX
90793-20133	CR7HSA	CR7HIX
90793-20134	BR8EG	
90793-20135	BR9EG	
90793-20136	BR10EG	
90793-20138	BPR6EV	BPR6EIX
90793-20139	BR8ECM	
90793-20140	BR10ECM	
90793-20149	RO256R-10	
90793-20150	CR8EIX	
90793-20151	CR9EIX	
90793-20152	DR8EIX	
90793-20153	DR9EIX	
90793-20154	DPR8EIX-9	
90793-20155	DPR9EIX-9	
90793-20156	BPR6HIX	
90793-20157	BPR7HIX	
90793-20158	BR6HIX	
90793-20159	BR7HIX	BR7HIX
90793-20160	BR8EIX	
90793-20161	BR9EIX	
90793-20162	CR8EIX-9	
90793-20163	CR9EIX-9	
90793-20164	BR8HIX	
90793-20165	BR10EIX	
90793-20166	BPR8HIX	
90793-20167	BPR5EIX	
90793-20168	BPR6EIX	
90793-20169	CR5HIX	
90793-20170	CR6HIX	
90793-20171	CR7HIX	



YAMAHA	→ NGK	Bic*/IX
90793-20172	CR7EIX	
90793-20173	DPR7EIX-9	
90793-20174	CR8HIX	
90793-20175	BPR7EIX	
9079E-NG001	B8EVX	BR8EIX
9079E-NG002	B9EVX	BR9EIX
9079E-NG003	B10EVX	BR10EIX
9079E-NG004	BR8EVX	BR8EIX
9079E-NG005	BR9EVX	BR9EIX
90890-78082	B10EGV	
90890-78063	C5HA	
90890-78064	C8HA	
90890-78065	D6HA	
90890-78066	D6EA	
90890-78068	DP9EA-9	DPR9EIX-9
90890-78070	B9HS-10	
90890-78071	BR8HS	BPR8HIX
90890-78072	BP9ES	
90890-78073	BP4HA	
90890-78074	BM6A	
90890-78075	BM7A	
90890-78076	BPM6A	
90890-78077	BR9HS	
90890-78078	BP7EV	
90890-78079	BP6EV	BPR6EIX
90890-78081	B5EV	
90890-78082	B10EGV	
94700-00394	R0256R-10	
94701-00039	B6HS	BR6HIX
94701-00040	B7HS	BR7HIX
94701-00041	B8HS	BR8HIX
94701-00042	B9HS	
94701-00043	B6ES	
94701-00044	B7ES	
94701-00045	B8ES	BR8EIX
94701-00046	B9ES	BR9EIX
94701-00048	B8HCS	
94701-00050	BP7HS	BPR7HIX
94701-00061	B8EVX	BR8EIX
94701-00063	B9EVX	BR9EIX
94701-00069	B5HS	
94701-00078	B5ES	
94701-00108	BP6HS	BPR6HIX
94701-00110	BR7HS	BR7HIX
94701-00111	BR6ES	
94701-00112	BR7ES	
94701-00113	BR8EVX	BR8EIX
94701-00116	BP6ES	BPR6EIX
94701-00117	BP7ES	BPR7EIX
94701-00118	BP8ES	
94701-00148	B8HVX	BR8HIX
94701-00157	D8EA	DR8EIX

YAMAHA	→ NGK	Bic*/IX
94701-00159	BP4HS	
94701-00160	B8HS-10	
94701-00168	BP5HS	
94701-00188	BR9ES	BR9EIX
94701-00189	D7EA	
94701-00190	BP5HA	
94701-00193	BR9EVX	BR9EIX
94701-00194	BPR5HS	
94701-00195	BR8HS	BR8HIX
94701-00198	BPR6HS	BPR6HIX
94701-00203	DR8ESL	DR8EIX
94701-00204	BR8ES	BR8EIX
94701-00208	DR7ES	
94701-00217	B7HS-10	
94701-00218	BPR7ES	BPR7EIX
94701-00219	BPR8ES	
94701-00227	BPR7HS	BPR7HIX
94701-00232	BP6HS-10	
94701-00234	BPR6ES	BPR6EIX
94701-00237	BP8HS-10	
94701-00241	DPR8EA-9	DPR8EIX-9
94701-00248	BR6HS	BR6HIX
94701-00250	CR7HS	CR7HIX
94701-00251	BR9HS	
94701-00254	C7HSA	CR7HIX
94701-00256	C6HSA	CR6HIX
94701-00258	BPR4HS	
94701-00262	DPR7EA-9	DPR7EIX-9
94701-00263	DP7EA-9	DPR7EIX-9
94701-00264	BP7HS-10	
94701-00266	D9EA	DR9EIX
94701-00267	BP8ES-11	
94701-00268	BP8HS	BPR8HIX
94701-00273	B6HS-10	
94701-00274	BR6HS-10	
94701-00275	DP8EA-9	DPR8EIX-9
94701-00280	BPR8HS	BPR8HIX
94701-00282	CR6HS	CR6HIX
94701-00284	BP6EVX	BPR6EIX
94701-00285	BPR6EVX	BPR6EIX
94701-00287	DR8ES	DR8EIX
94701-00292	BPR6HS-10	
94701-00300	CR5HS	CR5HIX
94701-00301	B6EVX	
94701-00309	BR9HS-10	
94701-00311	BR5ES	
94701-00318	CR9E	CR9EIX
94701-00328	BPR5ES	BPR5EIX
94701-00330	CR8E	CR8EIX
94701-00332	R5184-105	
94701-00333	DR8EA	DR8EIX
94701-00340	DR9EA	DR9EIX

Bic* = Best in class



YAMAHA	→ NGK	Bic*/IX
94701 00345	DR7EA	
94701 00353	CR7E	CR7EIX
94701 00354	CR4HSA	
94701 00358	C7E	CR7EIX
94701 00361	DPR9EA-9	DPR9EIX-9
94701 00365	BR6FS	
94701 00372	CR6HSA	CR6HIX
94701 00375	DPR6EA-9	
94701 00395	CR9EK	
94701 00403	CR9EK	
94701 00406	DPR5EA-9	
94701 00408	CR9EIA-9	
94701-00315	C9E	CR9EIX
94701-00386	CR10EK	
94701-00402	CR10EK	
94701-00403	CR9EK	
94701-00406	DPR5EA-9	
94701-00408	CR9EIA-9	
94701-00410	CR9E	CR9EIX
94701-00411	CR8E	CR8EIX
94702 00044	B7ES	
94702 00045	B8ES	BR8EIX
94702 00046	B9ES	BR9EIX
94702 00149	B7HS	BR7HIX
94702 00188	BR9ES	BR9EIX
94702 00193	BR9EVX	BR9EIX
94702 00195	BR8HS	BR8HIX
94702 00204	BR8ES	BR8EIX
94702 00211	BPMR6A	
94702 00247	BR8HS-10	
94702 00248	BR6HS	BR6HIX
94702 00248	BR6HS	BR6HIX
94702 00249	BR5HS	
94702 00271	BR7HS-10	
94702 00272	BR7HS	BR7HIX
94702 00274	BR6HS-10	
94702 00309	BR9HS-10	
94702 00317	B9HS-10	
94702 00323	B8EG	
94702 00324	BR9EG	
94702 00325	B9EG	
94702 00326	BR8EG	
94702 00331	BPR4ES	
94702 00343	BR4ES	
94702 00348	BPR2ES	
94702 00349	BR7ES	
94702 00357	BR9ECM	
94702 00367	B10EG	
94702 00391	LFR5A-11	
94702 00400	LFR6A-11	
94702 00404	BKR7EKU	
94702 00405	BKR6EKU	

YAMAHA	→ NGK	Bic*/IX
94702 00409	CR9EB	CR9EIX
94702 00418	DPR6EB-9	
94702 00419	CR4HSB	
94702 00N01	BP5HM	
94702-00193	BR9EVX	BR9EIX
94702-00234	BPR6ES	BPR6EIX
94702-00372	CR6HSB	
94702-00374	R6179A-105P	
94702-00383	BR9ECS	
94702-00384	BR10ECS	
94702-00404	BKR7EKU	
94702-00405	BKR6EKU	
94702-00409	CR9EB	CR9EIX
94702-00418	DPR6EB-9	
94702-00419	CR4HSB	
94703 00277	B9EGV	
94703 00420	CPR7EA-9	
94703-00001	B4H	
94703-00039	B6HS	BR6HIX
94703-00040	B7HS	BR7HIX
94703-00041	B8HS	BR8HIX
94703-00042	B9HS	
94703-00043	B6ES	
94703-00044	B7ES	
94703-00045	B8ES	BR8EIX
94703-00046	B9ES	BR9EIX
94703-00050	BP7HS	BPR7HIX
94703-00059	B7HV	BR7HIX
94703-00060	B9HV	
94703-00062	B6HV	BR6HIX
94703-00065	B7EV	
94703-00069	B5HS	
94703-00074	B8EV	BR8EIX
94703-00075	B9EV	BR9EIX
94703-00078	B5ES	
94703-00108	BP6HS	BPR6HIX
94703-00109	BP-2E	
94703-00110	BR7HS	BR7HIX
94703-00112	BR7ES	
94703-00113	BR8EV	BR8EIX
94703-00114	BR9EV	
94703-00116	BP6ES	BPR6EIX
94703-00117	BP7ES	BPR7EIX
94703-00118	BP8ES	
94703-00133	BP5ES	BPR5EIX
94703-00143	BR8HV	
94703-00148	B8HV	
94703-00157	D8EA	DR8EIX
94703-00159	BP4HS	
94703-00160	B8HS-10	
94703-00168	BP5HS	
94703-00188	BR9ES	BR9EIX

Bic* = Best in class



B10EG	APRILIA, KTM, YAMAHA
B10EGV	GAS GAS, SIMONINI IMEA
B10ES	BETA, GARELLI
B4H	PUCH, RIXE, VELOSOLEX
B5ES	BULTACO
B5HS	BULTACO, FANTIC, GILERA, GIMSON, HERCULES, KTM, LEM, MARS, OMER, PEUGEOT, PIAGGIO, PUCH, RIEJU, RIZZATO, SACHS, TESTI, TORPADO, TORROT, ZÜNDAPP
B6ES	BETA, CARABELA, GILERA, KAWASAKI, LEM, MINARELLI, MOTO GEROSA, MOTOR HISPANIA, PIAGGIO, RIEJU, TESTI
B6HS	BAJAJ, BATAVUS, BENELLI, BMW, BOOM TRIKE, BULTACO, CARABELA, CZ, DKW, DUCATI, DUCSON, ERING, FANTIC, G.A.C. MobyLe., GARELLI, GILERA, HERCULES, HUSQVARNA, JAWA, KREIDLER, KTM, KYMCO, LAMBRETTA, MALAGUTI, MBK, MECATECNO, MINARELLI, MONTESA, MOTO GEROSA, MOTO GUZZI, MOTOR HISPANIA, NSU, OMER, PEUGEOT, PIAGGIO, POLINI, PUCH, RIEJU, RIXE, RIZZATO, ROYAL ENFIELD, S.I.S., SACHS, SPARTA, STARFLITE, TESTI, TORROT, VELOSOLEX, WINKING, YAMAHA, ZÜNDAPP
B6L	HARLEY-DAVIDSON
B7ES	B.S.A. BENELLI, CARABELA, GILERA, KAWASAKI, LAMBRETTA, MALAGUTI, MINARELLI, MONTESA, MOTO GUZZI, PIAGGIO, SUZUKI, YAMAHA
B7HS	ADLER, ATALA, ATK, BENELLI, BETA, BOOM TRIKE, BULTACO, CAGIVA, CASAL, DERBI, DKW, DUCATI, DÜRRKOPP, FANTIC, G.A.C. MobyLe., HERCULES, ITALJET, KAWASAKI, KREIDLER, KTM, LEM, MBK, MONDIAL, MONTESA, MOTOR HISPANIA, NSU, PEUGEOT, PIAGGIO, REGENT, RIXE, S.I.S., SACHS, SUZUKI, TOMOS, TORROT, YAMAHA, ZÜNDAPP
B8EG	FANTIC, HUSQVARNA, YAMAHA

B8ES	ALFER, ATK, B.S.A. BENELLI, BETA, BULTACO, CAGIVA, CARABELA, DERBI, FANTIC, GILERA, HARLEY-DAVIDSON, HM RACING, KAWASAKI, LAVERDA, MBK, MINARELLI, MONTESA, MOTO GUZZI, MOTO KOSMOS, MV AGUSTA, OSSA, PEUGEOT, PIAGGIO, PUCH, RIZZATO, ROYAL ENFIELD, SUZUKI, TESTI, TRIUMPH, YAMAHA, ZÜNDAPP
B8HS	ADLER, BMW, CAGIVA, CASAL, DAELIM, DERBI, DKW, DÜRRKOPP, FITE (LEM), GAS GAS, HERCULES, HM RACING, JAWA, KAWASAKI, KREIDLER, KTM, MALAGUTI, MBK, MONDIAL, MONTESA, MZ, MZ (TR), NSU, PEUGEOT, PUCH, RIXE, S.I.S., SACHS, SIMONINI IMEA, SIMSON, SUZUKI, TESTI, YAMAHA, ZÜNDAPP
B9EG	APRILIA, BULTACO, CAGIVA, CCM, FANTIC, GILERA, HUSQVARNA, KAWASAKI, KTM, TM, YAMAHA
B9ES	APRILIA, BETA, BLATA, BULTACO, CAGIVA, DERBI, GILERA, HARLEY-DAVIDSON, HERCULES, HUSQVARNA, KTM, MAICO, MALAGUTI, MONTESA, MOTO GUZZI, MOTO KOSMOS, OSSA, PIAGGIO, PUCH, SACHS, YAMAHA
B9HCS	KTM
B9HS	BULTACO, CASAL, KAWASAKI, KTM, PUCH, SIMSON
BCP7ET	BMW
BCPR6ET	MZ
BKR5E	ARGO, POLARIS
BKR6ES	POLARIS
BKR7E	POLARIS
BKR7EKC	BMW, G+G
BKR7EKC + DCPR8EKC	BMW
BMR2A-10	JOHN DEERE
BMR4A	ARGO
BP4H	SUZUKI



BP4HS	URAL, YAMAHA
BP5ES	APRILIA, BULTACO, CCM, GAS GAS, HARLEY-DAVIDSON, MECATECNO, MERLIN, MONTESA, OSSA, SCORPA, SHERCO, SWM, ZÜNDAPP
BP5ESA	BOOM TRIKE
BP5HS	BAJAJ, CARABELA
BP6ES	BMW, CARTER, DNEPR, KTM, LEM, MBK, MOTO GUZZI, MOTO-SPEZIAL, SANGLAS, SUZUKI, YAMAHA
BP6HS	BAJAJ, BOSS, CAGIVA, DNEPR, HYOSUNG, ISCH, ITALJET, KTM, LECSON, MOTOTECHNIKA, MZ, PEUGEOT, PGO, SACHS, STEFFEN, SUZUKI, T.G.M. BIMOTA, TGB, YAMAHA
BP6HS-10	YAMAHA
BP6HSA	KUANG YANG
BP7ES	BETA, BMW, JCM, KAWASAKI, MOTO GUZZI, MOTO MORINI, SUZUKI, YAMAHA
BP7HS	BLANEY, CAGIVA, CCF, DRR, DUCATI, FANTIC, GARELLI, HERCULES, HERKULES, HYOSUNG, ISCH, ITALJET, KINETIC, MARS, MBK, MINSK, MOTOTECHNIKA, PGO, SACHS, SHE LUNG, TOKAIDO, TRAILBLAZER, URAL AMERICA, YAMAHA, ZID
BP7HS-10	MBK, YAMAHA
BP8ES	LML- VESPA, MOTO GUZZI, MOTO MORINI, MÜNCH, PIAGGIO, SUZUKI, YAMAHA
BPM6A	SV
BPR4HS	KAWASAKI, SUZUKI
BPR5ES	BULTACO, GAS GAS, JOHN DEERE, KAWASAKI, MONTESA, TITAN
BPR5ES-11	AMERICAN IRON HORSE, BIG DOG, HARLEY-DAVIDSON, INDIAN, TITAN
BPR5HS	BAJAJ, HONDA
BPR6ES	GAS GAS, KAWASAKI, MOTO GUZZI, YAMAHA

BPR6HS	ATALA, HONDA, ITALJET, MALAGUTI, PEUGEOT, SACHS, SASY, SIAM, SIAMOTO, SUZUKI, YAMAHA
BPR6HSA	HONDA
BPR7ES	MONTESA, YAMAHA
BPR7HS	AEON, BAROSSA MOTOR, BOMBARDIER, BSM, DAREN, DINLI, DUCATI, E-TON, FOX, GARELLI, HERKULES, KREIDLER, MANCO, MBK, PEGASUS, PGO, POLARIS, REX, SACHS, SUZUKI, TGB, UNITED MOTORS, YAMAHA
BPR8ES	KAWASAKI, PIAGGIO, YAMAHA
BPR8HS	APRILIA, ITALJET, YAMAHA
BR10EG	APRILIA, HONDA, KTM
BR10ES	DERBI, KAWASAKI, SUZUKI
BR2LM	CARTER, TRAILSPOORT
BR4LM	CARTER
BR5HS	SACHS
BR6ES	BRISTER, CARTER, HONDA, KAWASAKI, ROYAL ENFIELD, YAMAHA
BR6HS	COSSACK, HONDA, MANCO, PIAGGIO, ROYAL ENFIELD, SOLO, YAMAHA
BR6HSA	HONDA
BR7ES	CPI, KAWASAKI, KTM, PIAGGIO
BR7HS	APRILIA, BENELLI, BETA, BUFFALO, DUCATI, HONDA, ITALJET, KTM, K-ZWO, LEM, MACAL, MALAGUTI, MBK, MOTRON, MZ, PEUGEOT, PIAGGIO, SACHS, SOLO, SUZUKI, YAMAHA
BR8ECM	KTM
BR8EG	GAS GAS, HONDA, HUSQVARNA, KTM, TM
BR8ES	ALFER, APRILIA, DERBI, HONDA, HRD, KAWASAKI, MOTO GUZZI, MSA, PEUGEOT, PIAGGIO, POLARIS, RIEJU, ROYAL ENFIELD, SACHS, SHERCO- HRD, SUZUKI, YAMAHA



BR8HS	APRILIA, BENELLI, BETA, DERBI, HONDA, ITALJET, KTM, LEM, MALAGUTI, MBK, PEUGEOT, RENAULT SPORT, SACHS, UNISOM, UNITED MOTORS, YAMAHA
BR8HSA	ACCESS, BS VILLA, CAGIVA, CPI, DAELIM, GARELLI, HYOSUNG, KOLPIN, KYMCO, MSA, SAN YANG, SYM, VILLA BS
BR9ECM	YAMAHA
BR9ECS	BOMBARDIER, HONDA
BR9EG	CAGIVA, HONDA, HUSQVARNA, YAMAHA
BR9ES	APRILIA, CAGIVA, DERBI, GILERA, HONDA, HUSQVARNA, ITALJET, KAWASAKI, MBK, MOTOR HISPANIA, PIAGGIO, RIEJU, SACHS, SUZUKI, YAMAHA
BR9HS	GARELLI, HONDA, YAMAHA
C6HSA	KAWASAKI, YAMAHA
C7E	BENELLI, HUSQVARNA
C7HSA	DINLI, HERKULES, KYMCO, K-ZWO, PGO, SACHS, SAN YANG, SIAMOTO, SYM, TNG, VINSON, XING FU, YAMAHA
C8E	HUSABERG, NORTON
C8EH-9	DAELIM
C8HSA	MOTO GUZZI
CPR8E	APRILIA, GILERA, HUSQVARNA, PIAGGIO
CR10EK	SUZUKI, YAMAHA
CR6E	ARCTIC CAT, SUZUKI
CR6HS	HONDA, YAMAHA
CR6HSA	HONDA, MIDWEST, PANDA, YAMAHA
CR7E	APRILIA, ARCTIC CAT, CAGIVA, ITALJET, KAWASAKI, MBK, MZ, PIAGGIO, SUZUKI, YAMAHA
CR7EB	HUSQVARNA, PEUGEOT, PIAGGIO
CR7EKA	PEUGEOT



CR7EKB	APRILIA, PIAGGIO, SYM
CR7HS	AEON, HONDA, YAMAHA
CR7HSA	AEON, BOMBARDIER, DAZON, ERING, GARELLI, HONDA, KREIDLER, KYMCO, MALAGUTI, PEGASUS, REX, RIEJU, SACHS, SUNDIRO, YAMAHA
CR8E	APRILIA, ARCTIC CAT, BENELLI, BOMBARDIER, CAGIVA, DAZON, GAS GAS, HERKULES, HIGHLAND, HYOSUNG, ITALJET, KAWASAKI, KYMCO, MBK, MZ, PEUGEOT, SUZUKI, SYM, TM, YAMAHA
CR8EB	APRILIA, BENELLI, BMW, GILERA, HUSQVARNA, KAWASAKI, MALAGUTI, PIAGGIO
CR8EH-9	DAELIM, HONDA, HYOSUNG
CR8EH-9S	HONDA
CR8EK	CAGIVA, KTM, SUZUKI, VOR
CR8HS	HONDA, KARCHER
CR8HSA	AEON, KAWASAKI, SYM
CR9E	ALFER, BENELLI, BIMOTA, DERBI, KAWASAKI, PIAGGIO, SUZUKI, YAMAHA
CR9EB	GILERA, HRD, MV AGUSTA, PIAGGIO, RENAULT SPORT
CR9EH-9	HONDA
CR9EK	BETA, BIMOTA, CANNONDALE, KAWASAKI, SUZUKI, TRIUMPH, VERTEMATI, YAMAHA
CR9EKB	KTM, MV AGUSTA
D7EA	BMW, SUZUKI, YAMAHA
D8EA	APRILIA, ATK, BENELLI, BMW, GILERA, JAWA, KAWASAKI, KTM, MOTO GUZZI, MZ, SUZUKI, YAMAHA
D9EA	KAWASAKI, LAVERDA, SUZUKI
DCPR6E	HONDA
DCPR7E	AMERICAN IRON HORSE, BIG DOG, BMW, BUELL, HARLEY-DAVIDSON, TITAN



DCPR8E	EAT RACING, EATV, HUSABERG, KTM, BMW, BOMBARDIER, DUCATI, JOHN DEERE, POLARIS
DCPR8EKC	BMW
DCPR9E	APRILIA, BUELL
DP7EA-9	SUZUKI
DP8EA-9	CAGIVA, YAMAHA
DP9EA-9	GILERA, KTM, PUCH
DPR5EA-9	KAWASAKI
DPR6EA-9	HONDA, KAWASAKI
DPR7EA-9	HARLEY-DAVIDSON, HONDA, KAWASAKI, KYMCO, SUZUKI, YAMAHA
DPR8EA-9	BIMOTA, CAGIVA, DERBI, DUCATI, GILERA, HONDA, KAWASAKI, KTM, LAVERDA, SUZUKI, TRIUMPH, YAMAHA
DPR8Z	HONDA
DPR9EA-9	CAGIVA, HONDA, KAWASAKI, LAVERDA, MZ, SUZUKI, YAMAHA
DPR9Z	HONDA
DR7EA	ARCTIC CAT, BMW, MIDWEST, YAMAHA
DR7ES	HONDA, KAWASAKI, SUZUKI, YAMAHA
DR8EA	APRILIA, BAROSSA MOTOR, BETA, BIMOTA, BOMBARDIER, CCM, DAREN, HERKULES, HONDA, HYOSUNG, ITALJET, JAWA, KAWASAKI, KREIDLER, KTM, KYMCO, REX, SUZUKI, TRAILBLAZER, YAMAHA
DR8EB	BMW
DR8ES	AJP, HONDA, KAWASAKI, SUZUKI
DR8ESL	BIMOTA, HONDA, KAWASAKI, SUZUKI, YAMAHA
DR9EA	KAWASAKI, KTM
ER8EH-N	HONDA
ER9EH	HONDA

JR9B	SUZUKI
JR9C	SUZUKI
KR9CI	BMW
PTR5A-13	BOOM TRIKE
R0045J-10	HUSQVARNA, MV AGUSTA
R2270-9	DUCATI
R2349-9	DUCATI
R6179A-105P	YAMAHA
R6252K-105	KAWASAKI
R6918B-8	KTM
R7234-10	KTM
R7376-10	YAMAHA
XR5	HARLEY-DAVIDSON
ZGR5A	CUB CADET
ZMR7AP	APRILIA



ACCESS	BR8HSA
ADLER	B7HS, B8HS
AEON	BPR7HS, CR7HS, CR7HSA, CR8HSA
AJP	DR8ES
ALFER	B8ES, BR8ES, CR9E
AMERICAN IRON HORSE	BPR5ES-11, DCPR7E
APRILIA	B10EG, B9EG, B9ES, BP5ES, BPR8HS, BR10EG, BR7HS, BR8ES, BR8HS, BR9ES, CPR8E, CR7E, CR7EKB, CR8E, CR8EB, D8EA, DCPR9E, DR8EA
ARCTIC CAT	CR6E, CR7E, CR8E, DR7EA
ARGO	BKR5E, BMR4A
ATALA	B7HS, BPR6HS
ATK	B7HS, B8ES, D8EA
B.S.A	B7ES, B8ES
BAJAJ	B6HS, BP5HS, BP6HS, BPR5HS
BAROSSA MOTOR	BPR7HS, DR8EA
BATAVUS	B6HS
BENELLI	B6HS, B7ES, B7HS, B8ES, BR7HS, BR8HS, C7E, CR8E, CR8EB, CR9E, D8EA
BETA	B10ES, B6ES, B7HS, B8ES, B9ES, BP7ES, BR7HS, BR8HS, CR9EK, DR8EA
BIG DOG	BPR5ES-11, DCPR7E
BIMOTA	CR9E, CR9EK, DPR8EA-9, DR8EA, DR8ESL
BLANEY	BP7HS
BLATA	B9ES
BMW	B6HS, B8HS, BCP7ET, BKR7EKC, BKR7EKC + DCPR8EKC, BP6ES, BP7ES, CR8EB, D7EA, D8EA, DCPR7E, DCPR8E, DCPR8EKC, DR7EA, DR8EB
BOMBARDIER	BPR7HS, BR9ECS, CR7HSA, CR8E, DCPR8E, DR8EA

BOOM TRIKE	B6HS, B7HS, BP5ESA, PTR5A-13
BOSS	BP6HS
BRISTER	BR6ES
BS VILLA	BR8HSA
BSM	BPR7HS
BUELL	DCPR7E, DCPR9E
BUFFALO	BR7HS
BULTACO	B5ES, B5HS, B6HS, B7HS, B8ES, B9EG, B9ES, B9HS, BP5ES, BPR5ES
CAGIVA	B7HS, B8ES, B8HS, B9EG, B9ES, BP6HS, BP7HS, BR8HSA, BR9EG, BR9ES, CR7E, CR8E, CR8EK, DP8EA-9, DPR8EA-9, DPR9EA-9
CANNONDALE	CR9EK
CARABELA	B6ES, B6HS, B7ES, B8ES, BP5HS
CARTER	BP6ES, BR2LM, BR4LM, BR6ES
CASAL	B7HS, B8HS, B9HS
CCF	BP7HS
CCM	B9EG, BP5ES, DR8EA
COSSACK	BR6HS
CPI	BR7ES, BR8HSA
CUB CADET	ZGR5A
CZ	B6HS
DAELIM	B8HS, BR8HSA, C8EH-9, CR8EH-9
DAREN	BPR7HS, DR8EA
DAZON	CR7HSA, CR8E
DERBI	B7HS, B8ES, B8HS, B9ES, BR10ES, BR8ES, BR8HS, BR9ES, CR9E, DPR8EA-9
DINLI	BPR7HS, C7HSA
DKW	B6HS, B7HS, B8HS



DNEPR	BP6ES, BP6HS
DRR	BP7HS
DUCATI	B6HS, B7HS, BP7HS, BPR7HS, BR7HS, DCPR8E, DPR8EA-9, R2270-9, R2349-9
DUCCSON	B6HS
DÜRRKOPP	B7HS, B8HS
EAT RACING	DCPR8E
EATV	DCPR8E
ERING	B6HS, CR7HSA
E-TON	BPR7HS
FANTIC	B5HS, B6HS, B7HS, B8EG, B8ES, B9EG, BP7HS
FITE (LEM)	B8HS
FOX	BPR7HS
G.A.C. Mobyile.	B6HS, B7HS
G+G	BKR7EKC
GARELLI	B10ES, B6HS, BP7HS, BPR7HS, BR8HSA, BR9HS, CR7HSA
GAS GAS	B10EGV, B8HS, BP5ES, BPR5ES, BPR6ES, BR8EG, CR8E
GILERA	B5HS, B6ES, B6HS, B7ES, B8ES, B9EG, B9ES, BR9ES, CPR8E, CR8EB, CR9EB, D8EA, DP9EA-9, DPR8EA-9
GIMSON	B5HS
HARLEY-DAVIDSON	B6L, B8ES, B9ES, BP5ES, BPR5ES-11, DCPR7E, DPR7EA-9, XRS
HERCULES	B5HS, B6HS, B7HS, B8HS, B9ES, BP7HS
HERKULES	BP7HS, BPR7HS, C7HSA, CR8E, DR8EA
HIGHLAND	CR8E
HM RACING	B8ES, B8HS

HONDA	BPR5HS, BPR6HS, BPR6HSA, BR10EG, BR6ES, BR6HS, BR6HSA, BR7HS, BR8EG, BR8ES, BR8HS, BR9ECS, BR9EG, BR9ES, BR9HS, CR6HS, CR6HSA, CR7HS, CR7HSA, CR8EH-9, CR8HS, CR9EH-9, DCPR6E, DPR6EA-9, DPR7EA-9, DPR8EA-9, DPR8Z, DPR9EA-9, DPR9Z, DR7ES, DR8EA, DR8ES, DR8ESL, ER8EH-N, ER9EH
HRD	BR8ES, CR9EB
HUSABERG	C8E, DCPR8E
HUSQVARNA	B6HS, B8EG, B9EG, B9ES, BR8EG, BR9EG, BR9ES, C7E, CPR8E, CR7EB, CR8EB, R0045J-10
HYOSUNG	BP6HS, BP7HS, BR8HSA, CR8E, CR8EH-9, DR8EA
INDIAN	BPR5ES-11
ISCH	BP6HS, BP7HS
ITALJET	B7HS, BP6HS, BP7HS, BPR6HS, BPR8HS, BR7HS, BR8HS, BR9ES, CR7E, CR8E, DR8EA
JAWA	B6HS, B8HS, D8EA, DR8EA
JCM	BP7ES
JOHN DEERE	BMR2A-10, BPR5ES, DCPR8E
KARCHER	CR8HS
KAWASAKI	B6ES, B7ES, B7HS, B8ES, B8HS, B9EG, B9HS, BP7ES, BPR4HS, BPR5ES, BPR6ES, BPR8ES, BR10ES, BR6ES, BR7ES, BR8ES, BR9ES, C6HSA, CR7E, CR8E, CR8EB, CR8HSA, CR9E, CR9EK, D8EA, D9EA, DPR5EA-9, DPR6EA-9, DPR7EA-9, DPR8EA-9, DPR9EA-9, DR7ES, DR8EA, DR8ES, DR8ESL, DR9EA, R6252K-105
KINETIC	BP7HS
KOLPIN	BR8HSA
KREIDLER	B6HS, B7HS, B8HS, BPR7HS, CR7HSA, DR8EA
KTM	B10EG, B5HS, B6HS, B7HS, B8HS, B9EG, B9ES, B9HCS, B9HS, BP6ES, BP6HS, BR10EG, BR7ES, BR7HS, BR8ECM, BR8EG, BR8HS, CR8EK, D8EA, DCPR8E, DP9EA-9, DPR8EA-9, DR8EA, DR9EA, R6918B-8, R7234-10



KUANG YANG	BP6HSA
KYMCO	B6HS, BR8HSA, C7HSA, CR7HSA, CR8E, DPR7EA-9, DR8EA
K-ZWO	BR7HS, C7HSA
LAMBRETTA	B6HS, B7ES
LAVERDA	B8ES, D9EA, DPR8EA-9, DPR9EA-9
LECSO	BP6HS
LEM	B5HS, B6ES, B7HS, BP6ES, BR7HS, BR8HS
LML- VESPA	BP8ES
MACAL	BR7HS
MAICO	B9ES
MALAGUTI	B6HS, B7ES, B8HS, B9ES, BPR6HS, BR7HS, BR8HS, CR7HSA, CR8EB
MANCO	BPR7HS, BR6HS
MARS	B5HS, BP7HS
MBK	B6HS, B7HS, B8ES, B8HS, BP6ES, BP7HS, BP7HS-10, BPR7HS, BR7HS, BR8HS, BR9ES, CR7E, CR8E
MECATECNO	B6HS, BP5ES
MERLIN	BP5ES
MIDWEST	CR6HSA, DR7EA
MINARELLI	B6ES, B6HS, B7ES, B8ES
MINSK	BP7HS
MONDIAL	B7HS, B8HS
MONTESA	B6HS, B7ES, B7HS, B8ES, B8HS, B9ES, BP5ES, BPR5ES, BPR7ES
MOTO GEROSA	B6ES, B6HS
MOTO GUZZI	B6HS, B7ES, B8ES, B9ES, BP6ES, BP7ES, BP8ES, BPR6ES, BR8ES, C8HSA, D8EA
MOTO KOSMOS	B8ES, B9ES

MOTO MORINI	BP7ES, BP8ES
MOTOR HISPANIA	B6ES, B6HS, B7HS, BR9ES
MOTO-SPEZIAL	BP6ES
MOTOTECHNIKA	BP6HS, BP7HS
MOTRON	BR7HS
MSA	BR8ES, BR8HSA
MÜNCH	BP8ES
MV AGUSTA	B8ES, CR9EB, R0045J-10
MZ	B8HS, BCPR6ET, BP6HS, BR7HS, CR7E, CR8E, D8EA, DPR9EA-9
MZ (TR)	B8HS
NORTON	C8E
NSU	B6HS, B7HS, B8HS
OMER	B5HS, B6HS
OSSA	B8ES, B9ES, BP5ES
PANDA	CR6HSA
PEGASUS	BPR7HS, CR7HSA
PEUGEOT	B5HS, B6HS, B7HS, B8ES, B8HS, BP6HS, BPR6HS, BR7HS, BR8ES, BR8HS, CR7EB, CR8E
PGO	BP6HS, BP7HS, BPR7HS, C7HSA
PIAGGIO	B5HS, B6ES, B6HS, B7ES, B7HS, B8ES, B9ES, BP8ES, BPR8ES, BR6HS, BR7ES, BR7HS, BR8ES, BR9ES, CPR8E, CR7E, CR7EB, CR7EKB, CR8EB, CR9E, CR9EB
POLARIS	BKR5E, BKR6ES, BKR7E, BPR7HS, BR8ES, DCPR8E
POLINI	B6HS
PUCH	B4H, B5HS, B6HS, B8ES, B8HS, B9ES, B9HS, DP9EA-9
REGENT	B7HS



RENAULT SPORT	BR8HS, CR9EB
REX	BPR7HS, CR7HSA, DR8EA
RIEJU	B5HS, B6ES, B6HS, BR8ES, BR9ES, CR7HSA
RIXE	B4H, B6HS, B7HS, B8HS
RIZZATO	B5HS, B6HS, B8ES
ROYAL ENFIELD	B6HS, B8ES, BR6ES, BR6HS, BR8ES
S. I. S.	B6HS, B7HS, B8HS
SACHS	B5HS, B6HS, B7HS, B8HS, B9ES, BP6HS, BP7HS, BPR6HS, BPR7HS, BR5HS, BR7HS, BR8ES, BR8HS, BR9ES, C7HSA, CR7HSA
SAN YANG	BR8HSA, C7HSA
SANGLAS	BP6ES
SASY	BPR6HS
SCORPA	BP5ES
SHE LUNG	BP7HS
SHERCO	BP5ES
SHERCO- HRD	BR8ES
SIAM	BPR6HS
SIAMOTO	BPR6HS, C7HSA
SIMONINI IMEA	B10EGV, B8HS
SIMSON	B8HS, B9HS
SOLO	BR6HS, BR7HS
SPARTA	B6HS
STARFLITE	B6HS
STEFFEN	BP6HS
SUNDIRO	CR7HSA

SUZUKI	B7ES, B7HS, B8ES, B8HS, BP4H, BP6ES, BP6HS, BP7ES, BP8ES, BPR4HS, BPR6HS, BPR7HS, BR10ES, BR7HS, BR8ES, BR9ES, CR10EK, CR6E, CR7E, CR8E, CR8EK, CR9E, CR9EK, D7EA, D8EA, D9EA, DP7EA-9, DPR7EA-9, DPR8EA-9, DPR9EA-9, DR7ES, DR8EA, DR8ES, DR8ESL, JR9B, JR9C
SV	BPM6A
SWM	BP5ES
SYM	BR8HSA, C7HSA, CR7EKB, CR8E, CR8HSA
T. G. M. BIMOTA	BP6HS
TESTI	B5HS, B6ES, B6HS, B8ES, B8HS
TGB	BP6HS, BPR7HS
TITAN	BPR5ES, BPR5ES-11, DCPR7E
TM	B9EG, BR8EG, CR8E
TNG	C7HSA
TOKAIDO	BP7HS
TOMOS	B7HS
TORPADO	B5HS
TORROT	B5HS, B6HS, B7HS
TRAILBLAZER	BP7HS, DR8EA
TRAILSPORT	BR2LM
TRIUMPH	B8ES, CR9EK, DPR8EA-9
UNISOM	BR8HS
UNITED MOTORS	BPR7HS, BR8HS
URAL	BP4HS
URAL AMERICA	BP7HS
VELOSOLEX	B4H, B6HS
VERTEMATI	CR9EK
VILLA BS	BR8HSA



Order-No.

201	B8ES	1015
202	B9ES	2108
203	B6HS	2417
204	B7HS	2792
205	B8HS	3014
206	BP7ES	3355
207	BR8ES	3639
208	BR9ES	3988
209	BRGHS	4200
210	BRGHS A	4461
211	BR7HS	4737
212	BR8HS	4915
213	BPR8ES	5170
214	BPR6HS	5343
215	BPR7HS	5541
216	D8EA	1117
217	DR8ES	2204
218	DR8ESL	2556
219	DR9EA	2871
220	DPR7EA-9	3146
221	DPR8EA-9	3483
222	DPR9EA-9	3717
223	CR6HS	4042
224	JR9B	4297
225	CR7E	4509
226	CR8E	4854
227	CR9E	5006
228	CR8EH-9	5219
229	CR9EH-9	5454
230	CR9EK	5600

Quick-No.



Quick-No.



ADLER	204, 205
AEON	215
AJP	217
ALFER	201, 207, 227
APRILIA	202, 207, 208, 211, 212, 216, 225, 226
ARCTIC CAT	225, 226
ATALA	204, 214
ATK	201, 204, 216
B. S. A	201
BAJAJ	203
BAROSSA MOTOR	215
BATAVUS	203
BENELLI	201, 203, 204, 211, 212, 216, 226, 227
BETA	201, 202, 204, 206, 211, 212, 230
BIMOTA	218, 221, 227, 230
BLATA	202
BMW	203, 205, 206, 216
BOMBARDIER	215, 226
BOOM TRIKE	203, 204
BSM	215
BUFFALO	211
BULTACO	201, 202, 203, 204
CAGIVA	201, 202, 204, 205, 208, 221, 222, 225, 226
CANNONDALE	230
CARABELA	201, 203
CARTER	310
CASAL	204, 205

Quick-No.



Quick-No.



COSSACK	209
CZ	203
DAELIM	205, 228
DAREN	215
DAZON	226
DERBI	201, 202, 204, 205, 207, 208, 212, 221, 227
DINLI	215
DKW	203, 204, 205
DUCATI	203, 204, 211, 215, 221
DUCSON	203
DÜRRKOPP	204, 205
ERING	203
E-TON	215
FANTIC	201, 203, 204
FITE (LEM)	205
FOX	215
G.A.C. Mobyte.	203, 204
GARELLI	203, 215
GAS GAS	205, 226
GILERA	201, 202, 203, 208, 216, 221
HARLEY-DAVIDSON	201, 202, 220
HERCULES	202, 203, 204, 205
HERKULES	215, 226
HIGHLAND	226
HM RACING	201, 205
HONDA	207, 208, 209, 210, 211, 212, 214, 217, 218, 220, 221, 222, 223, 227, 228, 229



Quick-No.



HRD	207
HUSQVARNA	202, 203, 208
HYOSUNG	226, 228
ITALJET	204, 208, 211, 212, 214, 225, 226
JAWA	203, 205, 216
JCM	206
KAWASAKI	201, 204, 205, 206, 207, 208, 213, 216, 217, 218, 219, 220, 221, 222, 225, 226, 227, 230
KREIDLER	203, 204, 205, 215
KTM	202, 203, 204, 205, 211, 212, 216, 219, 221
KYMCO	203, 220, 226
K-ZWO	211
LAMBRETTA	203
LAVERDA	201
LEM	204, 211, 212
MACAL	211
MAICO	202
MALAGUTI	202, 203, 205, 211, 212, 214
MANCO	209, 215
MBK	201, 203, 204, 205, 208, 211, 212, 215, 225, 226
MECATECNO	203
MINARELLI	201, 203
MONDIAL	204, 205
MONTESA	201, 202, 203, 204, 205
MOTO GEROSA	203
MOTO GUZZI	201, 202, 203, 206, 207, 216
MOTO KOSMOS	201, 202

Quick-No.



Quick-No.



Quick-No.



MOTO MORINI	206
MOTOR HISPANIA	203, 204, 208
MOTRON	211
MSA	207
MV AGUSTA	201
MZ	205, 211, 216, 222, 225, 226
MZ (TR)	205
NSU	203, 204, 205
OMER	203
OSSA	201, 202
PEGASUS	215
PEUGEOT	201, 203, 204, 205, 207, 211, 212, 214, 226
PGO	215
PIAGGIO	201, 202, 203, 204, 207, 208, 209, 211, 213, 225, 227
POLARIS	207, 215
POLINI	203
PUCH	201, 202, 203, 205
REGENT	204
RENAULT SPORT	212
REX	215
RIEJU	203, 207, 208
RIXE	203, 204, 205
RIZZATO	201, 203
ROYAL ENFIELD	201, 203, 207, 209
S.I.S.	203, 204, 205
SACHS	202, 203, 204, 205, 207, 208, 211, 212, 214, 215

SASY	214
SHERCO- HRD	207
SIAM	214
SIAMOTO	214
SIMONINI IMEA	205
SIMSON	205
SOLO	209, 211
SPARTA	203
STARFLITE	203
SUZUKI	201, 204, 205, 206, 207, 208, 211, 214, 215, 216, 217, 218, 220, 221, 222, 224, 225, 226, 227, 230
SYM	226
TESTI	201, 203, 205
TGB	215
TM	226
TOMOS	204
TORROT	203, 204
TRAILSPORT	310
TRIUMPH	201, 221, 230
UNISOM	212
UNITED MOTORS	212, 215
VELOSOLEX	203
VERTEMATI	230
WINKING	203
YAMAHA	201, 202, 203, 204, 205, 206, 207, 208, 209, 211, 212, 213, 214, 215, 216, 218, 220, 221, 222, 223, 225, 226, 227, 230
ZÜNDAPP	201, 203, 204, 205

Quick-No.



Quick-No.

201	ALFER, ATK, B.S.A, BENELLI, BETA, BULTACO, CAGIVA, CARABELA, DERBI, FANTIC, GILERA, HARLEY-DAVIDSON, HM RACING, KAWASAKI, LAVERDA, MBK, MINARELLI, MONTESA, MOTO GUZZI, MOTO KOSMOS, MV AGUSTA, OSSA, PEUGEOT, PIAGGIO, PUCH, RIZZATO, ROYAL ENFIELD, SUZUKI, TESTI, TRIUMPH, YAMAHA, ZÜNDAPP
202	APRILIA, BETA, BLATA, BULTACO, CAGIVA, DERBI, GILERA, HARLEY-DAVIDSON, HERCULES, HUSQVARNA, KTM, MAICO, MALAGUTI, MONTESA, MOTO GUZZI, MOTO KOSMOS, OSSA, PIAGGIO, PUCH, SACHS, YAMAHA
203	BAJAJ, BATAVUS, BENELLI, BMW, BOOM TRIKE, BULTACO, CARABELA, CZ, DKW, DUCATI, DUCSON, ERING, FANTIC, G.A.C. Mobyte., GARELLI, GILERA, HERCULES, HUSQVARNA, JAWA, KREIDLER, KTM, KYMCO, LAMBRETTA, MALAGUTI, MBK, MECATECNO, MINARELLI, MONTESA, MOTO GEROSA, MOTO GUZZI, MOTOR HISPANIA, NSU, OMER, PEUGEOT, PIAGGIO, POLINI, PUCH, RIEJU, RIXE, RIZZATO, ROYAL ENFIELD, S.I.S., SACHS, SPARTA, STARFLITE, TESTI, TORROT, VELOSOLEX, WINKING, YAMAHA, ZÜNDAPP
204	ADLER, ATALA, ATK, BENELLI, BETA, BOOM TRIKE, BULTACO, CAGIVA, CASAL, DERBI, DKW, DUCATI, dürrkopp, FANTIC, G.A.C. Mobyte., HERCULES, ITALJET, KAWASAKI, KREIDLER, KTM, LEM, MBK, MONDIAL, MONTESA, MOTOR HISPANIA, nsu, PEUGEOT, PIAGGIO, REGENT, RIXE, S.I.S., SACHS, SUZUKI, TOMOS, TORROT, YAMAHA, ZÜNDAPP
205	ADLER, BMW, CAGIVA, CASAL, DAELIM, DERBI, DKW, dürrkopp, FITE (LEM), GAS GAS, HERCULES, HM RACING, JAWA, KAWASAKI, KREIDLER, KTM, MALAGUTI, MBK, MONDIAL, MONTESA, MZ, MZ (TR), NSU, PEUGEOT, PUCH, RIXE, S.I.S., SACHS, SIMONINI IMEA, SIMSON, SUZUKI, TESTI, YAMAHA, ZÜNDAPP
206	BETA, BMW, JCM, KAWASAKI, MOTO GUZZI, MOTO MORINI, SUZUKI, YAMAHA
207	ALFER, APRILIA, DERBI, HONDA, HRD, KAWASAKI, MOTO GUZZI, MSA, PEUGEOT, PIAGGIO, POLARIS, RIEJU, ROYAL ENFIELD, SACHS, SHERCO- HRD, SUZUKI, YAMAHA
208	APRILIA, CAGIVA, DERBI, GILERA, HONDA, HUSQVARNA, ITALJET, KAWASAKI, MBK, MOTOR HISPANIA, PIAGGIO, RIEJU, SACHS, SUZUKI, YAMAHA
209	COSSACK, HONDA, MANCO, PIAGGIO, ROYAL ENFIELD, SOLO, YAMAHA
210	HONDA



Quick-No.

211	APRILIA, BENELLI, BETA, BUFFALO, DUCATI, HONDA, ITALJET, KTM, K-ZWO, LEM, MACAL, MALAGUTI, MBK, MOTRON, MZ, PEUGEOT, PIAGGIO, SACHS, SOLO, SUZUKI, YAMAHA
212	APRILIA, BENELLI, BETA, DERBI, HONDA, ITALJET, KTM, LEM, MALAGUTI, MBK, PEUGEOT, RENAULT SPORT, SACHS, UNISOM, UNITED MOTORS, YAMAHA
213	KAWASAKI, PIAGGIO, YAMAHA
214	ATALA, HONDA, ITALJET, MALAGUTI, PEUGEOT, SACHS, SASY, SIAM, SIAMOTO, SUZUKI, YAMAHA
215	AEON, BAROSSA MOTOR, BOMBARDIER, BSM, DAREN, DINLI, DUCATI, E-TON, FOX, GARELLI, HERKULES, KREIDLER, MANCO, MBK, PEGASUS, PGO, POLARIS, REX, SACHS, SUZUKI, TGB, UNITED MOTORS, YAMAHA
216	APRILIA, ATK, BENELLI, BMW, GILERA, JAWA, KAWASAKI, KTM, MOTO GUZZI, MZ, SUZUKI, YAMAHA
217	AJP, HONDA, KAWASAKI, SUZUKI
218	BIMOTA, HONDA, KAWASAKI, SUZUKI, YAMAHA
219	KAWASAKI, KTM
220	HARLEY-DAVIDSON, HONDA, KAWASAKI, KYMCO, SUZUKI, YAMAHA
221	BIMOTA, CAGIVA, DERBI, DUCATI, GILERA, HONDA, KAWASAKI, KTM, SUZUKI, TRIUMPH, YAMAHA
222	CAGIVA, HONDA, KAWASAKI, MZ, SUZUKI, YAMAHA
223	HONDA, YAMAHA
224	SUZUKI
225	APRILIA, ARCTIC CAT, CAGIVA, ITALJET, KAWASAKI, MBK, mZ, PIAGGIO, SUZUKI, YAMAHA
226	APRILIA, ARCTIC CAT, BENELLI, BOMBARDIER, CAGIVA, DAZON, GAS GAS, HERKULES, Highland, HYOSUNG, ITALJET, KAWASAKI, KYMCO, MBK, MZ, PEUGEOT, SUZUKI, SYM, TM, YAMAHA
227	ALFER, BENELLI, BIMOTA, DERBI, HONDA, KAWASAKI, PIAGGIO, SUZUKI, YAMAHA
228	DAELIM, HONDA, HYOSUNG



BCPR5EIX-11	AMERICAN IRON HORSE
BCPR7EIX	BMW
BKR5EIX	ARGO, POLARIS
BKR6EIX	POLARIS
BKR7EIX	BMW, G+G, POLARIS
BKR7EIX + DCPR8EIX	BMW
BPR5EIX	APRILIA, BOOM TRIKE, BULTACO, CCM, GAS GAS, HARLEY-DAVIDSON, JOHN DEERE, KAWASAKI, MECATECNO, MERLIN, MONTESA, OSSA, SCORPA, SHERCO, SWM, TITAN, ZÜNDAPP
BPR5EIX-11	BIG DOG, HARLEY-DAVIDSON, INDIAN, TITAN
BPR6EIX	BMW, CARTER, DNEPR, GAS GAS, KAWASAKI, KTM, LEM, MBK, MOTO GUZZI, MOTO-SPEZIAL, SANGLAS, SUZUKI, YAMAHA
BPR6HIX	ATALA, BAJAJ, BOSS, CAGIVA, DNEPR, HONDA, HYOSUNG, ISCH, ITALJET, KTM, KUANG YANG, LECSON, MALAGUTI, MARS, MOTOTECHNIKA, MZ, PEUGEOT, PGO, SACHS, SASY, SIAM, SIAMOTO, STEFFEN, SUZUKI, T.G.M. Bimota, TGB, YAMAHA
BPR7EIX	BETA, BMW, JCM, KAWASAKI, MONTESA, MOTO GUZZI, MOTO MORINI, SUZUKI, YAMAHA
BPR7HIX	AEON, BAROSSA MOTOR, BLANEY, BOMBARDIER, BSM, CAGIVA, CCF, DAREN, DINLI, DRR, DUCATI, E-TON, FANTIC, FOX, GARELLI, HERCULES, HERKULES, HYOSUNG, ISCH, ITALJET, KINETIC, KREIDLER, MANCO, MARS, MBK, MINSK, MOTOTECHNIKA, PEGASUS, PGO, POLARIS, REX, SACHS, SHE LUNG, SUZUKI, TGB, TOKAIDO, TRAILBLAZER, UNITED MOTORS, URAL AMERICA, YAMAHA, ZID
BPR8HIX	APRILIA, ITALJET, YAMAHA
BR10EIX	BETA, DERBI, GARELLI, KAWASAKI, SUZUKI, YAMAHA



BR6HIX	BAJAJ, BATAVUS, BENELLI, BMW, BOOM TRIKE, BULTACO, CARABELA, COSSACK, CZ, DKW, DUCATI, DUCSON, ERING, FANTIC, G.A.C. MobyLe., GARELLI, GILERA, HERCULES, HONDA, HUSQVARNA, JAWA, KREIDLER, KTM, KYMCO, LAMBRETTA, MAICO, MALAGUTI, MANCO, MBK, MECATECNO, MINARELLI, MONTESA, MOTO GEROSA, MOTO GUZZI, MOTOR HISPANIA, NSU, OMER, PEUGEOT, PIAGGIO, POLINI, PUCH, RIEJU, RIXE, RIZZATO, ROYAL ENFIELD, S.I.S., SACHS, SOLO, SPARTA, STARFLITE, TESTI, TORROT, VELOSOLEX, WINKING, YAMAHA, ZÜNDAPP
BR7HIX	ADLER, APRILIA, ATALA, ATK, BENELLI, BETA, BOOM TRIKE, BUFFALO, BULTACO, CAGIVA, CASAL, DERBI, DKW, DUCATI, DÜRRKOPP, FANTIC, G.A.C. MobyLe., HERCULES, HONDA, ITALJET, KAWASAKI, KREIDLER, KTM, K-ZWO, LEM, MACAL, MAICO, MALAGUTI, MBK, MONDIAL, MONTESA, MOTOR HISPANIA, MOTRON, MZ, NSU, PEUGEOT, PIAGGIO, POLINI, REGENT, RIXE, S.I.S., SACHS, SOLO, SUZUKI, TOMOS, TORROT, YAMAHA, ZÜNDAPP
BR8EIX	ALFER, APRILIA, ATK, B.S.A, BENELLI, BETA, BULTACO, CAGIVA, CARABELA, CCM, DERBI, FANTIC, GILERA, HARLEY-DAVIDSON, HM RACING, HONDA, HRD, KAWASAKI, KTM, LAVERDA, MBK, MINARELLI, MONTESA, MOTO GUZZI, MOTO KOSMOS, MSA, MV AGUSTA, OSSA, PEUGEOT, PIAGGIO, POLARIS, PUCH, RIEJU, RIZZATO, ROYAL ENFIELD, SACHS, SHERCO- HRD, SUZUKI, TESTI, TRIUMPH, YAMAHA, ZÜNDAPP
BR8HIX	ACCESS, ADLER, APRILIA, BENELLI, BETA, BMW, BS VILLA, CAGIVA, CASAL, CPI, DAELIM, DERBI, DKW, DÜRRKOPP, FITE (LEM), GARELLI, GAS GAS, HERCULES, HM RACING, HONDA, HYOSUNG, ITALJET, JAWA, KAWASAKI, KOLPIN, KREIDLER, KTM, KYMCO, LEM, MAICO, MALAGUTI, MBK, MONDIAL, MONTESA, MSA, MZ, MZ (TR), NSU, PEUGEOT, PUCH, RENAULT SPORT, RIXE, S.I.S., SACHS, SAN YANG, SIMONINI IMEA, SIMSON, SUZUKI, SYM, TESTI, UNISOM, UNITED MOTORS, VILLA BS, YAMAHA, ZÜNDAPP
BR9EIX	APRILIA, BETA, BLATA, BULTACO, CAGIVA, CCM, DERBI, FANTIC, GAS GAS, GILERA, HARLEY-DAVIDSON, HERCULES, HONDA, HUSQVARNA, ITALJET, KAWASAKI, KTM, MAICO, MALAGUTI, MBK, MONTESA, MOTO GUZZI, MOTO KOSMOS, MOTOR HISPANIA, OSSA, PIAGGIO, PUCH, RIEJU, SACHS, SUZUKI, TM, YAMAHA



ACCESS	BR8HIX
ADLER	BR7HIX, BR8HIX
AEON	BPR7HIX, CR7HIX, CR8HIX
AJP	DR8EIX
ALFER	BR8EIX, CR9EIX
AMERICAN IRON HORSE	BCPR5EIX-11, DCPR7EIX
APRILIA	BPR5EIX, BPR8HIX, BR7HIX, BR8EIX, BR8HIX, BR9EIX, CR7EIX, CR8EIX, DCPR9EIX, DR8EIX
ARCTIC CAT	CR7EIX, CR8EIX
ARGO	BKR5EIX
ATALA	BPR6HIX, BR7HIX
ATK	BR7HIX, BR8EIX, DR8EIX
B. S. A	BR8EIX
BAJAJ	BPR6HIX, BR6HIX
BAROSSA MOTOR	BPR7HIX, DR8EIX
BATAVUS	BR6HIX
BENELLI	BR6HIX, BR7HIX, BR8EIX, BR8HIX, CR7EIX, CR8EIX, CR9EIX, DR8EIX
BETA	BPR7EIX, BR10EIX, BR7HIX, BR8EIX, BR8HIX, BR9EIX, CR9EIX, DR8EIX
BIG DOG	BPR5EIX-11, DCPR7EIX
BIMOTA	CR9EIX, DPR8EIX-9, DR8EIX
BLANEY	BPR7HIX
BLATA	BR9EIX
BMW	BCPR7EIX, BKR7EIX, BKR7EIX + DCPR8EIX, BPR6EIX, BPR7EIX, BR6HIX, BR8HIX, CR8EIX, DCPR7EIX, DCPR8EIX, DR8EIX
BOMBARDIER	BPR7HIX, CR7HIX, CR8EIX, DCPR8EIX, DR8EIX
BOOM TRIKE	BPR5EIX, BR6HIX, BR7HIX

BOSS	BPR6HIX
BS VILLA	BR8HIX
BSM	BPR7HIX
BUELL	DCPR7EIX, DCPR9EIX
BUFFALO	BR7HIX
BULTACO	BPR5EIX, BR6HIX, BR7HIX, BR8EIX, BR9EIX
CAGIVA	BPR6HIX, BPR7HIX, BR7HIX, BR8EIX, BR8HIX, BR9EIX, CR7EIX, CR8EIX, DPR8EIX-9, DPR9EIX-9
CANNONDALE	CR9EIX
CARABELA	BR6HIX, BR8EIX
CARTER	BPR6EIX
CASAL	BR7HIX, BR8HIX
CCF	BPR7HIX
CCM	BPR5EIX, BR8EIX, BR9EIX, DR8EIX
COSSACK	BR6HIX
CPI	BR8HIX
CZ	BR6HIX
DAELIM	BR8HIX, CR8EIX-9
DAREN	BPR7HIX, DR8EIX
DAZON	CR7HIX, CR8EIX
DERBI	BR10EIX, BR7HIX, BR8EIX, BR8HIX, BR9EIX, CR9EIX, DPR8EIX-9
DINLI	BPR7HIX, CR7HIX
DKW	BR6HIX, BR7HIX, BR8HIX
DNEPR	BPR6EIX, BPR6HIX
DRR	BPR7HIX
DUCATI	BPR7HIX, BR6HIX, BR7HIX, DCPR8EIX, DPR8EIX-9, DR9EIX



DUCCSON	BR6HIX
DÜRRKOPP	BR7HIX, BR8HIX
EAT RACING	DCPR8EIX
EATV	DCPR8EIX
ERING	BR6HIX, CR7HIX
E-TON	BPR7HIX
FANTIC	BPR7HIX, BR6HIX, BR7HIX, BR8EIX, BR9EIX
FITE (LEM)	BR8HIX
FOX	BPR7HIX
G.A.C. Mobyle.	BR6HIX, BR7HIX
G+G	BKR7EIX
GARELLI	BPR7HIX, BR10EIX, BR6HIX, BR8HIX, CR7HIX
GAS GAS	BPR5EIX, BPR6EIX, BR8HIX, BR9EIX, CR8EIX
GILERA	BR6HIX, BR8EIX, BR9EIX, CR8EIX, CR9EIX, DPR8EIX-9, DPR9EIX-9, DR8EIX
HARLEY-DAVIDSON	BPR5EIX, BPR5EIX-11, BR8EIX, BR9EIX, DCPR7EIX, DPR7EIX-9, XR5IX
HERCULES	BPR7HIX, BR6HIX, BR7HIX, BR8HIX, BR9EIX
HERKULES	BPR7HIX, CR7HIX, CR8EIX, DR8EIX
HIGHLAND	CR8EIX
HM RACING	BR8EIX, BR8HIX
HONDA	BPR6HIX, BR6HIX, BR7HIX, BR8EIX, BR8HIX, BR9EIX, CR6HIX, CR7HIX, CR8EHIX-9, CR8HIX, CR9EHIX-9, DPR7EIX-9, DPR8EIX-9, DPR9EIX-9, DR8EIX, IFR5L11, IFR9H-11, IJR7A-9, IJR8B-9, IMR9C-9H, IMR9C-9HES
HRD	BR8EIX, CR9EIX
HUSABERG	CR8EIX, DCPR8EIX
HUSQVARNA	BR6HIX, BR9EIX, CR7EIX, CR8EIX

HYOSUNG	BPR6HIX, BPR7HIX, BR8HIX, CR8EHIX-9, CR8EIX, DR8EIX
INDIAN	BPR5EIX-11
ISCH	BPR6HIX, BPR7HIX
ITALJET	BPR6HIX, BPR7HIX, BPR8HIX, BR7HIX, BR8HIX, BR9EIX, CR7EIX, CR8EIX, DR8EIX
JAWA	BR6HIX, BR8HIX, DR8EIX
JCM	BPR7EIX
JOHN DEERE	BPR5EIX, DCPR8EIX
KARCHER	CR8HIX
KAWASAKI	BPR5EIX, BPR6EIX, BPR7EIX, BR10EIX, BR7HIX, BR8EIX, BR8HIX, BR9EIX, CR6HIX, CR7EIX, CR8EIX, CR8HIX, CR9EIA-9, CR9EIX, DPR7EIX-9, DPR8EIX-9, DPR9EIX-9, DR8EIX, DR9EIX
KINETIC	BPR7HIX
KOLPIN	BR8HIX
KREIDLER	BPR7HIX, BR6HIX, BR7HIX, BR8HIX, CR7HIX, DR8EIX
KTM	BPR6EIX, BPR6HIX, BR6HIX, BR7HIX, BR8EIX, BR8HIX, BR9EIX, CR8EIX, CR9EIX, DCPR8EIX, DPR8EIX-9, DPR9EIX-9, DR8EIX, DR9EIX
KUANG YANG	BPR6HIX
KYMCO	BR6HIX, BR8HIX, CR7HIX, CR8EIX, DPR7EIX-9, DR8EIX
K-ZWO	BR7HIX, CR7HIX
LAMBRETTA	BR6HIX
LAVERDA	BR8EIX, DPR8EIX-9, DPR9EIX-9, DR9EIX
LECSON	BPR6HIX
LEM	BPR6EIX, BR7HIX, BR8HIX
MACAL	BR7HIX
MAICO	BR6HIX, BR7HIX, BR8HIX, BR9EIX



MALAGUTI	BPR6HIX, BR6HIX, BR7HIX, BR8HIX, BR9EIX, CR7HIX, CR8EIX
MANCO	BPR7HIX, BR6HIX
MARS	BPR6HIX, BPR7HIX
MBK	BPR6EIX, BPR7HIX, BR6HIX, BR7HIX, BR8EIX, BR8HIX, BR9EIX, CR7EIX, CR8EIX
MECATECNO	BPR5EIX, BR6HIX
MERLIN	BPR5EIX
MIDWEST	CR6HIX
MINARELLI	BR6HIX, BR8EIX
MINSK	BPR7HIX
MONDIAL	BR7HIX, BR8HIX
MONTESA	BPR5EIX, BPR7EIX, BR6HIX, BR7HIX, BR8EIX, BR8HIX, BR9EIX
MOTO GEROSA	BR6HIX
MOTO GUZZI	BPR6EIX, BPR7EIX, BR6HIX, BR8EIX, BR9EIX, CR8HIX, DR8EIX, DR9EIX
MOTO KOSMOS	BR8EIX, BR9EIX
MOTO MORINI	BPR7EIX
MOTOR HISPANIA	BR6HIX, BR7HIX, BR9EIX
MOTO-SPEZIAL	BPR6EIX
MOTOTECHNIKA	BPR6HIX, BPR7HIX
MOTRON	BR7HIX
MSA	BR8EIX, BR6HIX
MV AGUSTA	BR8EIX, CR9EIX
MZ	BPR6HIX, BR7HIX, BR8HIX, CR7EIX, CR7HIX, CR8EIX, DPR9EIX-9, DR8EIX
MZ (TR)	BR8HIX
NORTON	CR8EIX

NSU	BR6HIX, BR7HIX, BR8HIX
OMER	BR6HIX
OSSA	BPR5EIX, BR8EIX, BR9EIX
PANDA	CR6HIX
PEGASUS	BPR7HIX, CR7HIX
PEUGEOT	BPR6HIX, BR6HIX, BR7HIX, BR8EIX, BR8HIX, CR8EIX
PGO	BPR6HIX, BPR7HIX, CR7HIX
PIAGGIO	BR6HIX, BR7HIX, BR8EIX, BR9EIX, CR7EIX, CR8EIX, CR9EIX
POLARIS	BKR5EIX, BKR6EIX, BKR7EIX, BPR7HIX, BR8EIX, DCPR8EIX
POLINI	BR6HIX, BR7HIX
PUCH	BR6HIX, BR8EIX, BR8HIX, BR9EIX, DPR9EIX-9
REGENT	BR7HIX
RENAULT SPORT	BR8HIX, CR9EIX
REX	BPR7HIX, CR7HIX, DR8EIX
RIEJU	BR6HIX, BR8EIX, BR9EIX, CR7HIX
RIXE	BR6HIX, BR7HIX, BR8HIX
RIZZATO	BR6HIX, BR8EIX
ROYAL ENFIELD	BR6HIX, BR8EIX
S. I. S.	BR6HIX, BR7HIX, BR8HIX
SACHS	BPR6HIX, BPR7HIX, BR6HIX, BR7HIX, BR8EIX, BR8HIX, BR9EIX, CR7HIX
SAN YANG	BR8HIX, CR7HIX
SANGLAS	BPR6EIX
SASY	BPR6HIX
SCORPA	BPR5EIX
SHE LUNG	BPR7HIX

